

NOTICE: This document contains references to Varian. Please note that Varian, Inc. is now part of Agilent Technologies. For more information, go to www.agilent.com/chem.



VS Series Helium Mass Spectrometer Leak Detectors

*MODELS: PR02, MR15, MD30, BR15, BD30 AND
PD03*

OPERATION MANUAL

Manual No. 699909942
Revision F
September 2010

VS Series Helium Mass Spectrometer Leak Detector



Contra-Flow is a trademark or registered trademark of Varian, Inc.

Alconox is a registered trademark of Alconox, Inc.

Apiezon is a registered trademark of M&I Materials Ltd.

Warranty

Products manufactured by Seller are warranted against defects in materials and workmanship for twelve (12) months from date of shipment thereof to Customer, and Seller's liability under valid warranty claims is limited, at the option of Seller, to repair, to replace, or refund of an equitable portion of the purchase price of the Product. Items expendable in normal use are not covered by this warranty. All warranty replacement or repair of parts shall be limited to equipment malfunctions which, in the sole opinion of Seller, are due or traceable to defects in original materials or workmanship. All obligations of Seller under this warranty shall cease in the event of abuse, accident, alteration, misuse, or neglect of the equipment. In-warranty repaired or replaced parts are warranted only for the remaining unexpired portion of the original warranty period applicable to the repaired or replaced parts. After expiration of the applicable warranty period, Customer shall be charged at the then current prices for parts, labor, and transportation.

Reasonable care must be used to avoid hazards. Seller expressly disclaims responsibility for loss or damage caused by use of its Products other than in accordance with proper operating procedures.

Except as stated herein, Seller makes no warranty, express or implied (either in fact or by operation of law), statutory or otherwise; and, except as stated herein, Seller shall have no liability under any warranty, express or implied (either in fact or by operation of law), statutory or otherwise. Statements made by any person, including representatives of Seller, which are inconsistent or in conflict with the terms of this warranty shall not be binding upon Seller unless reduced to writing and approved by an officer of Seller.

Warranty Replacement and Adjustment

All claims under warranty must be made promptly after occurrence of circumstances giving rise thereto, and must be received within the applicable warranty period by Seller or its authorized representative. Such claims should include the Product serial number, the date of shipment, and a full description of the circumstances giving rise to the claim. Before any Products are returned for repair and/or adjustment, written authorization from Seller or its authorized representative for the return and instructions as to how and where these Products should be returned must be obtained. Any Product returned to Seller for examination shall be prepaid via the means of transportation indicated as acceptable by Seller. Seller reserves the right to reject any warranty claim not promptly reported and any warranty claim on any item that has been altered or has been returned by non-acceptable means of transportation. When any Product is returned for examination and inspection, or for any other reason, Customer shall be responsible for all damage resulting from improper packing or handling, and for loss in transit, notwithstanding any defect or non-conformity in the Product. In all cases, Seller has the sole responsibility for determining the cause and nature of failure, and Seller's determination with regard thereto shall be final.

If it is found that Seller's Product has been returned without cause and is still serviceable, Customer will be notified and the Product returned at Customer's expense; in addition, a charge for testing and examination may be made on Products so returned.

This page intentionally left blank.

Table of Contents

Preface	xii
Documentation Standards	xii
Hazard and Safety Information	xiii
Varian Services	xxii
Contacting Varian	xxii
Section 1. Introduction to the VS Series Leak Detector	1-1
1.1 The VS Series Leak Detector	1-1
1.2 Unpacking the Leak Detector.....	1-5
1.2.2 Removing the Leak Detector from the Skid	1-6
1.3 Installation.....	1-8
1.3.2 Recommended Additional Services	1-11
1.3.3 Storage.....	1-11
1.4 Front Panel Display and Controls	1-12
1.5 Display Panel Controls.....	1-16
1.6 Rear Panel	1-18
1.7 Features.....	1-22
Section 2. Operating the Leak Detector	2-1
2.1 Initial Startup, High Pressure Test Setup, and Shutdown	2-1
2.1.2 High Pressure Test Set-Up Procedure.....	2-3
2.1.3 Shutdown	2-4
2.2 Screens.....	2-5
2.2.2 Home Screen	2-7
2.2.3 Control Panel Screen.....	2-12
2.2.4 Menus Screen	2-15
Section 3. Set-Up	3-1
3.1 Set-Up Menu	3-1
3.1.2 Manual Tuning	3-7
3.1.3 Manual Valve Control.....	3-10
3.1.4 Output Control.....	3-13
3.1.5 Units.....	3-15
3.1.6 Languages	3-16
3.1.7 Gauge Calibration	3-17
3.1.8 Maintenance.....	3-19
3.1.9 Password	3-24
3.1.10 Fore Pump Set-Up and Exhaust Pump.....	3-25
3.1.11 Wireless	3-27
3.1.12 System Defaults.....	3-29
Section 4. Maintenance	4-1
4.1 Daily Maintenance	4-5

VS Series Helium Mass Spectrometer Leak Detectors

4.2 Dry Nitrogen Vent	4-5
4.3 Spare Parts List	4-6
4.4 Leak Detector Accessory Item List	4-8
Appendix A. Communications Protocol	A-1
A.2 Communicating with RS-232	A-2
A.2.1 Windows HyperTerminal Set-Up Instructions	A-2
A.2.2 Printing with HyperTerminal	A-4
A.3 Customer Accessible Inputs and Outputs	A-14
A.3.1 Serial Connector	A-14
A.3.2 I/O Connector	A-14
Appendix B. Introduction to Leak Detection	B-1
B.2 Varian's Helium Leak Detection Technologies	B-1
B.3 Methods of Leak Testing	B-3
B.3.1 Vacuum Testing Method (Outside-in)	B-4
B.3.2 Pressure Testing Method (Inside-out)	B-5
B.3.3 System Leak Test Methods	B-6
B.4 Typical Leak Detection Applications	B-8
B.4.1 Quality Control of Production Parts and Assemblies	B-8
B.4.2 Maintenance of Systems	B-8
B.4.3 System Integrated Leak Detection	B-9
B.4.4 Mass Produced Parts	B-9
Appendix C. Specifications	C-1

List of Figures

Figure	Title	Page
1-1	Portable Leak Detector with Internal DS42 Wet Rotary Vane Pump, Model VS PR02, and Portable Leak Detector with Internal IDP-3 (PD03) Dimensions	1-3
1-2	Mobile Leak Detector with External DS302 Wet Rotary Vane Pump on a Cart, Model VS MR15, Dimensions.....	1-3
1-3	Mobile Leak Detector with External TS620 Dry Scroll Pump on a Cart, Model VS MD30, Dimensions	1-4
1-4	Bench Mount Leak Detector with External DS302 Wet Rotary Vane Pump, Model VS BRI5 . 1-10	
1-5	Bench Mount Leak Detector with External TS620 Dry Scroll Pump, Model VS BD30.....	1-10
1-6	Front Panel Displays and Controls	1-12
1-7	Screen Flow	1-15
1-8	VS Series Rear Panel.....	1-18
1-9	Optional I/O PCB Rear Panel	1-19
1-10	Rear Panel (with Discrete I/O PCB).....	1-21
2-1	Helium Background Timer	2-2
2-2	Home Screen	2-7
2-3	Gross Test Screen.....	2-9
2-4	Control Panel	2-12
2-5	Graphical Display.....	2-14
2-6	Menus Screen.....	2-15
2-7	Calibration Set-Up.....	2-16
2-8	Helium Background Timer	2-17
2-9	Reject and Audio Setpoints.....	2-18
2-10	Auto Sequencer	2-22
2-11	Leak Rate Ranging	2-24
2-12	Transfer Points.....	2-27
2-13	Transfer Points with Stabilization Wait Timer	2-28
2-14	System Information	2-29
2-15	Control Panel Access.....	2-31
3-1	Set-Up Screen - Initial.....	3-1
3-2	Set-Up Screen - Second.....	3-2
3-3	Advanced Parameters	3-3
3-4	Manual Tuning	3-7
3-5	Manual Valve Control.....	3-10
3-6	Manual Valve Control - PD03	3-11
3-7	Leak Detector Vacuum System Diagram.....	3-12
3-8	Output Control.....	3-13
3-9	Leak Detector Linear Output Voltage.....	3-14
3-10	Leak Detector Logarithmic Output Voltage	3-14
3-11	Units.....	3-15
3-12	Languages	3-16
3-13	Gauge Calibration	3-17

VS Series Helium Mass Spectrometer Leak Detectors

3-14	Maintenance	3-19
3-15	Vent Turbo Dialog.....	3-20
3-16	Current Date & Time Set-Up.....	3-21
3-17	Internal Calibrated Leak.....	3-22
3-18	Cal Leak Expiration Set-Up	3-23
3-19	Password Screen.....	3-24
3-20	Fore Pump Set-Up.....	3-25
3-21	Exhaust Pump	3-25
3-22	Date Serviced	3-26
3-23	Wireless	3-27
3-24	System Defaults Screen	3-29
A-1	Serial Connector Map	A-14
A-2	Optically Isolated Output Circuit Sketch	A-17
A-3	Optically Isolated Input Circuit Sketch	A-18
B-1	Magnetic Separation Principle	B-2
B-2	Selective Ion Pump Detector	B-3
B-3	Locating Leaks: Outside In	B-4
B-4	Measuring Leaks: Outside In	B-4
B-5	Measuring Leaks: Inside Out	B-5
B-6	Locating Leaks: Inside Out	B-5
B-7	Accumulation: Inside Out.....	B-6
B-8	Vacuum System.....	B-7

List of Tables

Table	Title	Page
1-1	VS Series Leak Detector Configurations and Part Numbers	1-2
1-2	Installation Requirements	1-8
1-3	Screens – General Description	1-16
1-4	VS Series Features.....	1-22
2-1	Screen Basic Functional Items	2-5
2-2	On-Screen Icons	2-6
2-3	Leak Detector Operating States.....	2-9
2-4	Leak Detector Condition States	2-10
2-5	Range Stop/Sensitivity Requirements	2-25
2-6	System Information Screen Conditions.....	2-29
3-1	Leak Detector Valve State Table - Single Mechanical Pump System	3-12
4-1	Scheduled Maintenance	4-3
4-2	As-Required Maintenance	4-3
4-3	Fuses and Circuit Breakers.....	4-4
4-4	Leak Detector Spare Parts.....	4-6
4-5	Leak Detector Accessory Item List	4-8

This page intentionally left blank.

We
Wir
Nous
Nosotros
Wij
Noi

CE DECLARATION OF CONFORMITY

Varian, Inc.
121 Hartwell Avenue
Lexington, MA, 02421-3133 USA



declare under our sole responsibility that the product,
erklären, in alleiniger Verantwortung, daß dieses Produkt,
déclarons sous notre seule responsabilité que le produit,
declaramos, bajo nuestra sola responsabilidad, que el producto,
verklaren onder onze verantwoordelijkheid, dat het product,
dichiariamo sotto nostra unica responsabilità, che il prodotto,

**VS Series Helium Mass Spectrometer Leak Detectors:
Models VS PR02x, VS MR15x, VS MD30x, VS BR15x, VS BD30x and VS PD03x
(With Optional Wireless Remote Control and Discrete I/O)**

to which this declaration relates is in conformity with the following standards:

Safety:

- EN 61010-1, Second Edition, 2001 - *Safety Requirements for Electrical Equipment for Measurement, Control, and Laboratory Use-Part 1: General Requirements*

per the provisions of the **Low Voltage Directive 73/23/EEC** of 19 February 1973 as Amended by 93/68/EEC, Article 13, of 22 July 1993.

- CAN/CSA-C22.2 No. 61010-1-04 - *Safety Requirements for Electrical Equipment for Measurement, Control, and Laboratory Use-Part 1: General Requirements* (Adopted IEC 61010-1:2001, MOD)
- UL 61010-1, Second Edition, 2004 - *Safety Requirements for Electrical Equipment for Measurement, Control, and Laboratory Use-Part 1: General Requirements*

EMC Emission and Immunity:

- EN 55011:1998/A1: 1999/A2: 2002 Group 1 Class A: *ISM radio-frequency equipment - Radio disturbance characteristics - Limits and methods of measurement (EU)*
- EN 61326:1997/A1: 1998 /A2:2001 *Electrical equipment for measurement, control and laboratory use - EMC requirements (EU)*

per the provisions of the **Electromagnetic Compatibility Directive 89/336/EEC** of 3 May 1989 as Amended by 92/31/EEC of 28 April 1992 and 93/68/EEC, Article 5 of 22 July 1993

- AS/NZS CISPR 11:2004 Class A: *ISM radio-frequency equipment - Electromagnetic disturbance characteristics - Limits and methods of measurement (Australia)*
- FCC: Code of Federal Regulations, 47CFR: 2004, Part 15C, Section 15.24, *Class A: Telecommunication, Radio Frequency Devices, Operation within the bands 902-928 MHz, 2400-2483.5 MHz, and 5725-5850 MHz (USA)*
- CAN/IC: Radio Standard Specification RSS-210, Issue 5, *for Low Power License- Exempt Radio communication Devices of Industry Canada*, November 2001 (Canada)

EMC and Radio Spectrum Matters:

- EN 300 328-1 V1.3.1 (2001-12) *Electromagnetic compatibility and Radio spectrum Matters (ERM): Wiband Transmission systems; Data transmitting equipment operating in the 2.4 GHz ISM band and using spread spectrum modulation techniques; Part 1: Technical characteristics and test conditions (EU)*
- EN 300 328-2 V1.2.1 (2001-12) *Electromagnetic compatibility and Radio spectrum Matters (ERM): Wiband Transmission systems; Data transmitting equipment operating in the 2.4 GHz ISM band and using spread spectrum modulation techniques; Part 2: Harmonized EN covering essential requirements under article 3.2 of R&TTE Directive (EU)*
- EN 301 489-1 V1.3.1 (2001-09) *Electromagnetic compatibility and Radio spectrum Matters (ERM): Electromagnetic Compatibility (EMC) standard for radio equipment and services: Part 1: Common Technical requirements (EU)*
- EN 301 489-17 V1.1.1 (2001-09) *Electromagnetic compatibility and Radio spectrum Matters (ERM): Electromagnetic Compatibility (EMC) standard for radio equipment and services: Part 17: Specific conditions for Wideband data and HIPERLAN equipment (EU)*

per the provisions of the **Radio and Telecommunications Terminal Equipment (R&TTE) Directive**, 1999/5/EC of 9 March 1999

The authorized representative located within Community is:

Varian Vacuum Technologies (Torino)
Varian S.p.A
Via F.lli Varian.54
Leini (Torino) - Italy
Tel: (39) 011 997 9 111
Fax: (39) 011 997 9 350

John Ehman

Operations Manager
Varian, Inc.
Lexington, Massachusetts, USA



Preface

Documentation Standards

This manual uses the following documentation standards:

NOTE



Notes contain important information.

CAUTION



Cautions appear before instructions, which if not followed, could cause damage to the equipment or data loss.

WARNING



Warnings appear for a particular procedure or practice which, if not followed correctly, could lead to serious injury or death.

Text













Hard buttons are depicted in text in **bold** text.

Soft key screen buttons are depicted in **bold** text when part of an action.

Italics is used for emphasis or to indicate screen text.

Hazard and Safety Information

The common international symbols used in this manual and on the equipment are defined below.

	OFF Supply (Power)		Earth (Ground) Terminal
	ON Supply (Power)		Caution, Hot Surface
	AC – Alternating Current		Caution, Risk of Electrical Shock
	Warning, Risk of danger		Protective Conductor Terminal
	Frame or chassis Terminal		Do Not Place in Trash
	Indoor, Dry Location Use Only		Caution, Radio Restriction

Operators and service personnel must be aware of all hazards associated with this equipment. They must know how to recognize hazardous and potentially hazardous conditions, and know how to avoid them. The consequences of unskilled, improper, or careless operation of the equipment can be serious. Every operator or service person must read and thoroughly understand operation/maintenance manuals and any additional information provided by Varian. All warning and cautions must be read carefully and strictly observed. Consult local, state, and national agencies regarding specific requirements and regulations. Address any safety, operation, and/or maintenance questions to your nearest Varian office.

Solvents

WARNING



The mechanical components of leak detectors are typically cleaned with alcohol, methanol, or other solvents.

When heated, sprayed, or exposed to high-temperature equipment, these solvents become flammable and explosive, causing serious injury or death. Do not use these solvents near a high-temperature source. Ventilate the working area with a blower and work in a large, well-ventilated room.

Alcohol, methanol, or other solvents are irritants, narcotics, depressants and/or carcinogens. Their inhalation and/or ingestion may produce serious side effects. Prolonged or continued contact with the skin results in absorption through the skin and moderate toxicity. Always ensure that cleaning operations are carried out in large, well-ventilated rooms, and wear eye shields, gloves, and protective clothing.

To clean the leak detector plastic enclosure, the LCD display and Front Panel buttons, use only a soft cloth slightly dampened with water or a mild soap.

Do NOT use excess water or cleaning solvents of any kind.

Avoid splashing any cleaning solvents into the unit through the ventilation openings or Front Panel buttons. Wipe the surface with a dry lint-free cloth.

CAUTION



Do not clean any aluminum parts with Alconox[®]. Alconox is not compatible with aluminum and will cause damage.

Vacuum Equipment and Cleanliness

Cleanliness is vital when servicing the leak detector or any vacuum equipment. There are some techniques that are more important in leak detector servicing than in general vacuum work:

CAUTION



Do not use silicone oil or silicone grease.

Use powder-free butyl or polycarbonate gloves to prevent skin oils from getting on vacuum surfaces.

NOTE



Varian does not recommend the use of vacuum grease. Vacuum grease absorbs helium tracer gas and releases this slowly resulting in helium background during leak test operations. If it must be used, use it sparingly and avoid silicone types. Apiezon[®] L grease is recommended (Varian Part No. 695400004).

O-ring Care

When removing, checking or replacing O-rings, keep in mind the following:



Varian recommends replacing all O-rings during routine maintenance or during any maintenance procedure requiring that O-rings be removed.



Due to the effective cleaning nature of VacuSolv solvent and its residue-free properties, Varian' Component and Spectrometer Cleaning Kit (Part Number 670029096), used in accordance with the kit instructions, is recommended for cleaning spectrometer components. The kit can also be used for fine cleaning of other parts in the leak detector's vacuum system such as valves and fittings. No rinsing steps or high-temperature drying are required following cleaning with VacuSolv. Although appropriate precautions are advised, VacuSolv is compatible with most materials and does not contain toxic chemicals or CFCs (chlorofluorocarbons). Other acceptable solvents are isopropyl alcohol (IPA) or Dow Corning[®] OS-20.

CAUTION



Remove O-rings carefully with your fingers. Do not use metal tools for this task; this prevents scratching of any sealing surfaces.

- Wipe all O-rings clean with a lint-free cloth before installation to ensure that no foreign matter is present to impair the seal.*
- Do not use grease or any other substance on O-rings that will come in contact with the spectrometer.*
- Do not use alcohol, methanol or other solvents on O-rings. Doing so causes deterioration and reduces their ability to hold a vacuum.*
- Varian does not recommend the use of vacuum grease. If applicable, apply a small amount of Apiezon[®] L grease and wipe the O-rings shiny dry.*

Metal Seal Care

CAUTION



Metal Seals must be replaced during routine maintenance or during any maintenance procedure required. All fasteners must be installed and torqued per assembly procedure specifications. Remove Metal Seals carefully with your fingers. Do not use metal tools for this task, this prevents scratching of any sealing surfaces. Wear non-powdered, ESD safe Nitride or equivalent gloves prior to removing or replacing Metal Seals.

- All Metal Seals come in clean room condition packages. No cleaning is required. If necessary, Metal Seals can be cleaned using alcohol or methanol. Wipe all Metal Seals clean with a lint free cloth before installation to ensure that no foreign matter is present to impair the seal.*
- Do not use grease or any other substance on Metal Seals that will come in contact with the spectrometer.*

Equipment, General

Environment of intended use:

- Indoors use in an industrial and laboratory installation only.*
- Altitude up to 2000m*
- POLLUTION DEGREE 2, Material group III*
- Operating Temperature: +12 °C to +45 °C, Relative Humidity (RH) up to 90% max.*
- Storage ambient conditions: RH from 0% to 95%, non-condensing, temperature: -20°C to +60°C*

WARNING



- Do not use in presence of flammable or explosive gas.*
- Do not attempt to disassemble or modify the equipment. Such action could lead to electric shock or injury. Varian's authorized technician will do any repair work.*
- If there is smoke or unusual smell or noise, stop the using the equipment immediately, and contact the Varian Service Center.*

WARNING



The leak detector is not designed for use with hazardous gases. Verify that the system to be tested has been purged of all hazardous gases prior to using the leak detector. When testing a system that contained hazardous gases, connect the exhaust of the leak detector to a scrubbed or toxic containment exhaust. Exposure to hazardous gases could result in serious injury or death.

VS Series Helium Mass Spectrometer Leak Detectors

WARNING



Equipment tightness is guaranteed for normal operating conditions when the equipment leaves the factory. It is the user's responsibility to maintain the level of tightness, particularly when pumping dangerous products.

CAUTION



The performance and operating safety of this equipment can only be guaranteed if it is operated according to normal conditions of use.

Allow at least 4" of clearance adjacent to the ventilation slots at the front, sides and back of the equipment enclosure.

Allow sufficient room for the operator to safely maneuver to perform testing.

LCD Display

WARNING



If the LCD display breaks, avoid getting any liquid crystal in mouth or eyes. If it gets on the operator hands, feet or clothing, wash it immediately with soap and water.

CAUTION



Do not apply excessive pressure to the LCD display as this may cause smears.

In general, the lower the temperature, the longer it takes the LCD display to turn on. Performance of the LCD display may deteriorate in low temperature.

Radio

The Wireless Remote Control is built around an Aerocomm, model AC4424-100, RF transceiver module operating in 2.4 GHz ISM band. The same type of the RF module is built in a VS Series Leak Detector Wireless Base Station PCB and Wireless Remote unit (see *VS Series Leak Detector Wireless Remote Operational Manual* (6999099945A)).

Agency Identification Numbers for Aerocomm, Model AC4424-100:

- US/FCC ID: KQL-AC4424
- CAN/IC: CAN2268C391190A
- EUR/EN: CE

are also applied to the Varian's Wireless Remote and VS Series Leak Detector Wireless Base Station, when the units are used the approved antennas.

VS Series Helium Mass Spectrometer Leak Detectors

WARNING



The Wireless Remote complies with Part 15 of the FCC Rules. Operation is subject to the following two conditions: (1) This device may not cause harmful interference, and (2) This device must accept any interference received, including interference that may cause undesired operation.

To satisfy FCC RF exposure requirements for mobile type transmitting devices, maintain a separation distance of 20 cm or more between the antenna of the Wireless Remote and persons during operation, with exception of hands, wrist, feet, and ankles. To ensure compliance, operations at closer distance than this distance are prohibited.

Maintain a separation distance of 20 cm or more between the operator and the RF antenna of the VS Series leak detector with a wireless base station.

CAUTION



Use only approved type of antennas for:

- Wireless Remote: Centurion, Model WCP2400-MMCX2, www.centurion.com.
- VS Series Leak Detector Wireless Base Station, Nearson, Model S181FL-5-RMM- 2450S, www.nearson.com

Power and Static Sensitivity

WARNING



Depending on the unit configuration ordered, the mains power supply requirements for VS Series leak detectors are:

- 100 VAC, 50 Hz, 20 A
- 115 VAC, 60 Hz, 20 A or
- 230 VAC, 50/60 Hz, 12 A

Before powering the unit for the first time, verify that the unit is configured to operate for the local mains supply voltage.

VS Series Helium Mass Spectrometer Leak Detectors

CAUTION



Use surge protection to improve the immunity of the leak detector against unidirectional transients caused by the following phenomena:

- Switching phenomena in the power network (e.g., switching of capacitor banks, inductive loads, electrical motors, etc.)*
- Faults in the power network*
- Indirect lightning strokes*

CAUTION



Many components of the leak detector are static sensitive. Wear a grounding device when performing any maintenance on the leak detector, especially when performing maintenance of static sensitive parts, such as circuit boards and the spectrometer.

CAUTION



This equipment has been tested and found to comply with the limits for Class A digital device, pursuant to Part 15 of FCC Rules. These limits are designed to provide reasonable protection against harmful interference when it is operated in a commercial environment.

This equipment generates, uses, and can radiate RF energy, which if not installed and used in accordance with the instructional manual, can cause harmful interference to radio communications.

When this equipment is operated in a commercial environment, operation is subject to the following two conditions:

- This equipment must not cause harmful interference.*
- This equipment must accept any interference received, including interference (RF and ESD) that may cause undesired operation.*

The equipment may need to be reset after RF and/or ESD events by cycling the Power Switch/Circuit Breaker on the back panel of the unit.

Operation of this equipment in a residential area is also likely to cause harmful radio communications interference, in which case, the users will be required to correct the interference at their expense.

WARNING



This equipment is designed to meet current EEC regulations: LVD (Low Voltage Directive, 73/23/EEC:1993) and EMC (Electromagnetic Compatibility Directive, 89/336/EEC:1993) for Material Group III, Pollution Degree 2 environment for Industrial, Scientific, Measuring and Process Control Electrical Equipment and R&TTE (Radio and Telecommunications Terminal Equipment Directive, 199915/EC:1999)

- Any modifications on the part of the user are liable to cause non-compliance with regulations or affect the EMC performance and the safety of the product. Varian cannot be held responsible for consequences resulting from such intervention.*
- Before powering the unit the first time, verify that the unit is configured to operate for the local mains supply voltage.*
- The equipment can be damaged by:*
 - Incorrect mains AC supply voltages*
 - Radio Frequency (RF) and Electrostatic Discharge (ESD) energy inputs that exceed the maximum ratings*
 - Operating in very high temperatures or without adequate ventilation*
 - Immersion in liquids*
 - Physical abuse*
- All electrical connections must be performed by a qualified electrician and must comply with national and local codes.*
- Opening the enclosure may expose hazardous voltages. Always disconnect the power cord and interface cables before opening the enclosure. Do not touch the power inlet's contacts for at least 10 seconds after disconnecting the power cord.*
- Electrical installation must include the appropriate branch circuit (20 A maximum), with a long time delay and a reliable earth ground.*
- Use only the power cord that was provided with your leak detector. The use of extension cords is not recommended and could result in damage to the equipment and loss of warranty.*
- To avoid electric shock, connect the product power cord to a grounded power receptacle. A power cord with a grounding conductor is required.*

VS Series Helium Mass Spectrometer Leak Detectors

Spectrometer

WARNING



Store the Ion Source/Preamplifier sub-assembly in a cool, dry area in a tightly sealed, ESD protected container. Wear lint-free gloves when handling the spectrometer. Wash hands thoroughly after handling the spectrometer filaments and especially before smoking or eating.

CAUTION



The spectrometer operates at a very high vacuum produced by the high vacuum pump. Service of the spectrometer requires that this vacuum be vented to the atmosphere.

CAUTION



Do not use grease or any other substance on O-rings or metal seals that will come in contact with the spectrometer.

CAUTION



If the spectrometer magnet comes in contact with a magnetic surface, the magnet can become degraded causing the spectrometer to lose sensitivity.

Pumps

WARNING



To avoid injury, use proper lifting techniques when moving pumps. Two people may be required to move pumps safely.

WARNING



The vacuum pumps are also compressors; incorrect operation may be dangerous. Study the Mechanical Pump Operation Manual enclosed with your pump before starting pumps.

The pumps are designed to prevent any thermal risk for user safety. However, specific operating conditions may generate temperatures $>70^{\circ}\text{C}$.

Hot oil burns the skin. Service of the pumps in this area must be performed by authorized personnel only. Stand back from a mechanical pump before starting it.

VS Series Helium Mass Spectrometer Leak Detectors

WARNING



To avoid injury, wait until the turbo pump is completely stopped before disconnecting it from the vacuum system.

To vent the turbo, use the system vent function described in Section 3.1.8.1 "Turbo Vent" on page 3-20.

CAUTION



*Check the oil level often. Do not allow oil-based mechanical pumps to run when the oil level is below the **LOW** mark.*

Damage to pumps can occur if operated with no oil, if the oil level is too high or if the oil has become discolored.

Varian Services

Varian offers:

- Rebuilt spectrometers on an exchange basis.
- NIST-traceable calibrated leak testing and verification services.
- Preventive maintenance services.
- Overhaul services.
- System recertification.
- Support agreements.
- On-site support.

Please see our catalog or contact us to learn about available services.

Contacting Varian

See the back cover of this manual for a listing of our sales and service offices.

Internet users:

- Send email to Customer Service and Technical Support at vtl.customer.service@varianinc.com
- Visit our web site at www.varianinc.com/vacuum
- Order on line at www.evarian.com

Section 1. Introduction to the VS Series Leak Detector

1.1 The VS Series Leak Detector

The VS Series is a wide-range Helium Mass Spectrometer Leak Detector, which is comprised of a turbo molecular high vacuum pump, internal mechanical rough pump (model VS PR02), internal scroll pump (model PD03), external mechanical rough pump (models VS MR15, VS MD30, VS BR15 and VS BD30), spectrometer tube, valve block, leak detector electronics, an operator interface (TFT-LCD display with a touch panel and two hard buttons: TEST and VENT), and optional features, including:

- ❑ Wireless remote control that includes:
 - ❑ Wireless Base PCB (P/N R2541301) installed in a VS leak detector
 - ❑ Wireless Remote unit (P/N R3000301).
- ❑ Optional I/O PCB (P/N R2111301).

Both models VS MR15x and VS MD30x include an optional two-wheel cart.

All models are available in 100/115 VAC and 230 VAC configurations (see Table 1-1 on page 1-2).

The wireless remote control has the following capabilities:

- ❑ RF communication between VS leak detector (Base Station or Host) and the Wireless Remote unit from the distance up to 100 m (300 ft).
- ❑ Enter the VS leak detector unit into Test and Hold modes from the Wireless Remote unit keypad.
- ❑ Read the VS leak detector unit's leak rate in a linear and logarithmic bar graph format with a numeric range indicator and System status in alphanumeric format on the Wireless Remote unit LCD display.
- ❑ Configure up to ten different VS leak detector units for wireless control by toggling through a MAC address list using one Wireless Remote unit.

The optional I/O PCB comprises:

- ❑ Optically isolated parallel I/O (DB25 female connector with 12 output and 8 input lines) to use with an external PLC and should be powered by the user (+5-24 VDC) via a cable with length less than 10' and provided by the user (see Appendix A.3.2 "I/O Connector" on page A-14).

VS Series Helium Mass Spectrometer Leak Detectors

CAUTION



The usage of a longer cable for the parallel I/O output connection with an external PLC is fully responsibility of the user. Some EMC prevention measure may be required by the user

- ❑ USB HUB with two downstream type A connectors and one upstream type B connector.

NOTE



USB features are SW disabled in this release.

Table 1-1 VS Series Leak Detector Configurations and Part Numbers

Model Number	Varian P/N	Mains Voltage	Vacuum Pump System		Configuration	Two Wheel Cart
			Internal	External		
VS PR02	VSPR021	100/115 VAC	DS-42	N/A	Portable	N/A
	VSPR022	230 VAC				
VS MR15	VSMR151	100/115 VAC	N/A	DS302	Mobile	Yes
	VSMR152	230 VAC				
VS MD30	VSMD301	100/115 VAC	N/A	TS620	Mobile	Yes
	VSMD302	230 VAC				
VS BR15	VSMR151	100/115 VAC	N/A	DS302	Bench Mount	N/A
	VSBR152	230 VAC				
VS BD30	VSBD301	100/115 VAC	N/A	TS620	Bench Mount	N/A
	VSBD302	230 VAC				
VS PD03	VSPD030	110 VAC	IDP-3	N/A	Portable	N/A
	VSPD031	115 VAC				
	VSPD032	220 VAC				

Outline drawings for each configuration are shown in Section 1.1.1 “VS Series Leak Detector Configurations”.

VS Series Helium Mass Spectrometer Leak Detectors

1.1.1 VS Series Leak Detector Configurations

This section contains outline drawings of the leak detector configurations. Dimensions are given in inches, in brackets, and in mm, below the brackets.

Figure 1-1 shows the outline drawing and physical dimensions of the portable leak detector with Internal DS42 Wet Rotary Vane Pump, Model VS PR02 and the PD03, which utilizes a Varian IDP-3 dry pump.

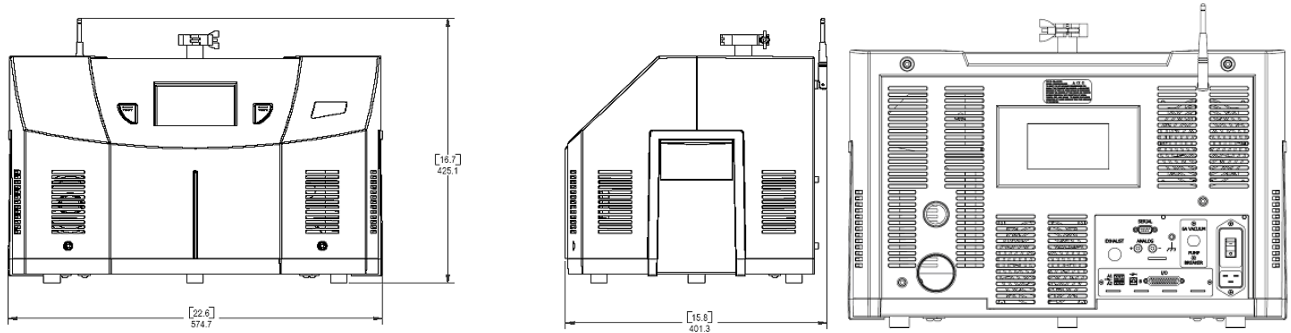

Figure 1-1 Portable Leak Detector with Internal DS42 Wet Rotary Vane Pump, Model VS PR02, and Portable Leak Detector with Internal IDP-3 (PD03) Dimensions

Figure 1-2 shows the outline drawing and physical dimensions of a mobile leak detector with External DS302 Wet Rotary Vane Pump on a Cart, Model VS MR15.

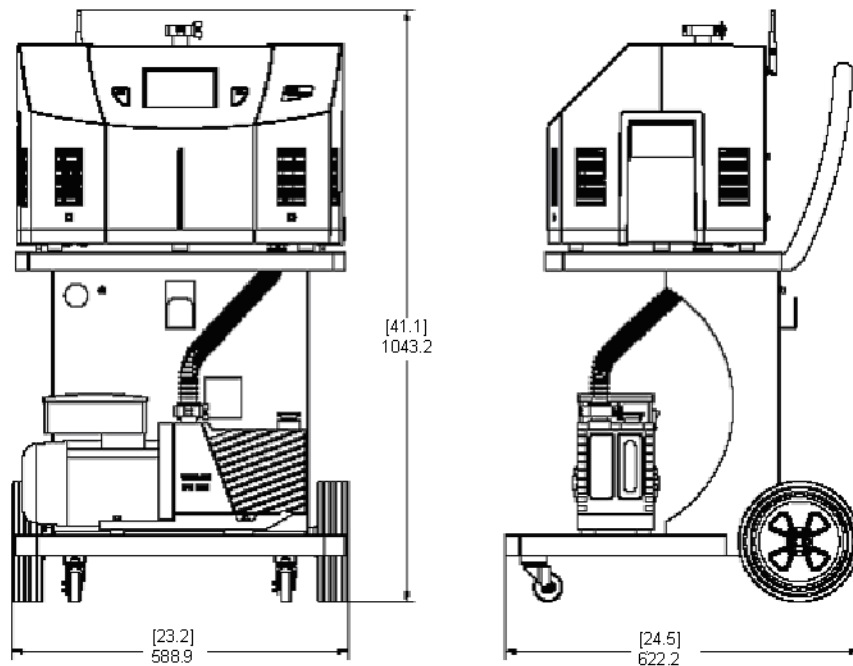

Figure 1-2 Mobile Leak Detector with External DS302 Wet Rotary Vane Pump on a Cart, Model VS MR15, Dimensions

VS Series Helium Mass Spectrometer Leak Detectors

Figure 1-3 shows the outline drawing and physical dimensions of a Mobile Leak Detector with External TS620 Dry Scroll Pump on a Cart, Model VS MD30.

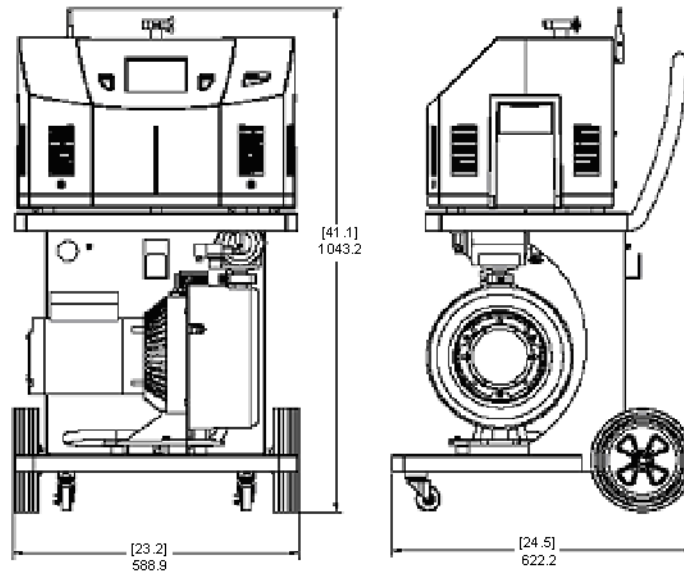

Figure 1-3 Mobile Leak Detector with External TS620 Dry Scroll Pump on a Cart, Model VS MD30, Dimensions

1.2 Unpacking the Leak Detector

The following items are included in the shipment:

- ❑ VS Series Helium Mass Spectrometer Leak Detectors Operations Manual
- ❑ VS Series leak detector configured and completely assembled as ordered
- ❑ All necessary power cords, as ordered
- ❑ Pump manuals (for the purchased configuration)
- ❑ Any optional equipment ordered
- ❑ Any manuals for optional equipment purchased

1.2.1 Unpacking Instructions

To unpack the leak detector and remove it from the skid:

1. Inspect the container for evidence of damage in shipment.
 - a. Do not discard evidence of rough handling.
 - b. Report the damage to the carrier and to Varian Customer Service without delay. See the back cover of this manual for a listing of our sales and service offices.
2. Wear safety glasses and carefully cut the outer container holding straps.
3. Carefully remove the outer shipping container.
4. Inspect the leak detector and related items immediately for any indication of shipping damage.
5. Carefully cut the leak detector holding straps.
6. Remove any loose boxes or packages and put them aside.

Keep the original packing for re-use in the event that it is necessary to return the leak detector to Vacuum Technologies.
7. Carefully remove the plastic bag covering the leak detector.

Proceed to Section 1.2.2 "Removing the Leak Detector from the Skid".

1.2.2 Removing the Leak Detector from the Skid

There are three methods for removing the leak detector from the skid, depending on the leak detector model ordered. All methods require two people. The third method involves removing the *Skid-Mates* (the blue donut-shaped mounts at the front of the skid) from the skid.

WARNING



Handle the leak detector carefully and properly in the following steps. Personal injury or damage to the leak detector could result from improper handling. The leak detector is heavy and can cause personal injury if not handled carefully when removing it from the skid.

For portable and bench mount leak detectors (PD, PR, BR and BD models):

Method 1

1. With the assistance of a helper (one person per side), carefully lift the leak detector off the skid using the leak detector side handles.

CAUTION



Keep the leak detector relatively horizontal when lifting. Lifting the leak detector at a severe angle could cause oil to spill in units with oil-sealed mechanical pumps installed.

2. Gently place the leak detector on a designated flat surface.
3. Remove all loose packing from around the leak detector.

For mobile leak detectors (PD, PR, MR and MD models):

Method 2

1. With the assistance of a helper, carefully roll the leak detector toward the front of the skid.
2. Lift the front end of the unit and *gently* lower it onto the floor.
3. Lift the rear of the unit and roll it on the front casters until it is clear of the skid.
4. *Gently* lower the rear end onto the floor.
5. Take out and remove all loose packing from the leak detector.

VS Series Helium Mass Spectrometer Leak Detectors

Method 3

1. Using a lever, carefully raise the front edge of the skid between 1" and 2".
2. While a helper holds the leak detector against the back brace, unscrew and remove the front two Skid-Mates by turning them in a counterclockwise direction.
3. Make sure the helper is still holding the leak detector against the back of the skid, then gently lower the front of the skid to the floor.
4. Carefully and slowly roll the leak detector off the skid and onto the floor.
5. Take out and remove all loose packing from the leak detector.

1.3 Installation



CAUTION

Read the Preface for all operational warnings and cautions.



The VS Series Leak Detector is delivered completely assembled as ordered. Installation requirements are described in Table 1-2.

Table 1-2 Installation Requirements

Item	Requirement
Leak Detector Location	<ul style="list-style-type: none"> <input type="checkbox"/> Close to its power source. <input type="checkbox"/> Four inch clearance for proper ventilation. <input type="checkbox"/> Sufficient room for the operator to safely maneuver to perform testing. <p> <i>Additional ventilation requirements for your specific application are discussed in Section 1.3.2 "Recommended Additional Services" on page 1-11.</i></p> <p> <i>When installing a bench system with a mechanical pump, the power cord for that pump, if connected to the back of the leak detector, cannot exceed three meters. Additionally, connect the mechanical pump to the leak detector using the shortest possible vacuum connection to maximize vacuum performance.</i></p>
Power	<p>Either (depends on configuration ordered):</p> <ul style="list-style-type: none"> <input type="checkbox"/> 100 VAC, 50 Hz, 20 A <input type="checkbox"/> 115 VAC, 60 Hz, 20 A or <input type="checkbox"/> 230 VAC, 50/60 Hz, 12 A (models PR, MR and MD) <input type="checkbox"/> 230 VAC, 50 Hz, (model PD03)

VS Series Helium Mass Spectrometer Leak Detectors

Table 1-2 Installation Requirements (Continued)

Item	Requirement
Mechanical Pump Oil Level	<p>Oil-sealed mechanical vacuum pumps are shipped with the proper initial charge of oil. The oil level sight glass is on the front of the pump.</p> <ul style="list-style-type: none"> <input type="checkbox"/> In the middle of the glass when the pump is not running. <input type="checkbox"/> Check the oil level after running the pump for at least 10 minutes. <div style="display: flex; align-items: center; margin-top: 10px;"> <div style="border: 2px solid black; padding: 5px; margin-right: 10px;">  </div> <div> <p><i>See the Mechanical Pump Operation Manual that was enclosed with your pump.</i></p> </div> </div>
Mains Supply Voltage Fluctuations	Must not exceed $\pm 10\%$ of the nominal voltage.
Pollution	Pollution Degree 2 per EN61010-1 Standard.
Fixed Mains Socket Outlet	Connect to a building protective earthing system.

VS Series Helium Mass Spectrometer Leak Detectors

1.3.1 Bench System Installations

Figure 1-4 and Figure 1-6 represent the process for installation of the bench system version of the VS Series Leak Detector.

Figure 1-4 is a drawing of a Bench Mount Leak Detector with External DS302 Wet Rotary Vane Pump, Model VS BR15 with individual components shown.

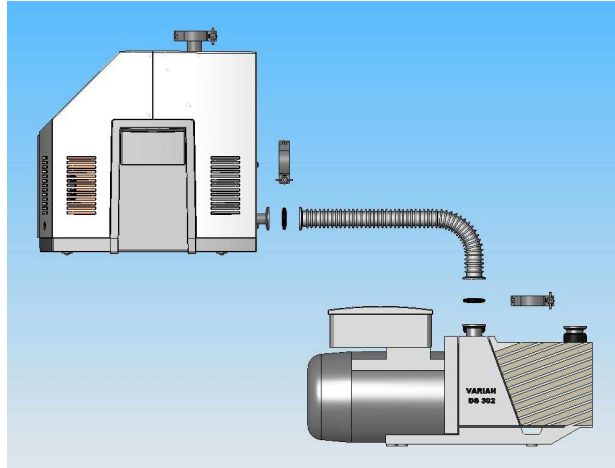

Figure 1-4 Bench Mount Leak Detector with External DS302 Wet Rotary Vane Pump, Model VS BR15

Figure 1-5 is a drawing of a Bench Mount Leak Detector with External TS620 Dry Scroll Pump, Model VS BD30 with individual components shown.*

NOTE



Cut the 3/4" black tubing into two equal parts as shown.

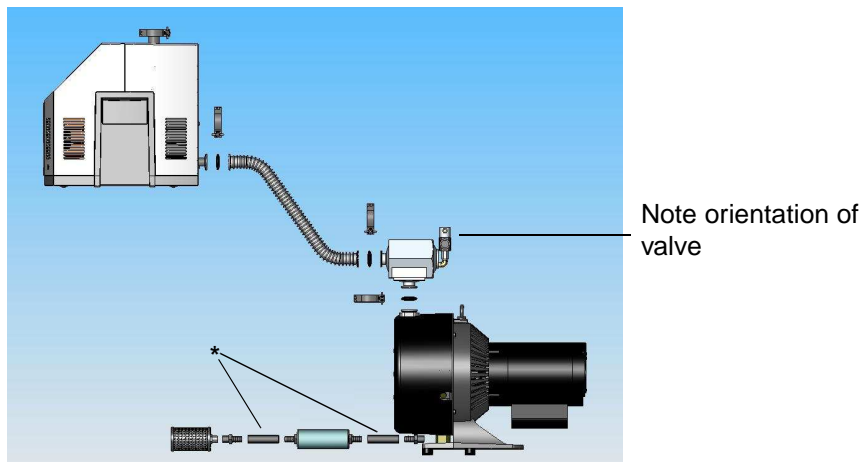

Figure 1-5 Bench Mount Leak Detector with External TS620 Dry Scroll Pump, Model VS BD30

1.3.1 Helium

Welding grade helium in a standard cylinder with pressure regulating valve and hose is required for testing products and leak checking.

1.3.2 Recommended Additional Services

The following additional services are recommended, based on the application:

- ❑ Connect an exhaust hose to the foreline pump and vent it outside of the room, or to the facility's exhaust, to reduce the particulate count and the helium background signal.
- ❑ When using oil lubricated mechanical pumps, use an oil mist eliminator on the exhaust port of the mechanical pump to reduce the oil mist from the exhaust.
Oil mist eliminators can, however, become saturated with oil causing slower pumping speeds and higher helium backgrounds in the leak detector. The replacement time interval of the oil mist eliminator is determined by whether the user frequently operates at elevated roughing pressures, pumps on large volumes, or frequently cycles the system. Refer to Table 4-4 on page 4-6 and Table 4-5 on page 4-8 for the mist eliminator and replacement cartridge part number.
- ❑ Dry nitrogen vent to keep the test port dry. Refer to Section 4.2 on page 4-5 for more information.
- ❑ Adequate circulation to prevent an increased helium background level.

1.3.3 Storage

If the VS Series leak detector is not used immediately, it can be stored as received without special precautions. A dry, relatively dust-free area is preferred. The required environmental conditions for storage are:

- ❑ 0% to 95% relative humidity, non-condensing
- ❑ -20 °C (-4 °F) to + 60 °C (+ 140 °F) ambient temperature

CAUTION



Never leave any type of cell in the Wireless Remote unit if it is will not be in use for a long period of time.

1.4 Front Panel Display and Controls

The front panel (Figure 1-6) consists of two *hard* buttons: **TEST** and **VENT** and an LCD display to access the software control screens. All operator control and monitoring of results are achieved via the resident software accessed using the Home screen. Table 1-3 on page 1-16 lists the main sub-screens and their purpose. Operational discussions are in Section 2 “Operating the Leak Detector” on page 2-1 and in Section 3 “Set-Up”.

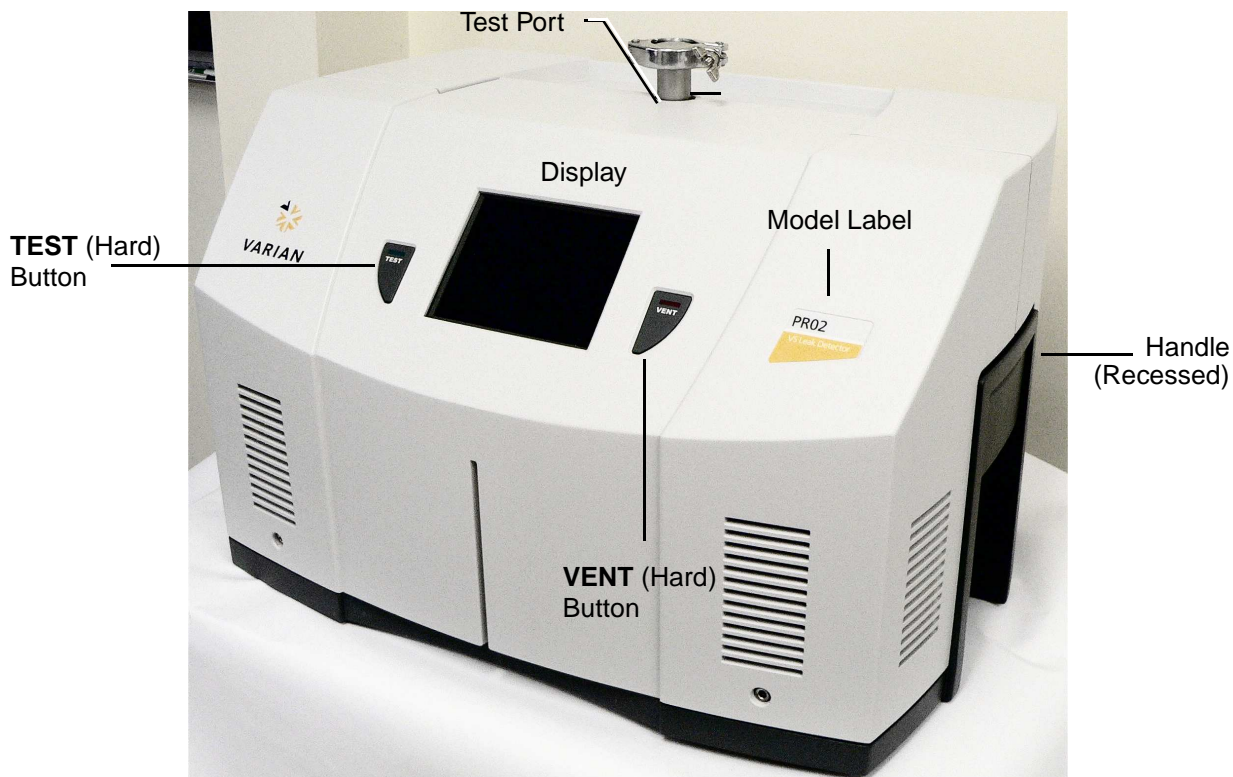

Figure 1-6 Front Panel Displays and Controls

The front panel display touch panel is calibrated at the factory and should not require recalibration. If the touch panel buttons do not respond to pushes, recalibrate as follows:

1. Turn off the leak detector power.
2. Press and hold the center of the touch panel and restart power.
A blue screen appears.
3. Press the four cross hairs on the screen and accept the calibration.

VS Series Helium Mass Spectrometer Leak Detectors

LCD Display

Represents:

- Leak Rate - in a Bar Graph format with a numeric range indicator
- Leak Rate, System Status and Parameters - in alphanumeric format
- Series of screens with the soft key buttons for operator interface

Leak Rate, System Status and Parameters in alphanumeric format:

- Leak Rate is presented in a scientific notation: $XXE-YY$ with appropriate units
Where: X.X mantissa is a leak rate value
E- Y = 10-YY exponent is a leak rate range
X and Y are any numbers from 0 to 9
- System Status and/or Mode are represented on the screen in alpha format on the screen and an italic font in this manual
- Parameters are represented on the screen in alphanumeric format a bold font in this manual.

Leak Rate Bar Graph

The large bar graph displays the leak rate in one of three forms:

- A linear bar graph
- A logarithmic bar graph
- Both linear and logarithmic bar graphs

Use the Output Control Set-Up screen (Section 3.1.8.3.1 "Cal Leak Expiration Set-Up" on page 3-23) to change the type of bar graph that appears.

Over-range and under-range conditions are indicated using two up and down arrows on the right and left side of the bar graph, respectively.

VENT

The **VENT** button advances the leak detector to the vented state. A red LED illuminates while the leak detector is in the vented state.

TEST

When the system is in the Vent or Hold states, pressing the **TEST** button automatically advances the leak detector through roughing, then through the various test states, depending on the achievable test port pressures and leak rates. A green **TEST** LED in the button illuminates when the leak detector is in the Test or Fine Test state.

Press the **VENT** button to isolate the test port from the leak detector vacuum system and vent the test port to atmosphere. The red **VENT** LED remains lit while the leak detector is in the vented state. To activate the VENT function, press and hold **VENT** for one second.

VS Series Helium Mass Spectrometer Leak Detectors

HOLD

With the leak detector in Test/Fine Test mode, press TEST again and the leak detector goes into HOLD mode, isolating the leak detector from the unit under test. The green LED in the Test button won't illuminate and the Home Screen displays *Hold*.

VS Series Helium Mass Spectrometer Leak Detectors

The leak detector operator interface functions through a series of screens, which are navigated as in Figure 1-7.

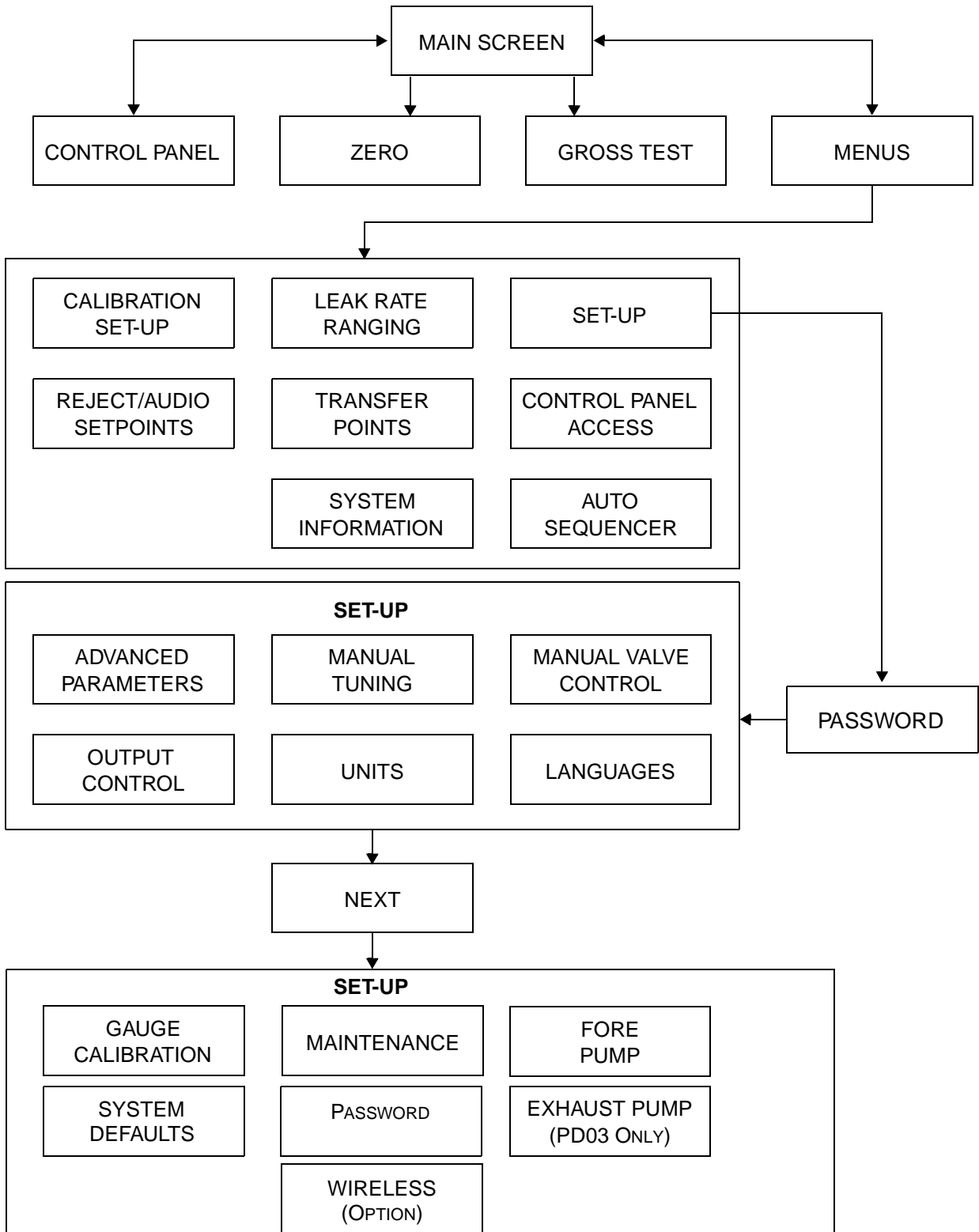

Figure 1-7 Screen Flow

1.5 Display Panel Controls

Table 1-3 Screens – General Description

Screen	Purpose
Home	<p>Accesses the Control Panel and Menu screens.</p> <p>Activates the Zero function. The LED illuminates while zeroing occurs.</p> <p>Accesses the Gross Leak Test screen, when Gross Test is initiated.</p>
Control Panel	<p>Activates/deactivates:</p> <ul style="list-style-type: none"> <input type="checkbox"/> Std Leak <input type="checkbox"/> Zero Enable <input type="checkbox"/> Hold <input type="checkbox"/> Calibrate <p>Displays the type of leak: Internal or external, associated with Calibrate.</p> <p>Adjusts the speaker volume.</p>
Menus	<p>Accesses the following screens for tailoring leak detector operation:</p> <ul style="list-style-type: none"> <input type="checkbox"/> Calibration Set-Up – Configures leak type, mode and parameters (Section 2.2.4.1 on page 2-16). <input type="checkbox"/> Reject & Audio Set Points – Configures parameters and toggles operations on/off for each reject set point and for the audio threshold (Section 2.2.4.2 on page 2-18). <input type="checkbox"/> Leak Ranging – Configures the Range Stop, Manual Range values, toggles the high pressure test feature and toggles operations on/off (Section 2.2.4.4 on page 2-24). <input type="checkbox"/> Transfer Pressure – Configures the Maximum Test Pressure (Section 2.2.4.5 on page 2-27). <input type="checkbox"/> System Information – Displays the status of configured and active items (Section 2.2.4.6 on page 2-29). <input type="checkbox"/> Control Panel Access – Activates/deactivates Vent and Panel Lockouts (Section 2.2.4.7 on page 2-31). <input type="checkbox"/> Auto Sequencer – Configures roughing and test times, toggles features on/off and displays rough timer value (Section 2.2.4.3 on page 2-21). <input type="checkbox"/> Set-Up - Accesses all the screens shown in Figure 1-7 on page 1-15.

VS Series Helium Mass Spectrometer Leak Detectors

Table 1-3 Screens – General Description (Continued)

Screen	Purpose
Set-Up	<p>Accesses the following screens:</p> <ul style="list-style-type: none"> <input type="checkbox"/> Advanced Parameters: <ul style="list-style-type: none"> <input type="checkbox"/> Activates Autozero and Split Flow functions. <input type="checkbox"/> Activates the Gross Leak function (Section 3.1.1 “Advanced Parameters” on page 3-3). <input type="checkbox"/> Sets Split Flow value (Section 3.1.1 on page 3-3). <input type="checkbox"/> Output Control – Configures the Analog Output and Bar Graph default units (Section 3.1.8.3.1 on page 3-23). <input type="checkbox"/> Manual Tuning: <ul style="list-style-type: none"> <input type="checkbox"/> Toggles between Filament 1 and 2. <input type="checkbox"/> Sets Emission, Ion and Gain settings (Section 3.1.2 on page 3-7). <input type="checkbox"/> Units – Configures Leak Rate and Pressure units (Section 3.1.5 on page 3-15). <input type="checkbox"/> Manual Valve Control – Access to control all valves (Section 3.1.3 on page 3-10). <input type="checkbox"/> Languages – Configures language (Section 3.1.6 on page 3-16). <input type="checkbox"/> Gauge Calibration – Calibrates the Test Port Vacuum and Test Port ATM reference points and displays Test Port Pressure and Spectrometer Pressure (Section 3.1.7 on page 3-17). <input type="checkbox"/> Maintenance – Configures: <ul style="list-style-type: none"> <input type="checkbox"/> Date and Time (Section 3.1.8.2 on page 3-21) <input type="checkbox"/> Cal Leak Expiration and Internal Calibrated Leak values (Section 3.1.8.3.1 on page 3-23) <input type="checkbox"/> Password (Section 3.1.8 on page 3-19) <input type="checkbox"/> Fore Pump and Diaphragm Pump (Section 3.1.10 on page 3-25). <input type="checkbox"/> Wireless (Section 3.1.11 “Wireless” on page 3-27). <input type="checkbox"/> System Defaults (Section 3.1.12 “System Defaults” on page 3-29).

1.6 Rear Panel

The rear panel of the leak detector with an external mechanical pump (Model VS MR15 or MD30) and a wireless remote control option is shown in Figure 1-8.

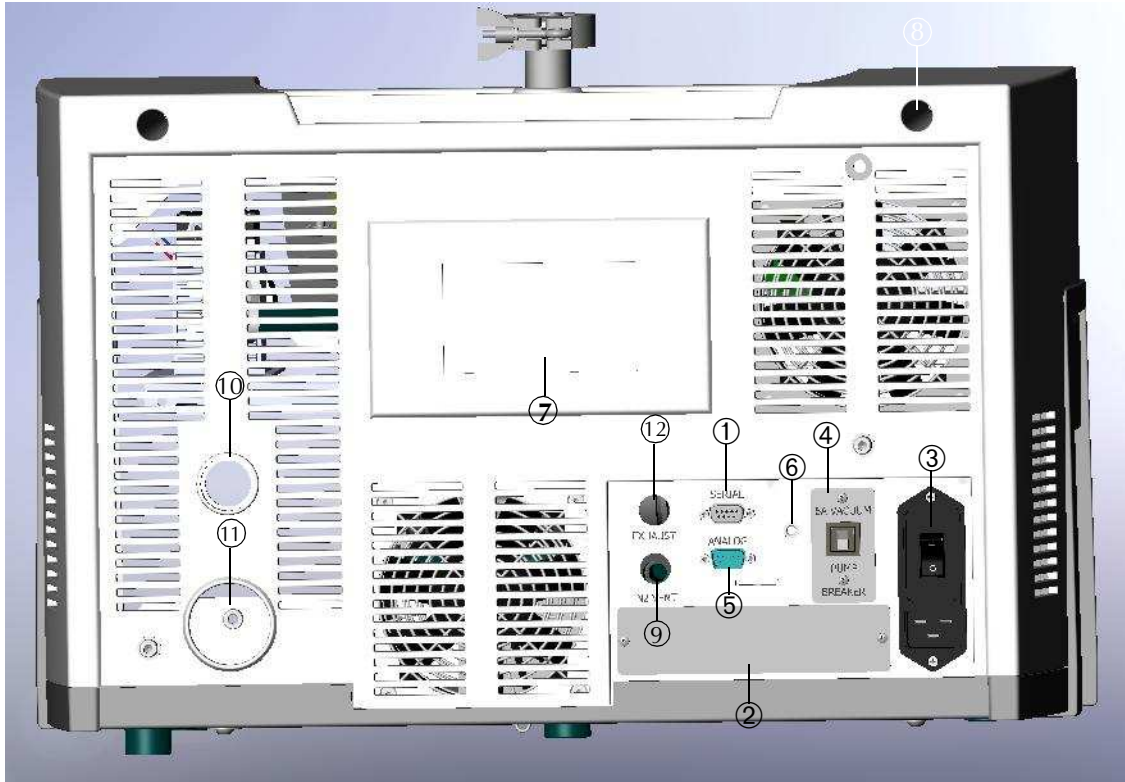

Figure 1-8 VS Series Rear Panel

- | | |
|----------------------|---|
| ① Serial Connector | <p>A 9-pin male D-type connector to interface with an external PC via RS-232 type communications protocol for system diagnostic or control.</p> <p>A detailed summary of information related to serial communication is provided in Section A “Communications Protocol” on page A-1.</p> |
| ② Cover Plate | <p>Access to expansion slot. This is not used when an optional I/O PCB is installed. A rear panel of the optional I/O PCB is shown in Figure 1-9 on page 1-19.</p> |
| ③ Power Entry Module | <p>Provides supply power, overcurrent and EMI protection for the leak detector. The Power Entry Module consists of:</p> <ul style="list-style-type: none"> ❑ Power Input Connector - An IEC/EN60320/C20 standard, three-prong grounded Inlet connector. ❑ Power Switch (I/O) - A 20A rocker type Power Switch/Thermal Circuit Breaker. ❑ 20 A EMC line filter. |

VS Series Helium Mass Spectrometer Leak Detectors

- | | |
|------------------------------|--|
| ④ Fore Pump Power Connection | An IEC/EN60320/C19 standard, three-prong grounded outlet connector. |
| ⑤ Analog Output | Banana type output connector for an Isolated Leak Rate Analog reading. The Red connector is a signal positive terminal; black is the signal negative terminal. Signal range: From 0 to +10 VDC.

Later models of the VS will be equipped with a DB9F connector for the analog output. Pin #1 is signal (positive) and Pin #2 is return (negative). |
| ⑥ Chassis (Earth) Terminal | Provided for additional connection of the leak detector to the building grounding system to improve ESD protection. |
| ⑦ Product Label | A product label with part number, serial number and rating information. |
| ⑧ RF Antenna | A 2.4 GHz antenna for the optional Wireless Remote Control. |
| ⑨ Exhaust Cover | Exhaust opening for a VS PR02 model. |
| ⑩ Oil Level Cover | Oil level window for a VS PR02 model. |
| ⑪ Oil Drain Cover | Oil drain opening for a VS PR02 model. |
| ⑫ Nitrogen Vent Port | Nitrogen vent port (On newer models). |
| Test Port | Test port adapter (not shown). |
| 2-Wheel Cart | 2-wheel cart for an external fore pump (not shown) |
| Wireless Label | A wireless info label for VS leak detector with an optional Wireless Remote Control. |

A rear panel for the optional I/O PCB assembly is shown in Figure 1-9.

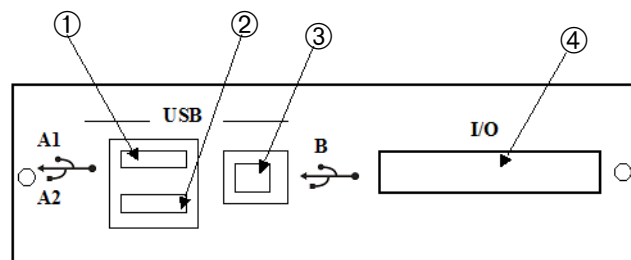

Figure 1-9 Optional I/O PCB Rear Panel

- | | |
|------------|--|
| ① USB - A1 | USB 1.1 full speed downstream port, USB type A receptacle. |
| ② USB - A2 | USB 1.1 full speed downstream port, USB type A receptacle. |
| ③ USB - B | USB 1.1 full speed upstream port, USB type B receptacle. |

VS Series Helium Mass Spectrometer Leak Detectors

④ I/O Connector A 25-pin female D-sub connector to interface with an external PLC via a parallel cable.

Inputs:

- ❑ Four level inputs: optically isolated, (+5 to+24) VDC.
- ❑ Four momentary inputs: optically isolated, (+5 to+24) VDC, requires 200 ms pulse width.

All inputs are opto-isolator LEDs with a series 3300 Ohm resistor.

Outputs:

- ❑ Eight optically isolated emitter followers with a 10 Ohm series resistor, 14 mA max drive current, +24VDC max.

Power:

- ❑ An external power supply is supplied by the user.

A detailed summary of information related to I/O pin identifications is provided in Table A-6 on page A-14.

VS Series Helium Mass Spectrometer Leak Detectors

The rear panel of the leak detector (Model VS PR02 and PD03) is shown in Figure 1-10. The optional Wireless remote control and I/O PCB is not installed.

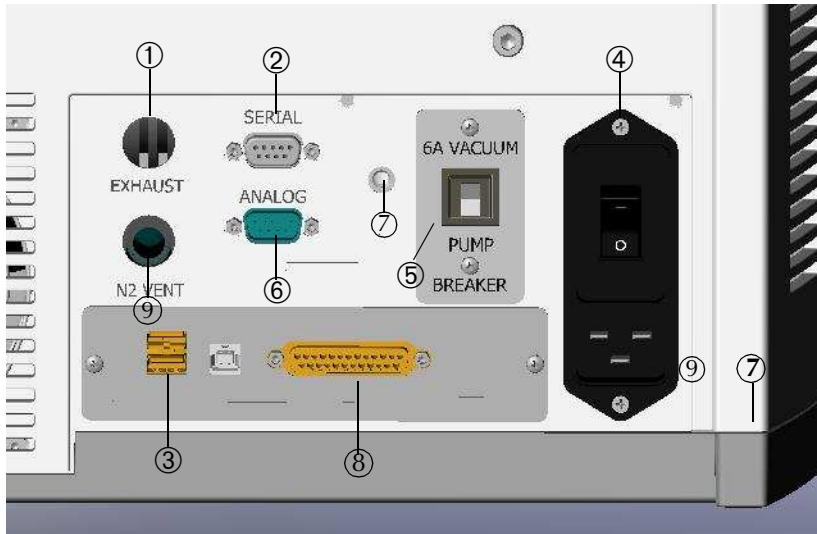

Figure 1-10 Rear Panel (with Discrete I/O PCB)

- | | |
|-----------------------|--|
| Oil Drain | For the internal mechanical vacuum pump (PR02 only, not shown). |
| Glass Window | Oil level sight glass reading (PR02 only, not shown). |
| ① Exhaust | A barbed hose fitting (OD = 12.57 mm) for exhaust of the internal mechanical vacuum pump. |
| ② Serial Connector | A 9-pin male D-type connector to interface with an external PC via RS-232 type communications protocol for system diagnostic or control

A detailed summary of information related to serial communication is provided in Section A “Communications Protocol” on page A-1. |
| ③ USB | Standard USB connector (types USB A and USB B). |
| ④ Power Entry Module | Provides supply power, overcurrent and EMI protection for the leak detector. The Power Entry Module consists of: <ul style="list-style-type: none"> ❑ Power Input Connector - An IEC/EN60320/C20 standard, three-prong grounded inlet connector. ❑ Power Switch (I/O) - A 20A rocker type Power Switch/Thermal Circuit Breaker. ❑ 20 A EMC line filter. |
| ⑤ Vacuum Pump Breaker | A 6 A Thermal Circuit Breaker for the internal mechanical pump. |

VS Series Helium Mass Spectrometer Leak Detectors

- ⑥ Analog Output Banana type output connector for an Isolated Leak Rate Analog reading. The Red connector is a signal positive terminal; black is the signal negative terminal. Signal range: From 0 to +10 VDC.

Later models of the VS will be equipped with a DB9F connector for the analog output. Pin #1 is signal (positive) and Pin #2 is return (negative).
- ⑦ Chassis (Earth) Terminal Provided for additional connection of the leak detector to the building grounding system to improve ESD protection.
- ⑧ 25 Pin I/O
 - ❑ Inputs: Opto-isolated, 5 - 24 VDC 3300 Ohm resistive load. All inputs are opto-isolator LEDs with series resistors.
 - ❑ Momentary Inputs: Opto-isolated, 5 - 24 VDC 3300 Ohm resistive load, requires 200 ms minimum pulse width.
 - ❑ Outputs: Emitter follower with 10 Ohm series resistor, 14 mA max drive current, 24 VDC max.
For pin identifications, see Table A-6 on page A-14.
- ⑨ Nitrogen Vent Port Nitrogen vent port (On newer models).

1.7 Features

The features for the VS Series leak detector are provided in Table 1-4.

Table 1-4 VS Series Features

Feature	Description
Calibration	Fully automated tuning and calibration using the internal or external calibrated leak. The fast calibrate feature allows calibration in less than one minute.
Zero Control	Selectable mode background elimination with a unique, patented Autozero<0 feature.
Leak Indication	A bar graph (linear or log) indicator displays leak rates automatically; alphanumeric indication on LCD display. A leak can also trigger an audible alarm frequency that varies in proportion to the size of the leak, dedicated volume control and programmable audio threshold. Analog voltage is proportional to the leak rate.

VS Series Helium Mass Spectrometer Leak Detectors

Table 1-4 VS Series Features (Continued)

Feature	Description
Pressure Indication	Test port and spectrometer pressure with alphanumeric indication on the LCD display.
Spectrometer	Sensitivity optimized design, header mounted ion source with dual thoria-coated iridium filament, a high sensitivity, wide dynamic range preamplifier, and vacuum gauge.
Automatic Valve Sequencing	Microprocessor-controlled valve operation provides automatic system cycling.
Safety Interlocks	A valve system design that completely protects the high vacuum system under test against pressure surge and power interruption.
Optional	
Wireless Remote Control	<p>This provides:</p> <ul style="list-style-type: none"> <input type="checkbox"/> RF communication between the VS leak detector (with base station or host) and the Wireless Remote unit from a distance up to 100 m (300 ft). <input type="checkbox"/> The ability to enter the VS leak detector unit into Test and Hold modes from the Wireless Remote unit's keypad. <input type="checkbox"/> The ability to read the VS leak detector's leak rate in a linear and logarithmic bar graph format with a numeric range indicator and System status in alphanumeric format on the Wireless Remote unit's LCD display. <input type="checkbox"/> Configuration up to 10 different VS leak detector unit's for wireless control by toggling through a MAC address list using one Wireless Remote unit
Discrete I/O Control	This provides 12 outputs and 8 inputs lines, optically isolated, to control the VS leak detector using an external PLC via a 25-pin DB25 female connector and a user-provided parallel cable.

This page intentionally left blank.

Section 2. Operating the Leak Detector

2.1 Initial Startup, High Pressure Test Setup, and Shutdown

2.1.1 Startup

To start the leak detector:

1. Plug the leak detector power cord into an appropriate mains supply receptacle.
2. Move the power switch on the rear power control panel to the **I** position. If you have a bench system with a separate backing/roughing pump, turn the pump on. The Vent and Test buttons are disabled on start up until *System Ready* appears on the Home screen.

The *System Ready* indication appears on the Home screen. If the leak detector is being started after a long period of being off (several hours), it can take up to three and a half minutes to stabilize and provide reliable, quantitative leak rate readings.

The leak detector is capable of performing an automated calibration routine using either an internal calibrated leak (factory installed), or an external calibrated leak placed into the system test port. Refer to Section 2.2.4.1 “Calibration Set-Up” on page 2-16 to properly set-up the leak detector for auto-calibration.



If the system was recently calibrated before shut down, it can be used for qualitative testing. Read the standard leak to verify accuracy. For more accurate quantitative leak values, perform a calibration 30 minutes after start-up.

To accurately read in the most sensitive decades (E-10 and E-11), warm up the leak detector for at least one hour prior to performing a full calibration. When leak checking in the E-9 atm-cc/sec range or higher, you can use the leak detector prior to one hour and verify system performance by assuring that the system can accurately read the internal calibrated leak.

The system is shipped from Varian with the Range Stop function turned ON and the bottom range set at the E-10 range (atm-cc/sec). To accurately test in the E-11 range, careful control of materials and the environment is required, consult a Varian sales engineer for support.

3. Execute a calibration routine:
 - Internal calibrated leak:
 - a. Press **Test** on the front panel to place the system in test mode.
 - b. Press **Control Panel** on the Home screen.
The Control Panel appears.
 - c. Press **Calibrate**.
The system performs an automated calibration of the system.

VS Series Helium Mass Spectrometer Leak Detectors

- ❑ External leak:
 - a. Press **VENT** to vent the leak detector and then install a calibrated leak into the system test port.
 - b. Open the Calibration Set-Up screen and press **External Leak** (located under Calibrate With).
 - c. Press **Done**.
 - d. Press **Test** to place the leak detector into Fine Test mode.
 - e. Press **Control Panel** on the Home screen.
The Control Panel appears.
 - f. Press **Calibrate** to perform an automated calibration.

For calibration in the E-10 range, the vacuum system must be sufficiently pumped to reduce helium background below the E-10 range signal level. This is required to achieve an acceptable signal-to-noise level and ensure accurate calibration.

E-10 range calibration is performed using an external calibrated leak. If an external calibration is selected soon after system startup, the VS system evaluates the helium background and determines if the background signal is sufficiently low to give an accurate calibration. If the:

- ❑ System has pumped out sufficiently, the calibration proceeds.
- ❑ Background is changing, indicating the system is still pumping away background helium, a countdown timer appears (Figure 2-1). The VS system monitors the helium background and shows the time until the calibration begins. Should you prefer not to wait, a *Cancel* button permits the calibration request to be cancelled.

NOTE



The firmware initially starts at a large time interval, but recalculates the required time as the pumping continues. The new time is reflected on the timer.

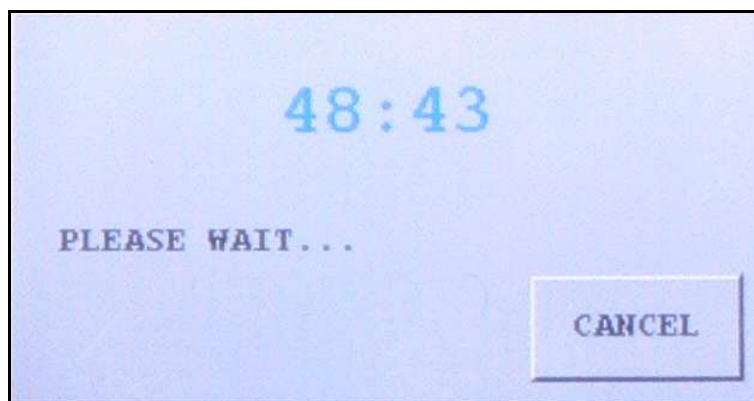

Figure 2-1 Helium Background Timer



When calibration is complete, the leak detector reverts to Fine Test mode.

2.1.2 High Pressure Test Set-Up Procedure

The High Pressure Test mode locks the system into contraflow, offering maximum protection to the spectrometer. This is useful in sniffing applications or when evacuating parts that can contaminate the system.

To configure the High Pressure Test (optional):

1. Open the Leak Rate Ranging screen (Section 2.2.4.4 “Leak Rate Ranging” on page 2-24) and turn the High Pressure Test feature ON.
2. If sniffing, vent the leak detector and attach a Varian Power Probe (Part Number K9565306) to the test port.
3. Monitor the test port pressure reading on the display and adjust the power probe flow valve for a test port pressure of 0.5 to 1 Torr (2 Torr maximum). This pressure setting allows for very rapid system response.
4. Press **Zero** on the Home screen to suppress the helium background signal.

High Pressure Test mode sensitivity is 10^{-4} to 10^{-8} atm cc/sec at test port pressures between 1 and 2 Torr using the power probe.

When High Pressure Test is activated, range stop defaults to 10^{-7} atm cc/sec.

2.1.2.1 Additional Sniffer Mode Setups

The following are highly recommended:

- In the Advanced Parameters menu (Section 3.1.1 “Advanced Parameters” on page 3-3) set the Auto-Zero < 0 to Inactive.
- Block Probe Alarm:
 - Activate the speaker and adjust the volume in the Control Panel screen.
 - Go to the Section 2.2.4.2 “Reject and Audio Set Points” on page 2-18 and activate the Audio Set Point. Program a pressure that is, ex. 20%, less than the adjusted pressure of the power probe for sniffing.
If the pressure falls below the programmed Audio Set Point, a steady state alarm tone is activated. This is extremely helpful in sniffing applications where the probe could become blocked, thus missing potential leaks.

High Pressure Test mode sensitivity is 10^{-4} to 10^{-8} atm cc/sec at test port pressures between 500mTorr and 2 Torr using the power probe. When High Pressure Test is activated, range stop defaults to 10^{-7} atm cc/sec, but selecting between 10^{-4} to 10^{-8} atm cc/sec is permitted.

2.1.3 Shutdown

The system can be in any mode when shut down. When the system is shut down, all valves in the system close. If the system is not in Vent mode, the test port remains under vacuum and may be difficult to open.

To shut down the leak detector:

- Move the power switch on the rear panel to the ○ position.







2.2 Screens

The leak detector display is used for the initial set-up and configuration of the leak detector. Once the leak detector is set up and configured for a specific application, basic operation is controlled primarily using the **TEST** and **VENT** buttons on the leak detector and the Home screen Zero button (Section 2.2.2 “Home Screen” on page 2-7).

2.2.1 Basic Functions

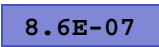
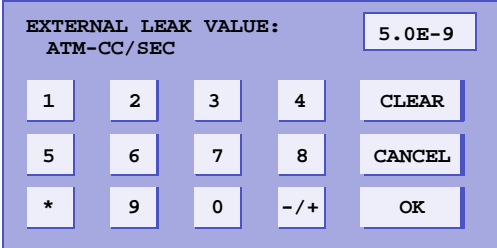
Table 2-1 explains the basic on-screen functions used to enter or manipulate values.









Table 2-1 Screen Basic Functional Items

Item	Function
	Using the Calibrate button as an example, LEDs light when the button is selected and activated.
	Press Done to exit a screen.
	Using a leak value as an example, press the value button and a keypad appears for entering values.
	<p>Using External Leak Value as an example, these keypads appear wherever values are entered. Enter the values with the keypad and press OK.</p> <p>The keypad values are dictated by the data required on the parent screen. For example, if entering a leak rate value, the system places an <i>E</i> or - sign in for the exponent.</p> <p>Press:</p> <ul style="list-style-type: none"> <input type="checkbox"/> Clear to clear the display. <input type="checkbox"/> Cancel to close the keypad screen without saving. <input type="checkbox"/> OK to close the keypad and save.
	Appears on screens more than one level from the Home screen. Press this button to return directly to the Home screen.
	Used to increment/decrement values.
	Saves all values on the screen and exits to the next higher screen.
	Moves you between menu selection screens when there is more than one screen of choices.

VS Series Helium Mass Spectrometer Leak Detectors

Table 2-2 explains the icons that appear on various screens and their meaning.

Table 2-2 On-Screen Icons

Icon	Meaning
	Indicates a feature is locked and cannot be activated due to a higher level selection in the VS setup.
	Indicates the status of the internal calibrated leak: If flashing, the leak calibration will expire within 10 days. Steady and blue indicates that the leak has expired. Steady and red indicates a temperature sensor failure or a disconnected cable to the calibrated leak temperature sensor.
	Indicates a turbo pump fault.
	Indicates that a valve is open.
	Indicates the leak detector is in split flow.
	Indicates there is a valve fault.
	Indicates that a valve is closed.
	Indicates that the split flow leak rate being entered is greater than 1000 times the indicated leak rate; the maximum permitted.
	Indicates that the unit is in communication with a wireless remote unit.

VS Series Helium Mass Spectrometer Leak Detectors

2.2.2 Home Screen

The Home screen displays a summary of the following status and configuration settings:

- Digital Leak Rate Display
- Test Port Pressure
- Gross Test button (not shown)
- Leak Detector Status (Table 2-3 on page 2-9)
- Condition Indication (Table 2-4 on page 2-10)
- Reject Status Indicator
- System Ready Indicator (not shown)
- Control Panel button
- Menu button

Two soft key buttons, Control Panel and Menu, give access for changing the leak detector configuration (Figure 2-2).

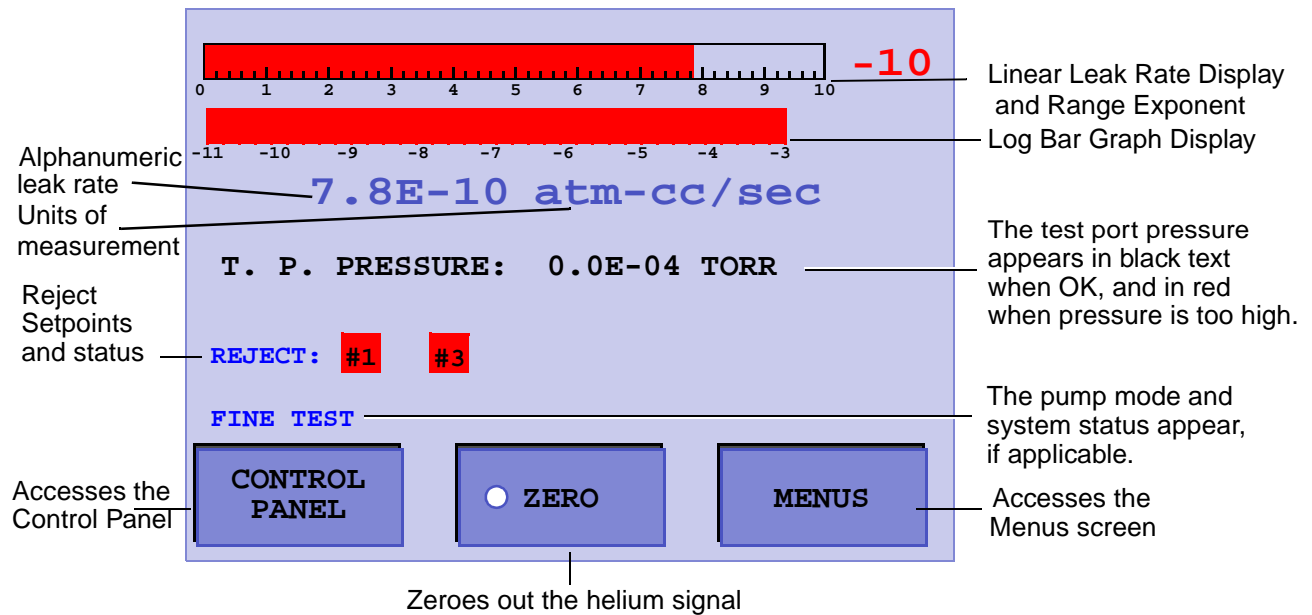



Figure 2-2 Home Screen

- Digital Leak Rate** Correlates (Figure 2-2) directly with the log bar graph leak rate display. The units for the measurements are selected on the Units Set-Up screen (see Section 3.1.5 “Units” on page 3-15).
- Test Port Pressure** Appears on the Home screen and represents the test port pressure as measured by a thermocouple device mounted on the valve block just below the test port. The pressure transducer and associated electronics are intended to protect the leak detector from damage due to over-pressure conditions. Use an external pressure transducer if the test process requires a more accurate monitoring of the test object pressure.

VS Series Helium Mass Spectrometer Leak Detectors

Leak Detector Status	Appears below the test port pressure reading and indicates the current leak detector operating state. The normal operating states are detailed in Table 2-3 on page 2-9.
Leak Detector Condition	Appears below the Leak Detector Status and indicates the current leak detector condition during abnormal conditions. See Table 2-4 on page 2-10 for a list of leak detector conditions.
Reject Status Indicator	Appears below the Leak Detector Condition on the left-hand center of the Home screen when any of the four independent set points are enabled and activated (Section 2.2.4.2 on page 2-18).
Control Panel	When pressed, opens the Control Panel screen (Section 2.2.3 “Control Panel Screen” on page 2-12).
Zero	<p>Zeroes out the helium leak indicated on the display. The Zero LED lights while zeroing is taking place. The leak rate must be less than $4.0E-7$, while in Test, to allow a cross over to Fine Test.</p> <p>The Zero button is only active while the leak detector is in the test state and causes the leak detector to reset the leak rate display.</p> <p>The leak detector automatically subtracts the recorded background signal to display only the real leak rate.</p>
	<p>NOTE</p> <p> <i>Pressing Zero while introducing helium tracer gas to the test object or while the helium background is varying significantly could result in the suppression of a real leak. Only use the Zero button after the helium tracer gas source has been removed.</i></p> <p>The Zero capability allows the testing of sensitivity levels that are below the system background. This feature also reduces test cycle times by reducing the amount of time required for background levels to naturally clean up or by allowing testing to begin at relatively high test pressures. It is recommended that only two decades of signal be zeroed out.</p>
Menus	Displays the Menus screen (Section 2.2.4 on page 2-15).

VS Series Helium Mass Spectrometer Leak Detectors

Gross Test Displays Gross Test screen (Figure 2-3).

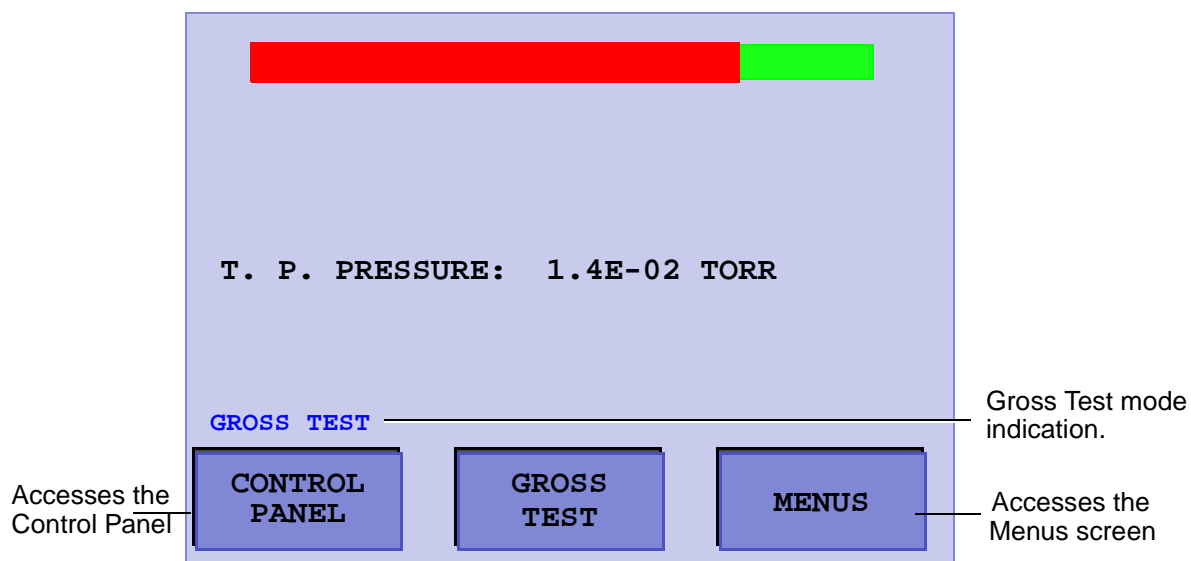

Figure 2-3 Gross Test Screen

Table 2-3 Leak Detector Operating States

Display	Description
Calibrating	Indicates that the leak detector is currently performing a calibration routine.
Test	Indicates that the leak detector is in Test mode. When in Test mode, the Test Port valve opens and the leak detector is ready for leak testing. Test leak rate range is 1E-4 to 1E-8 (MDL 5E-9).
Fine Test	Indicates that the leak detector is in Fine Test mode. When in Fine Test mode, the test port valve opens and the leak detector is ready for fine leak testing. Fine Test leak rate range is 9E-7 to 1E-11 (MDL 5E-12).
Hold	Indicates that the leak detector is in Hold mode. When in Hold mode, all but the foreline valves are closed, isolating the test port and any test objects or fixturing from the leak detector vacuum system. Use Hold when you want to keep the test port under vacuum without venting the test volume; this helps the system clean up.
Roughing	Indicates that the leak detector is currently performing a Roughing level evacuation of the test port and any attached test objects or fixturing attached to the test port.
Std Leak	Indicates that the optional internal calibrated leak standard valve is open and that the leak detector is reading the leak value.
Vented	Indicates that the test port is vented to atmosphere. The test port and all objects attached to the test port are isolated from the leak detector internal vacuum system.

VS Series Helium Mass Spectrometer Leak Detectors

Table 2-4 Leak Detector Condition States

Display	Description
Backing	Indicates that the leak detector is momentarily backing the foreline of the high vacuum pump during an extended rough period. Backing occurs if the roughing time is greater than 60 minutes or if the turbo pump is not ready.
Both Filaments Burned Out/ No Emission	Indicates that no filament emission is detected. This can result from a PCB or cable problem, or burned out filaments.
Cal OK	Indicates that the calibration routine was executed successfully.
Calibration Prep	Indicates that the leak detector is preparing for a calibration routine.
Filament 1 Burnt Out	Indicates that filament 1 of the ion source has burnt out. Filament 2 automatically lights if it is still good, and a flashing C appears in the leak rate exponent, indicating that a calibration routine is required.
Filament 2 Burnt Out	Indicates that filament 2 of the ion source has burnt out. Filament 1 automatically lights if it is still good, and a flashing C appears in the leak rate exponent, indicating that a calibration routine is required.
Filament Wait	Indicates that the system is lighting the filament.
Flashing C On Exponent Display	Indicates that the leak detector requires calibration.
Gain Too High	Indicates that the gain value required to calibrate the leak detector during the calibration routine is greater than the maximum allowable value. This is generally the result of system sensitivity being too low, due to normal system aging.
Gain Too Low	Indicates that the gain value required to calibrate the leak detector during the calibration routine is less than the minimum allowable value. This is generally the result of a system leak.
High Background	Indicates a high Helium background detected during calibration self-test. This typically, indicates a VS vacuum system leak.
No Ion Peak	Indicates a tuning/calibration failure due to the system not detecting an ion peak during the auto-tuning routine.
Offset Fault	Indicates an electronics failure identified during calibration self-test.
Offset Wait	Indicates that the system is setting the Offset value.
Reject	Indicates a test object failure during an Auto Sequencer Test cycle. See Section 2.2.4.3 "Auto Sequencer" on page 2-21.
Spec-Tube	Flashes red when the spectrometer pressure > 1.0E-4 Torr.

VS Series Helium Mass Spectrometer Leak Detectors

Table 2-4 Leak Detector Condition States (Continued)

Display	Description
Stabilization Wait	Indicates that the system is waiting for the electronics to stabilize before completing the startup routine; up to two and a half minutes.
Std Leak Prep	Indicates that the optional internal calibrated leak is being roughed before it is introduced directly to the system for calibration verification.
Switching Filaments	Indicates that the system is momentarily in the process of switching from a burnt out filament to the next available filament.
System Pressure Wait	Indicates that the system (spectrometer) pressure is too high to light the ion source filament.
System Ready	Indicates that the system is ready for testing. This message appears only during the initial startup and is cleared after the first test cycle.
Zeroing	Indicates that the leak detector is in the process of Zeroing out a background signal. The Zero routine is initiated automatically during the startup and calibration routines, or manually when the operator presses the Zero button on the Home screen.
Zeroing Wait	Indicates that the system is setting the initial zero values during the startup routine.

2.2.3 Control Panel Screen

- Press **Control Panel** on the Home screen. The Control Panel screen appears (Figure 2-4).

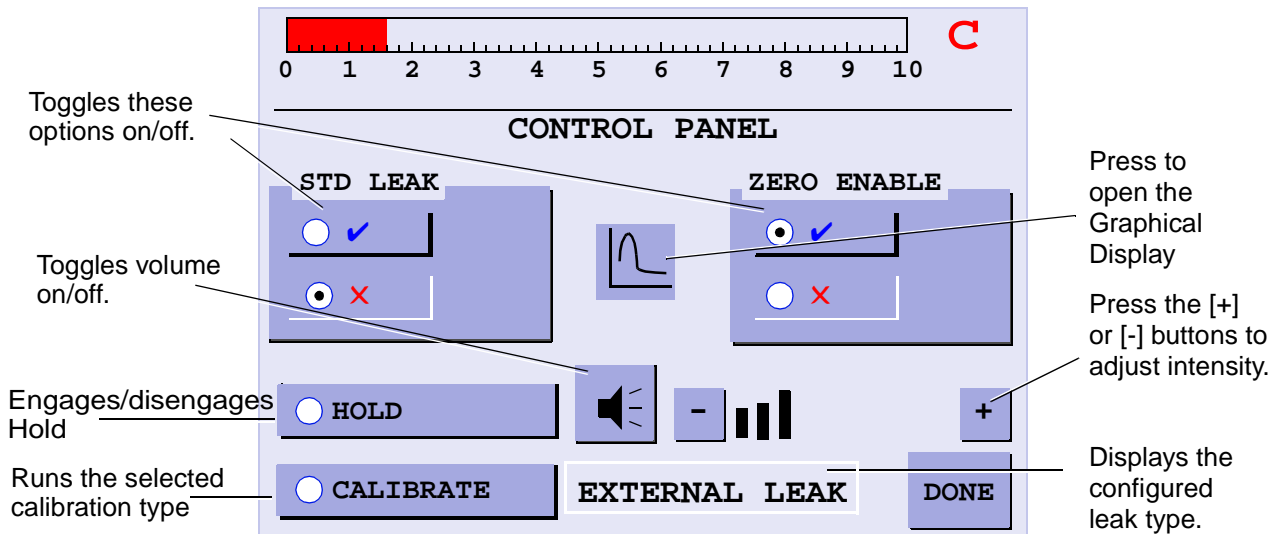

Figure 2-4 Control Panel

Std Leak

Opens the standard leak valve so the leak can be seen by the system.

The Std Leak button is only functional while the leak detector is in fine test and activates the internal calibrated leak, allowing verification of the system calibration. When the system is in Std Leak mode, Std Leak appears on the Home screen.

The Std Leak button isolates the test port from the system and exposes the leak to the spectrometer. This allows you to compare the *displayed* leak rate value to the *calibrated* leak value on the System Information screen to verify proper system operation.

Because the test port is isolated from the fore pump in this mode, a slight increase in test port pressure may be indicated on the test port pressure display.

Zero Enable

Turns on or off the zeroed out background. This feature excludes the background leak from the leak rate signal.

Helium background represents helium that is in the system but does not come from the part under test. If the background is zeroed out, a more accurate measurement of the leak rate of the part is determined. If Zero Enable is turned ON, the background is excluded; if it is turned OFF, the system displays the full helium signal, including total background.

VS Series Helium Mass Spectrometer Leak Detectors

Audio Volume	<p>Adjusts the volume up and down by pressing on the +/- buttons:</p> <ul style="list-style-type: none"><input type="checkbox"/> When the leak rate bar graph display is set to Linear mode:<ul style="list-style-type: none"><input type="checkbox"/> The audio signal increases from a low to high frequency as the leak rate increases within each decade.<input type="checkbox"/> The pitch cycles low to high as it passes through each decade. The audio response corresponds directly to the size of the leak.<input type="checkbox"/> To turn the sound on/off, press the speaker button. The volume level is restored to the level it was at prior to being turned off.
Hold	<p>Places the system in Hold; keeps the test port under vacuum and does not vent. Use Hold to keep the system under vacuum, while taking the leak detector out of test. This is useful if you want to let the leak detector clean up the helium background, while keeping the system under vacuum.</p> <p>Press Hold while the leak detector is in the test state and the unit advances to the Hold state. When in Hold mode, the test port is isolated from the leak detector vacuum system. Since the test port pressure gauge is located on the test port side of the isolation valve, a subsequent rise in test pressure can be observed while in this mode.</p>
Calibrate	<p>Calibrates the system. <i>Internal</i> or <i>External</i> appears to indicate which leak the system is using to calibrate.</p> <p>Automated calibration is performed based on the parameters set on the Calibration Set-Up screen (Section 2.2.4.1 "Calibration Set-Up" on page 2-16). The Calibrate LED lights while calibration is taking place.</p> <p>The sequence of events is:</p> <ul style="list-style-type: none"><input type="checkbox"/> The leak detector exposes the internal standard leak to the system or verifies that the test port is roughed out and exposes the external leak to the system.<input type="checkbox"/> The ion voltage is scanned to find the peak signal.<input type="checkbox"/> The system notes the leak rate reading, turns the leak off and zeroes the system.<input type="checkbox"/> A gain is calculated from the leak rate reading to make the signal match the value of the calibrated leak and returns the system to Test mode.

VS Series Helium Mass Spectrometer Leak Detectors

2.2.3.1 Graphical Display Screen

The graphical display screen (Figure 2-5) represents the leak rate over time. The graphing line appears in blue and changes to red when a reject set point is triggered.

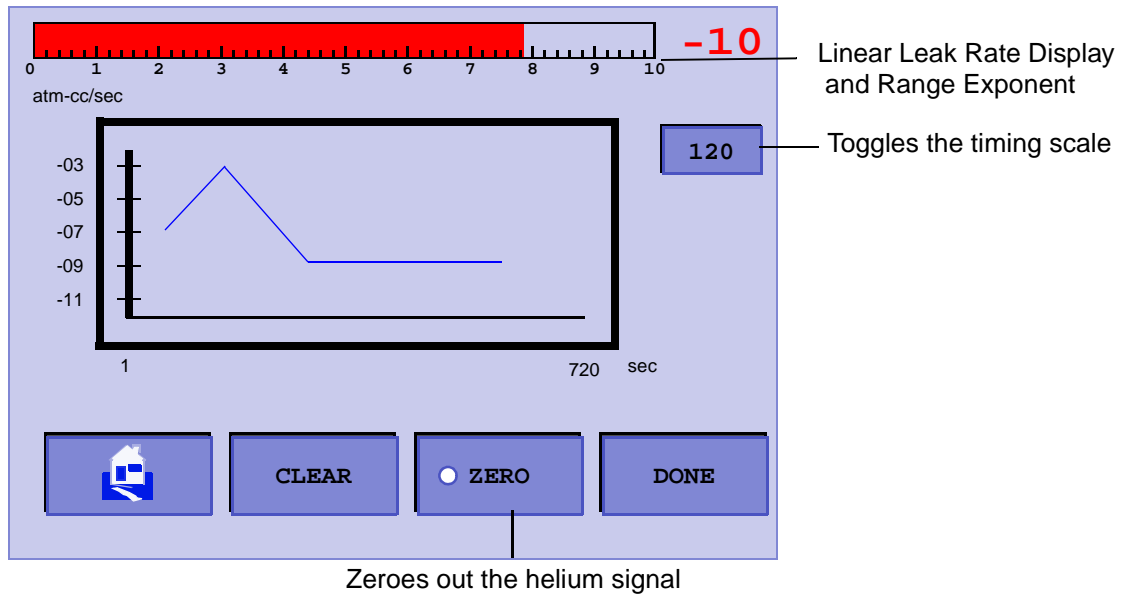

Figure 2-5 Graphical Display

Timer	Toggles the graphing time between 120 and 720 seconds. The timer automatically defaults to 120 seconds on leak detector start up. Press the toggle button while graphing to clear the current graph. The data rate for the timers are: 120 seconds - two measurements/second 720 seconds - one measurement/three seconds.
Clear	Clears the plotted graph. The graph automatically clears when the leak detector is in roughing mode or at the start of a new test.
Zero	Zeroes out the displayed helium leak. The leak rate must be less than $4.0E-7$, while in Test, to allow a cross over to Fine Test. This button causes the leak detector to reset the leak rate display, while the graph tracks the effect of the Zero command.

NOTE



Pressing Zero while introducing helium tracer gas to the test object, or while the helium background is varying significantly, could result in the suppression of a real leak. Only use the Zero button after the helium tracer gas source has been removed.

The Zero capability allows the testing of sensitivity levels that are below the system background. This feature also reduces test cycle times by reducing the amount of time required for background levels to naturally clean up or by allowing testing to begin at relatively high test pressures. It is recommended to zero out only two decades of signal.

2.2.4 Menu Screen

- Press **Menus** on the Home screen. The Menu screen appears (Figure 2-6). Use the arrow to navigate to the previous screen.

The Menu screen consists of buttons to access the lower level screens used for application-specific configuration.

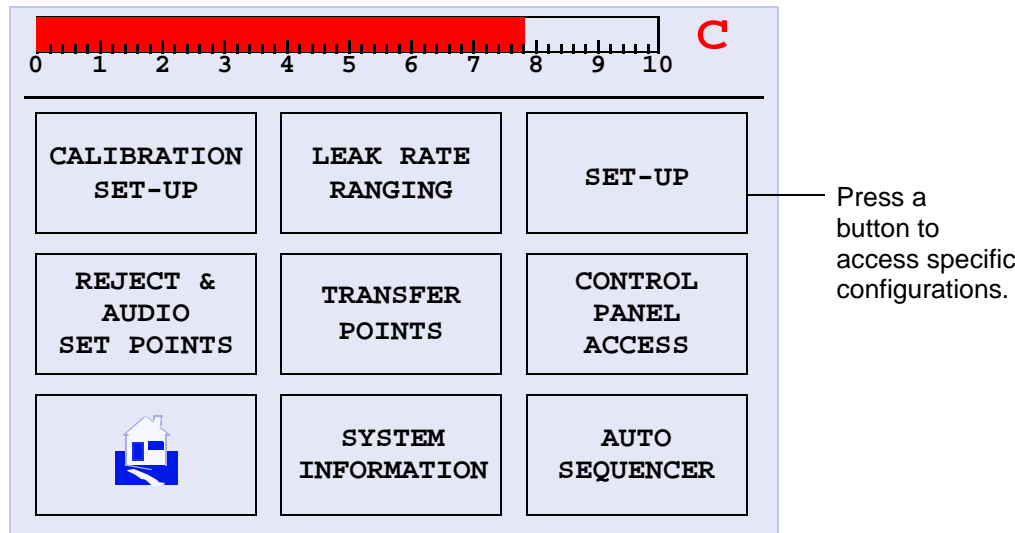

Figure 2-6 Menu Screen

2.2.4.1 Calibration Set-Up

- Press **Calibration Leak Set-Up** on the Menu screen.

The Calibration Set-Up screen appears (Figure 2-7).

Use this screen to:

- View the value and expiration date of the Internal Calibrated Leak
- Enter the External Calibrated leak value
- Select whether to use an Internal or external calibrated leak
- Set the calibration mode: Full or Fast Calibration

The calibration routine can be executed without removing the test object or test fixture from the test port.

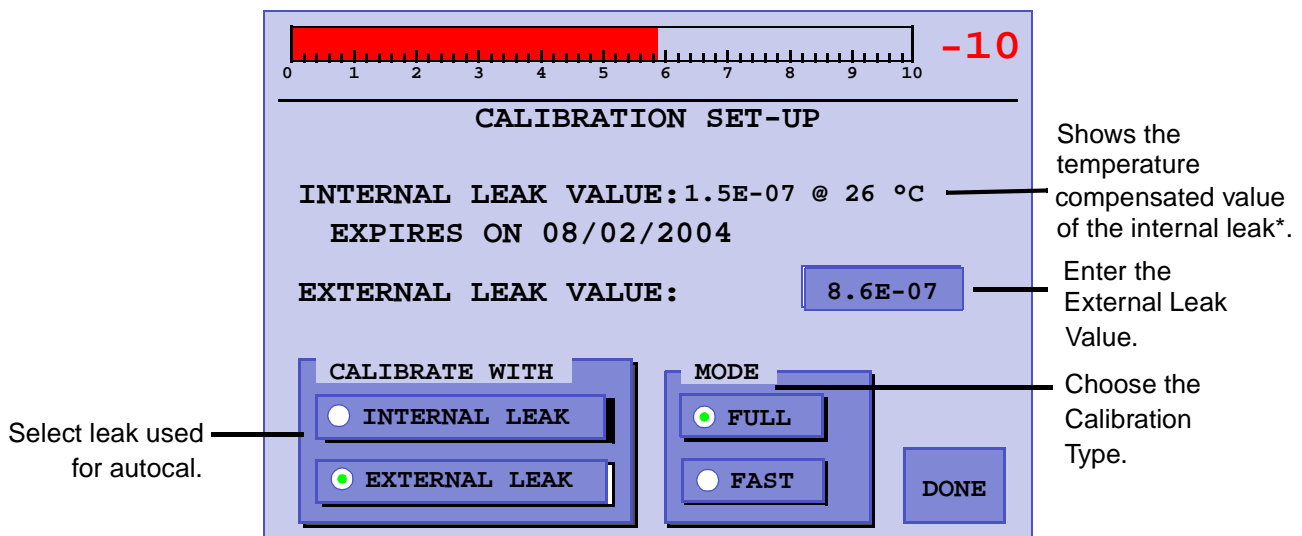

Figure 2-7 Calibration Set-Up

- | | |
|------------------|--|
| Full Calibration | Performs a thorough tuning process and a system gain adjustment (calibration). The full tuning process involves scanning the ion source chamber voltage, and optimizing each value for a maximum helium signal. Once the tuning process is complete, system gain is adjusted to bring the leak detector into calibration. A full calibration takes less than three minutes. |
| Fast Calibration | Compares the leak rate signal with the calibrated leak value and adjusts the gain to bring the system into calibration. If the gain value is above the upper gain limit for the working range as defined in Section 2.2.4.4 "Leak Rate Ranging" on page 2-24, then the fast calibration process is terminated and a flashing c symbol appears on the Home screen. A fast calibration takes less than 30 seconds. |

* If the system cannot read the internal calibrated leak temperature, the system displays the leak value and the temperature shown on the calibrated leak label. If this happens, the calibrated leak symbol on the main screen turns red.

VS Series Helium Mass Spectrometer Leak Detectors

- Internal Leak Value The temperature-compensated internal leak value and expiration date appear to the right of the Internal Leak Value text. The actual Internal Leak Value and Expiration Date can be modified using the Internal Calibration Leak screen (Section 3.1.8.3.1 “Cal Leak Expiration Set-Up” on page 3-23).
- External Leak Value Displays the value on an operational button.

To configure an external leak:

1. Press **External Leak** (located under Calibrate With).
2. Press the button to the right of the External Leak Value text.
The data entry pad appears.
3. Enter the leak value and press **OK**.

For calibration in the E-10 range, the vacuum system must be sufficiently pumped to reduce helium background below the E-10 range signal level. This is required to achieve an acceptable signal-to-noise level and ensure accurate calibration.

E-10 range calibration is performed using an external calibrated leak. If an external calibration is selected soon after system startup, the VS system evaluates the helium background and determines if the background signal is sufficiently low to give an accurate calibration. If the:

- System has pumped out sufficiently, the calibration proceeds.
- Background is changing, indicating the system is still pumping away background helium, a countdown timer appears (Figure 2-8). The VS system monitors the helium background and shows the time until the calibration begins. Should you prefer not to wait, a *Cancel* button permits the calibration request to be cancelled.



The firmware initially starts at a large time interval, but recalculates the required time as the pumping continues. The new time is reflected on the timer.

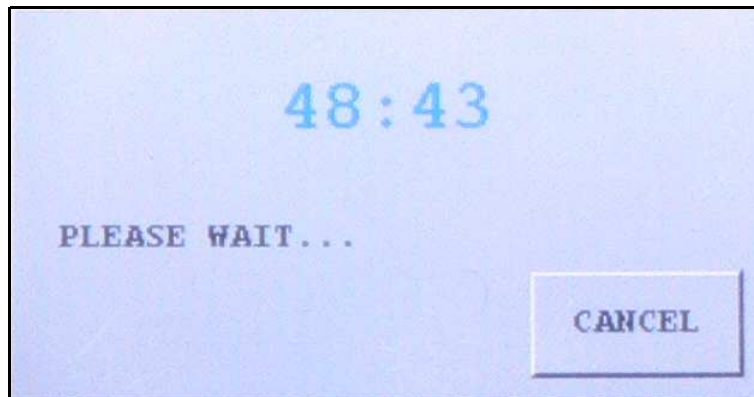

Figure 2-8 Helium Background Timer

2.2.4.2 Reject and Audio Set Points

Reject and Audio Set Points make the acceptance and rejection of parts more obvious. By creating a set point, you let the system indicate if the part meets specification or not. For example, you select LEAK RATE #1, set the value to 1.0E-8, set the reject activation to *greater than* > (activate when the leak rate is above that set point), and turn the set point ON. Then when the system is put into TEST, it indicates on the front panel that the part has not meet the set point requirement, until it gets below the set point value and then the set point failure indication disappears.

Multiple set points are used when you want to indicate several levels of acceptance. There are times when you may want to assure the leak detector is working properly by bounding the failure limit. For example, if LEAK RATE #1 were set as per above, then any leak rate below 1.0E-8 would pass the part. Also assume that the leak detector was not seeing helium, it would always pass parts. One way of preventing this from happening is to periodically read the internal calibrated leak. Another way is to place a 5.0E-10 range leak into the test port along with the part and program a second reject set point to fail if the leak detector were to go below that value. In that case, you would program LEAK RATE #2 to 4.7E-10, set the reject activation to *less than* < (activate when the leak rate is below that set point), and turn the set point ON. In this case, when the system is put into TEST, the system indicates a failure if the leak rate goes below 5.0E-10.

- ❑ Press **Reject & Audio Set Points** on the Menu screen.

The Reject and Audio Set Points screen appears (Figure 2-9).

Use this screen to:

- ❑ Set the parameters to enable or disable.
- ❑ Display or change the value of the four reject set points and the audio set point.

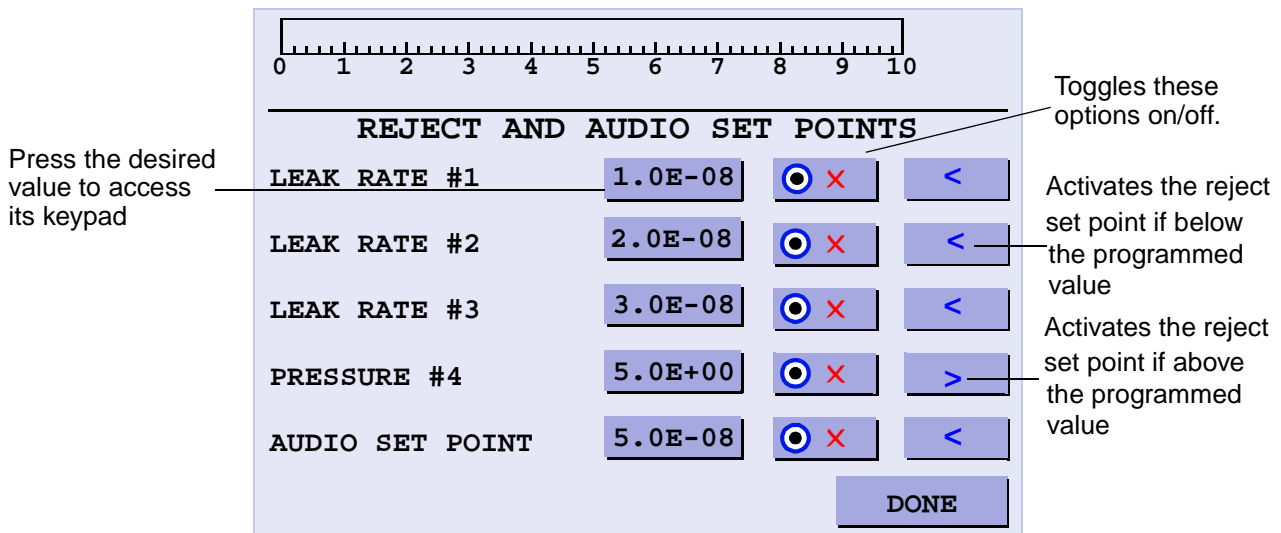

Figure 2-9 Reject and Audio Setpoints

Reject Set Points

Active reject set points cause *Reject* to appear on the Home screen along with the number of the reject set point that has been activated, which blinks to highlight the reject. The status of the reject set points are also available through the RS-232 line (see Appendix A “Communications Protocol”). Individual reject set points can be disabled using the blue check/red X buttons located to the right of each set point field.

There are four possible reject set points. Three reject set points can be programmed to a leak rate value and one can be programmed to test port pressure.

Set points may be turned ON or OFF (enabled or disabled) for each set point. If a Reject Set Point is ON, then the rear panel output for that set point goes active when its leak rate value is exceeded and a reject indication appears on the Home screen.

Each reject set point is set to activate above or below the programmed value. To activate the reject set point:

- Above the programmed value, select the >.
- Below the programmed value, select the <.

Audio Set Point

Settings:

- On:
The audio tone rate increases proportionally with each decade that the measured leak increases above the set point (leak rate pass/fail specification). The audio volume control is located on the Control Panel (see Section 2.2.3 “Control Panel Screen” on page 2-12).

NOTE



For Blocked Probe Alarm - High Pressure Test (Sniffing Mode) see Section 2.1.2 “High Pressure Test Set-Up Procedure” on page 2-3.

- Off:
The audio sounds for all leak rates above zero (see Section 2.2.4.4 “Leak Rate Ranging” on page 2-24).

Set points may be turned ON or OFF (enabled or disabled). When the Audio Set Point is OFF, audio sounds for all leak rates above zero (see Section 2.2.4.4 “Leak Rate Ranging” on page 2-24). When the audio set point is ON, audio sounds only for leak rates above the audio set point.

To configure reject set points and the audio set point:

1. Press the blue check for the Reject Set Point.
2. Press the value button associated with the set point.

VS Series Helium Mass Spectrometer Leak Detectors

The data entry pad appears.

3. Enter the set point and press **OK**.
4. Press the < or > soft key to select whether the reject setpoint activates above or below the programmed value.
5. Press the blue check for the Audio Set Point.
6. Press the value button associated with the audio set point.

The data entry pad appears.

7. Enter the set point and press **OK**.

2.2.4.3 Auto Sequencer

The auto sequencer is used to automatically perform testing on a part, to maximize testing throughput and to reduce the chances of accidentally accepting a bad part. The auto sequencer is used in conjunction with the reject and audio set point settings, which provide the criteria for pass or fail conditions. Within the auto sequencer feature, there are two variables that must be set, rough time and test time. The ROUGH TIME setting indicates to the system the maximum time it is allowed to be in roughing before the test fails. Ideally, the system goes into the roughing phase and then proceeds to TEST. The TEST TIME setting tells the system when to perform the test against the set point values. For example, you may set 20 seconds for the TEST TIME. At the end of 20 seconds, the system determines if the part has passed or not and then makes an indication by either going to VENT (Pass) or going to HOLD (Fail) and displaying the reject set point failure on the front panel.

- Press **Auto Sequencer Set-Up** on the Menus screen.

The Auto Sequencer Set-Up screen appears (Figure 2-10). The leak detector can be configured to automatically run through a complete test cycle (Start/Rough/Test/Vent).

During the test cycle, the system ensures that during the Rough Time the user-entered pressure transfer set points are met.

A *Pass* condition is indicated by the system reverting to the Vent mode upon completion of the test cycle. A *Fail* condition is indicated by the system reverting to the Hold mode, and all operating buttons being disabled except Vent. A failed condition also results in *Rejected* appearing on the Home screen, along with a reject set point activation upon completion of the test cycle. The status of the reject set points are available through the RS-232 line (see Appendix A “Communications Protocol”).

On completion of an automated test cycle, the leak detector captures the leak rate signal measured just prior to the end of the automated test cycle. This leak rate appears on the Home screen until the next test cycle is initiated.

VS Series Helium Mass Spectrometer Leak Detectors

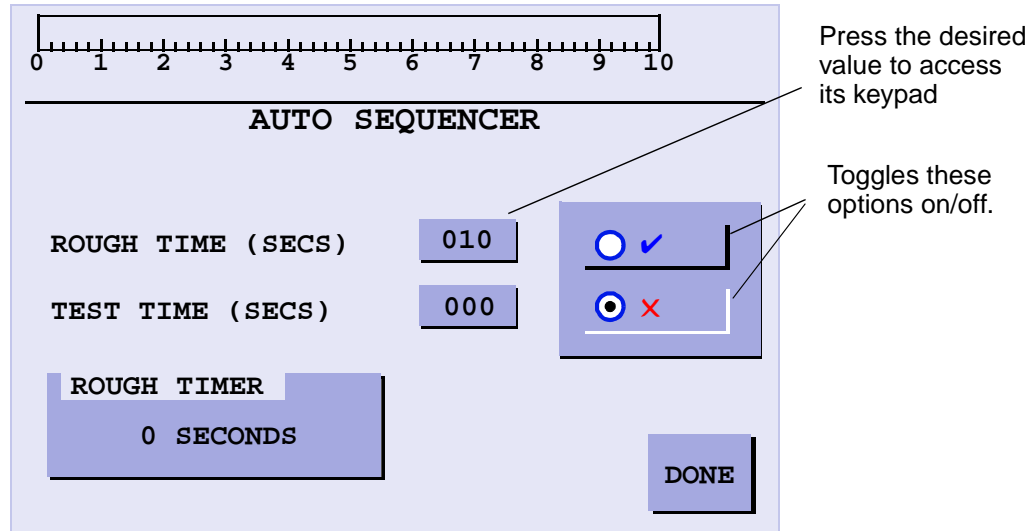

Figure 2-10 Auto Sequencer

Rough Time

Determines the amount of time that the leak detector is allowed to evacuate the test object to the Maximum Test Pressure (see Section 2.2.4.5 on page 2-27). In Auto Sequencer mode, the leak detector transfers into test as soon as the specified transfer pressure is met. If the specified test transfer pressure is not achieved within the pre-selected rough time, the system aborts the cycle and goes into Hold mode.

The Rough Time value is determined empirically and reflects the typical time required to rough the test object to the specified test pressure. Failure to achieve the test pressure within the pre-selected rough time indicates a gross leak in the test object or test fixturing, or that the time allowed was insufficient.

The rough timer records the amount of time the system spent in the roughing phase prior to it entering the TEST mode. The rough timer is intended to help you set up a *rough time* value since it can be difficult to predict accurately how long the system is in the roughing phase when you cycle. Put the system into TEST mode, the rough timer records and displays the rough time so that you can enter a rough time value close to what was recorded. For example, if the rough timer records a value of 12 seconds, you can then enter a value in the *rough time* that is slightly longer than what was recorded, 15 seconds for example. The rough timer only records a time when the auto sequencer is ON.

VS Series Helium Mass Spectrometer Leak Detectors

Test Time Determines the amount of time that the leak detector remains in test before it compares the measured leak rate with the selected reject set point. Allow sufficient time for the leak rate reading to stabilize before the system makes a pass/fail decision. This is a function of the part configuration and the leak rate specification. In Auto Sequencer mode, the leak detector remains in test for the entire duration of the preselected test time.

To configure the auto sequencer mode:

1. Press the blue check to turn on the Auto Sequencer.

The pass/fail criterion is based on the reject set points that are enabled.

2. Press the value button associated with the Rough time.

The data entry pad appears.

3. Enter the time and press **OK**.

4. Press the value button associated with the Test time.

The data entry pad appears.

5. Enter the time and press **OK**.

6. Press **TEST** and let the system record the actual time spent in roughing. After the test is complete, use the recorded rough timer value to set an appropriate rough time.

VS Series Helium Mass Spectrometer Leak Detectors

2.2.4.4 Leak Rate Ranging

- Press **Leak Rate Ranging** on the Menu screen.

The Leak Rate Ranging screen appears (Figure 2-11). Use it to setup and enable the Range Stop and Manual Range functions and to enable the High Pressure Test mode.

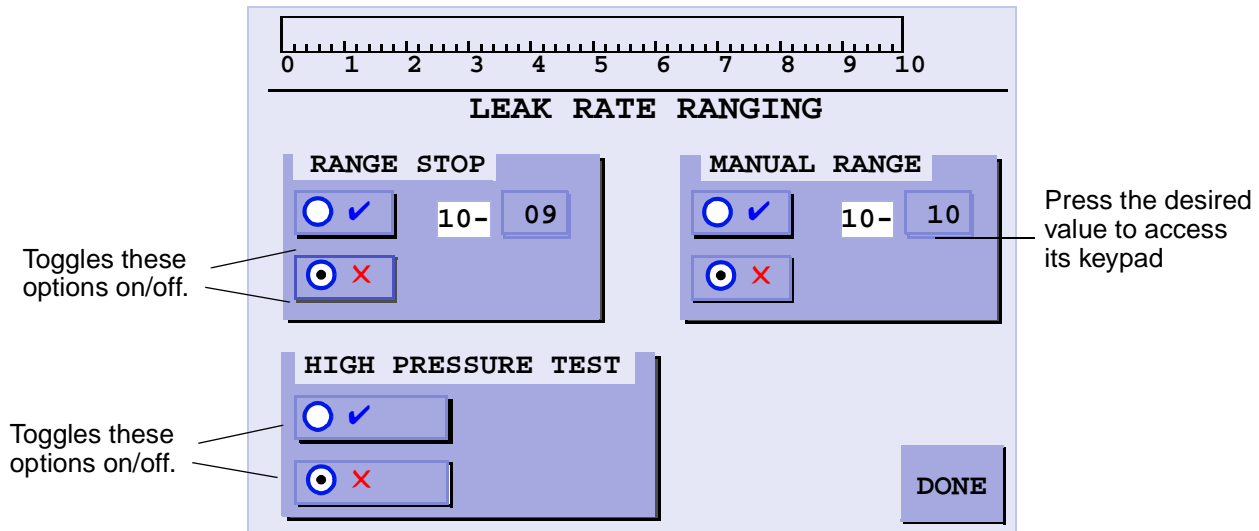

Figure 2-11 Leak Rate Ranging

High Pressure Test

Press the High Pressure Test blue check to enable High Pressure Test mode. The High Pressure Test LED illuminates when High Pressure Test mode is enabled and High Pressure Test appears on the Home screen. When High Pressure Test is selected, Range Stop defaults to 10^{-7} atm cc/sec. High Pressure Test sensitivity mode range is 10^{-4} to 10^{-8} atm cc/sec.

- When the leak detector is in Vent mode:
Turn the High Pressure Test feature on to start the test cycle. This automatically locks the leak detector into Contra-Flow™ Leak mode, and auto-ranges through all decades down to the most sensitive Contra-Flow range.
- When the leak detector is in Test mode:
Turn the High Pressure Test feature on to perform the same function, with the exception of performing the test cycle start sequence.

VS Series Helium Mass Spectrometer Leak Detectors

Range Stop

Configures the leak detector so that it only auto-ranges down to the pre-selected decade entered in the Range Stop variable field. For example, if range stop was enabled and the range stop setting was 10^{-07} , the most sensitive range that the leak detector would displays is full scale 10^{-7} atm cc/sec. To allow auto-ranging to the maximum sensitivity of the system, turn Range Stop Off.

This feature is useful when a product specification is more than one decade less stringent than the actual sensitivity of the leak detector. If the leak detector is capable of displaying full scale $< 10^{-11}$ atm cc/sec, but the test specification is only in the 10^{-7} atm cc/sec range, then setting the range stop to 10^{-08} atm cc/sec would reduce the test cycle time by eliminating the need for the leak detector to reach its most sensitive scale during each test cycle.



Activating the range stop extends the sensitivity requirements for calibration, thus eliminating unnecessary calibration errors (see Table 2-5).

Table 2-5 Range Stop/Sensitivity Requirements

Range Stop	Max Gain	MDL
OFF	6.9	5.00E-12
ON at		
-11	6.9	5.00E-12
-10	10	5.00E-11
-9	20	5.00E-10
-8	50	5.00E-09

Manual Range

Configures the leak detector so that it only displays the pre-selected decade entered in the manual range variable field. For example, if the manual range feature was enabled and the manual range variable was set to 10^{-06} , then the leak rate decade displayed on the LED bar graph during testing would be the 10^{-06} atm cc/sec range only. This feature is useful when the concern is only with monitoring the leak rate measurement within a single decade.

VS Series Helium Mass Spectrometer Leak Detectors

To configure the leak rate ranging:

1. Press the Range Stop blue check button.
2. Press the associated Range Stop Value button.
The data entry pad appears.
3. Enter the value and press **OK** to save the value.
4. Press the Manual Range blue check button.
5. Press the value button associated with the Test time.
The data entry pad appears.
6. Enter the value and press **OK** to save the value.
7. Press the High Pressure Test blue check button, if required.

2.2.4.5 Transfer Points

- Press **Transfer Points** on the Menu screen.

The Transfer Points screen appears (Figure 2-12). Use it to set the pressure at which the system goes into Test.

The transfer pressure settings can be adjusted to lower values for specific applications. The limit on the maximum test pressure prevents the operator from inadvertently setting the leak detector to transfer into test at too high a pressure, which would result in excessive spectrometer contamination or ion source filament failure.

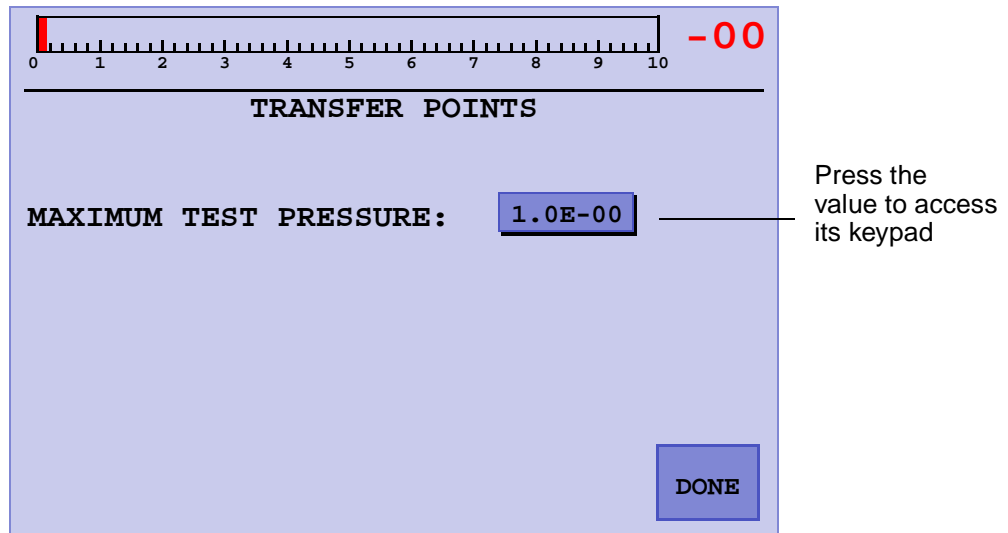

Figure 2-12 Transfer Points

Maximum Test Pressure

Determines the test pressure cross over point at which the system transfers from Roughing into Test and then into the Contra-Flow Test mode. In the Contra-Flow Test mode, the gas sample is pumped through the leak detector and swept across the high vacuum pump foreline. The Contra-Flow mode allows for higher sensitivity testing at exceptionally high test pressures.

The maximum test port pressure is 10 Torr.



NOTE

The transfer pressure from the Test mode to the Fine Test mode is set at 100 milliTorr (1.0E-1 Torr). You may wish to lower that value under certain circumstances. The mid-stage transfer pressure limit is adjustable from 1 to 100 milliTorr via an RS-232 command (see ML-XFER and INIT-ML-XFER in Section A "Communications Protocol" on page A-1). The pressure limit is not adjustable using the display.

2.2.4.5.1 Transfer Points with Stabilization Wait Timer

Figure 2-13 shows the Transfer Points screen.

NOTE

This feature is available November 2010.

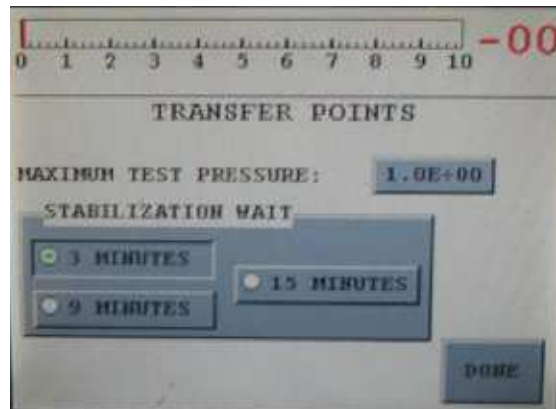

Figure 2-13 Transfer Points with Stabilization Wait Timer

Stabilization Wait

This appears on the Home screen after a successful startup. This timer is necessary for the spectrometer stabilization and degassing. The factory default is 3 minutes. It is highly recommended for those customers who infrequently use the leak detector or expose the leak detector to aggressive applications to select the **9** or **15** minute selection. For example: Select **9** minutes for a leak detector that is used once a week or select fifteen minutes for a leak detector that is used once a month or less.

VS Series Helium Mass Spectrometer Leak Detectors

2.2.4.6 System Information

- Press **System Information** on the Menu screen.

The System Information screen appears (Figure 2-14).

Details of the current leak detector setup and operating conditions are displayed. The left column displays filament status, reject set point status, turbo status, auto sequencer status, and audio set point status. The right column displays the calibrated leak setting, leak rate range settings, and the sensitivity configuration. Table 2-6 describes the displayed system information in detail.

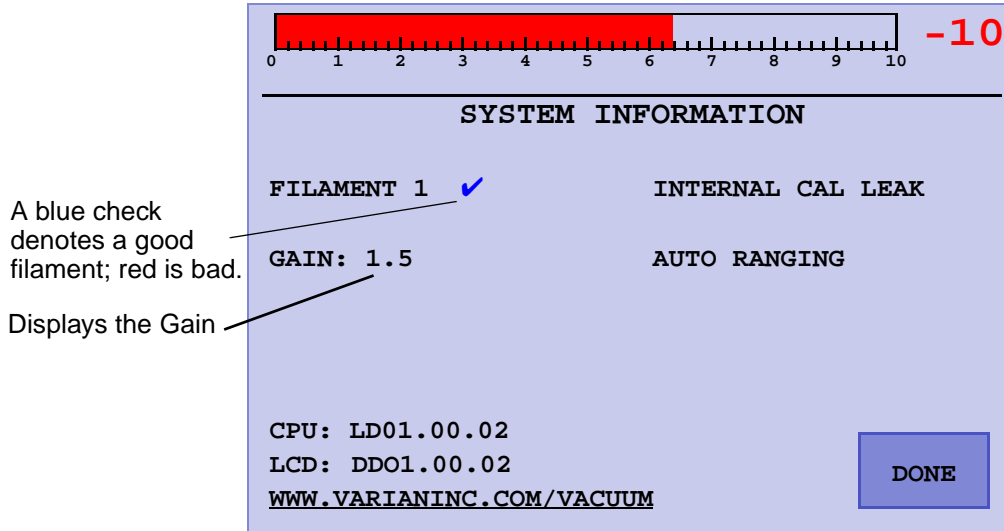

Figure 2-14 System Information

Table 2-6 System Information Screen Conditions

Condition	Display	Description
Audio Set Point See Section 2.2.4.2 "Reject and Audio Set Points" on page 2-18.	Audio Set Point: Active	Audio Set Point is active.
	Audio Set Point: Inactive	Audio Set Point is inactive.
Auto Sequencer See Section 2.2.4.3 "Auto Sequencer" on page 2-21.	Auto Sequencer: On	Auto Sequencer (automatic test cycle) is enabled.
	Auto Sequencer: Off	Auto Sequencer (automatic test cycle) is disabled.
Calibration Set-Up See Section 2.2.4.1 "Calibration Set-Up" on page 2-16.	Int Cal Leak	System is set to calibrate to the internal standard leak.
	Ext Cal Leak	System is set up to calibrate to an external standard leak.

VS Series Helium Mass Spectrometer Leak Detectors

Table 2-6 System Information Screen Conditions (Continued)

Condition	Display	Description
Ion Source Filament See Section 3.1.2 "Manual Tuning" on page 3-7.	Filament 1 Off	Filament 1 is selected and not lit.
	Filament 1 On	Filament 1 is selected and lit.
	Filament 2 Off	Filament 2 is selected and not lit.
	Filament 2 On	Filament 2 is selected and lit.
Gain	Gain (Gain Value)	Displays the gain that applied to the leak rate. The actual helium signal is multiplied by the gain value to read the correct, calibrated leak rate.
Leak Rate Range See Section 2.2.4.4 "Leak Rate Ranging" on page 2-24.	Auto Ranging	System is set to auto range through the leak rate scale.
	Manual Ranging	System is set for manual range control.
Range Stop See Section 2.2.4.4 "Leak Rate Ranging" on page 2-24.	Range Stop -[Exp]	System is set to display the most sensitive leak rate range, 10 ^[Exp] . The range stop line shows only if range stop is on.
Reject Set Point See Section 2.2.4.2 "Reject and Audio Set Points" on page 2-18.	Reject# 1,2,3,4 Active <i>This page intentionally left blank.</i>	Reject set points displayed are active; this line is blank when all set points are disabled or inactive.
Software Version and Varian Web site		Shows the software version of the CPU board (L version) and software version of the display board (D version). Also shows the Varian web address for customer use. See the back cover of this manual for a listing of our sales and service offices.
Split Flow See Section 2.2.4.1 "Calibration Set-Up" on page 2-16.		Shows split flow, only if the feature is turned on. To change the status, go to the Advanced Parameters screen.
Vent Lockout Status See Section 2.2.4.7 "Control Panel Access" on page 2-31.		Shows the status of the vent lockout feature only if it is on. To change the status of the vent lockout feature, go to the Control Panel access screen.

2.2.4.7 Control Panel Access

- Press **Control Panel Access** on the Menu screen.

The Control Panel Access screen appears (Figure 2-15). Use it to enable the Vent and Panel lockouts.

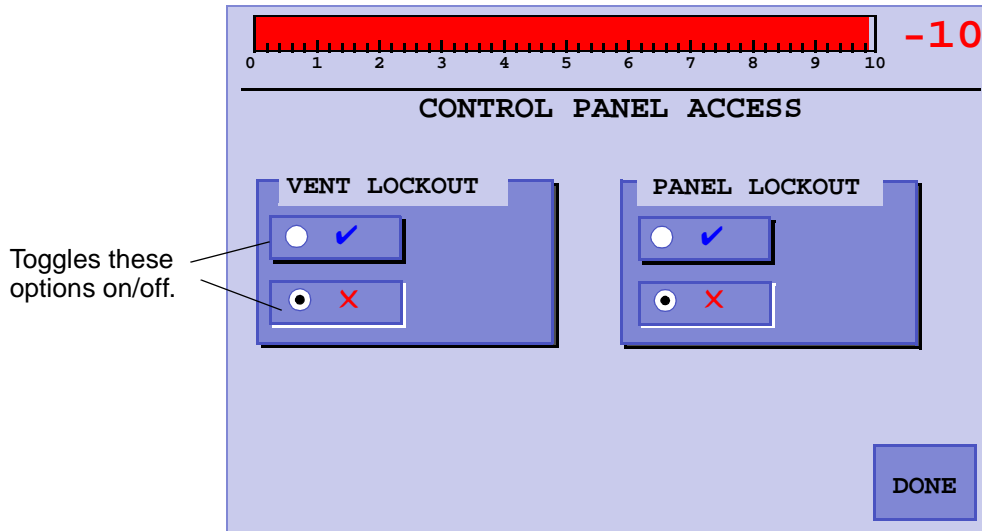

Figure 2-15 Control Panel Access

Vent Lock	Disables the VENT button. This option prevents accidental system venting during test while under remote or PLC control. The Vent Lock feature is not active when the Auto Sequencer is on.
Panel Lockout	Disables the front panel buttons, TEST and VENT and access to the Control Panel screen. This is primarily used while the system is under PC or PLC control.

This page intentionally left blank.

Section 3. Set-Up

3.1 Set-Up Menu

The Set-Up menu screen contains buttons for functions that deal with machine performance, tuning, and maintenance issues. All sub-screens below this level have a Home button that returns the program directly to the Home screen (Figure 1-7 on page 1-15).

- ❑ Press **Set-Up** on the **Menu** screen to open the Set-Up screen. The Set-Up menu can be password protected. See Section 3.1.9 “Password” on page 3-24.
- ❑ Press the right arrow and then **Maintenance** on the Set-Up screen to access the password change mechanism and enable or disable the password feature.

The password can also be read off the RS-232 connector (see Appendix A “Communications Protocol”).

CAUTION



The items configured using the Set-Up sub-screens significantly affect the performance of the leak detector and must only be accessed by trained service personnel.

Many of the values for the parameters included on the Set-Up sub-screens are calculated when the leak detector performs functions such as Calibrate and tuning. Changing these values can cause unreliable test results.

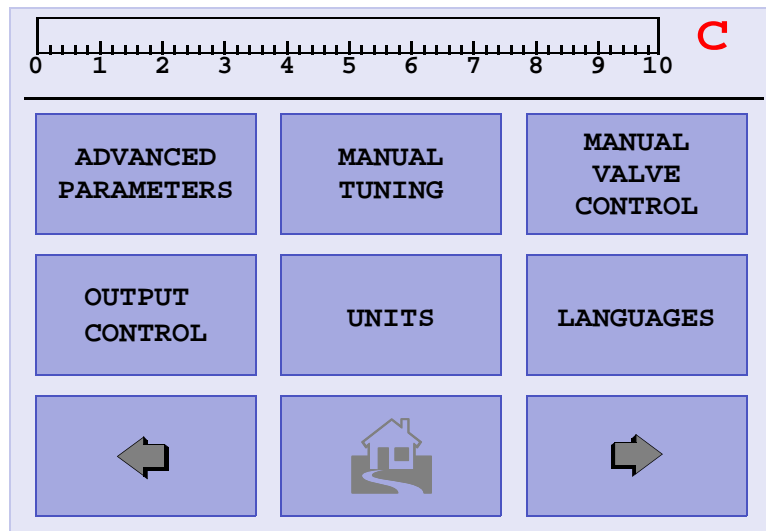

Figure 3-1 Set-Up Screen - Initial

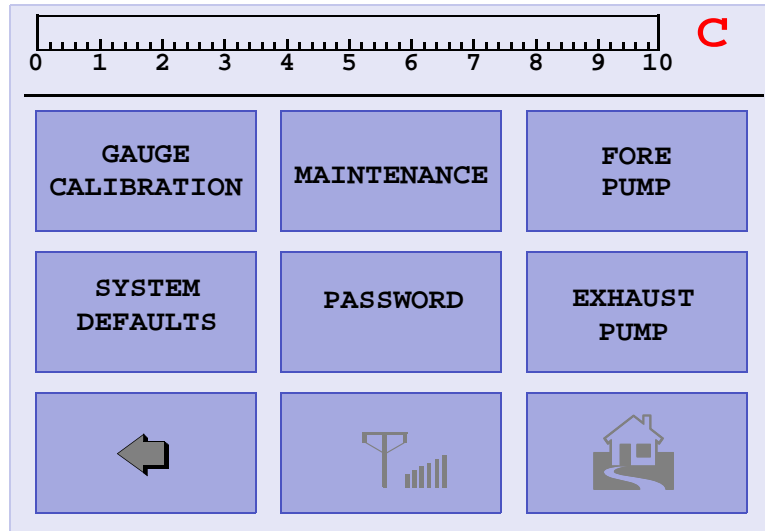

Figure 3-2 Set-Up Screen - Second

See the following sections for these screens (all accessed from the Set-Up screen):

- ❑ Section 3.1.1 “Advanced Parameters” on page 3-3
- ❑ Section 3.1.2 “Manual Tuning” on page 3-7
- ❑ Section 3.1.3 “Manual Valve Control” on page 3-10
- ❑ Section 3.1.4 “Output Control” on page 3-13
- ❑ Section 3.1.5 “Units” on page 3-15
- ❑ Section 3.1.6 “Languages” on page 3-16
- ❑ Section 3.1.7 “Gauge Calibration” on page 3-17
- ❑ Section 3.1.8 “Maintenance” on page 3-19
 - ❑ Section 3.1.8.3 “Internal Calibrated Leak” on page 3-22
 - ❑ Section 3.1.8.2 “Date & Time Set-Up” on page 3-21
 - ❑ Section 3.1.8.3.1 “Cal Leak Expiration Set-Up” on page 3-23
- ❑ Section 3.1.9 “Password” on page 3-24 (Software revision 3.11)
- ❑ Section 3.1.10 “Fore Pump Set-Up and Exhaust Pump” on page 3-25
 - ❑ Section 3.1.10.1 “Date Serviced” on page 3-26
- ❑ Section 3.1.11 “Wireless” on page 3-27

3.1.1 Advanced Parameters

- Press **Advanced Parameters** on the Set-Up screen and the Advanced Parameters screen appears (Figure 3-3).

Use this screen to configure the Auto-Zero < 0, Split Flow Factor, and spectrometer Gain.

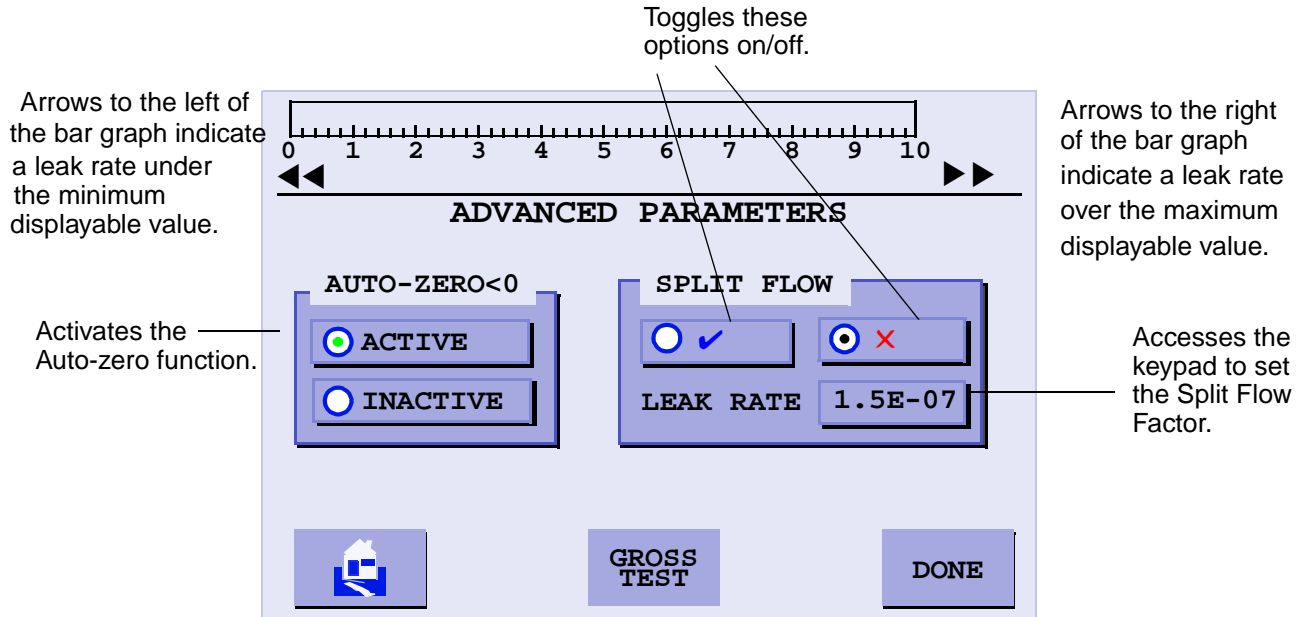

Figure 3-3 Advanced Parameters

Auto-Zero<0 Active

Adjusts the zero reference point automatically and continually to the correct zero value when the helium background level drops below the previously set zero reference point. This feature ensures that the leak detector maintains a correct balance value after a previously zeroed background signal naturally cleans up (background helium is pumped away).

When the Auto-Zero < 0 feature is in the process of re-adjusting the zero reference point, the arrows located on the left end of the bar graph illuminate. These arrows indicate that the measured helium leak rate is currently less than the minimum displayable value. The arrows may flash briefly as the system recovers from a leak indication and the displayable leak rate approaches zero. If the Auto-Zero < 0 is turned on, the arrows may also flash briefly as the system resets the zero point to a lower value. The leak detector does not display a leak rate while the arrows are on. If the arrows remain on for more than a few seconds, press Zero to set operating parameters to the correct zero value. This situation can occur if the leak detector had not been fully warmed up when a previous calibration was initiated.

VS Series Helium Mass Spectrometer Leak Detectors

Auto-Zero < 0 Inactive When Auto-Zero < 0 is inactive, the leak detector does not automatically adjust the zero reference point when the helium background level drops below the previously set zero reference point. In this condition, a leak less than the previously set zero value is not indicated by the system. Instead, the arrows remain lit, indicating that the background level is below the previously set zero reference point. Press Zero on the front panel to readjust the zero reference point manually. This clears the lights.



For High Pressure Test/Sniffing mode, de-activation (Inactive AZ<0) is highly recommended. Manual Zeroing produces a more desirable performance, thus eliminating false leaks due to fluctuations in test port pressure while in test.

Split Flow

Activating the split flow option properly characterizes the system to an external calibrated leak, which is influenced by additional vacuum pumping sources. These separate vacuum pumping sources reduce the amount of helium measured by the leak detector.

The split flow option is very useful for external calibrations where external gain factors exceed the limit of 50 due to a high helium background (Range Stop E-8). The split flow factor is also useful for calibrating to a standard leak while in the sniffing mode (High Pressure Test).

Gross Test

Allows the operator to locate leaks while the system is in roughing mode. The test indicates the presence of a leak at high pressures only and does not display a leak rate value.

- Gross Test is activated in the ADVANCED PARAMETER menu.
- Once activated, the GROSS TEST button appears on the Home screen. Press *GROSS TEST* to enter the screen.
- There is an audio tone for Gross Leak testing, which increases as the leak increases.
- Gross Test only works when the test port pressure is between 10 and 150 Torr and remains constant ($\pm 2\%$ between previous and current pressure readings).
- The Gross Leak test stops if the system goes into Backing, Test or Fine TEST mode.
- Activating the Auto Sequencer button terminates the Gross Leak test.
- The HOLD button is inactive while in Gross Leak test mode, as the system is in roughing mode.

3.1.1.1 Split Flow Operation

Ground rules and assumptions:

- ❑ The software limits split flow to no more than 1000 times (3 decades). If the split flow is turned ON and the leak rate entered is more than 1000 times higher than the system leak rate, the system will not allow the split flow to turn ON and <> appears.
- ❑ At the main screen, the system blinks the split flow symbol  when split flow is ON.
- ❑ When split flow is turned ON, it displays the corrected leak rate but it knows the real leak rate value.
- ❑ When ZERO is pressed with when split flow ON, the system zeroes out background up to a limit equal to the maximum split flow value.

To activate split flow:

1. Place the system into TEST mode and let the leak rate stabilize. Calibrate the system.
2. Press the Split Flow blue check button. The leak detector prompts you to enter the leak rate for the customer's calibrated standard leak (what the leak rate should be).

The leak detector displays the corrected leak rate, essentially calculating a split flow gain value. The leak detector automatically calculates the split flow factor, turns on and calculates the range stop, based on the split flow factor.

When Split Flow is turned OFF, the system reverts back to the uncorrected leak rate. This process must be repeated when reactivating split flow.

For Split Flow: Sniffer Mode (High Pressure Test) External Calibration: (*E-6, E-5, E-4 std. leaks only*) *AZ<0 Inactive:*

1. Install the power/sniffing probe in the leak detector test port and press **Test**. Transfer Point must be equal to or greater than 2 Torr but less than 10 Torr.
2. Use the power probe to adjust the test port pressure between 500mTorr and 1 Torr for optimum response and cleanup performance.
3. Initiate a full internal calibration.
4. Go back in Test and Zero out the system background.
5. Install the power probe in the outlet of the standard leak and allow for system stabilization.
6. Activate the Split Flow option and input the value of the calibrated leak and press **OK**.
7. Remove the probe from the calibrated leak and verify that the that the leak detector cleans up.

VS Series Helium Mass Spectrometer Leak Detectors

8. Check to see if the leak rate signal is somewhat unstable and drifts lower than the calibrated value. If so, lower the test port pressure with the power probe or utilize a larger external calibrated leak.

Vacuum external calibrations where external gain factors exceed the limit of 50 due to a high helium background (Range Stop E-8) can be performed as above, with the exception that the background must be zeroed out prior to initializing split flow.

3.1.2 Manual Tuning

- Press **Manual Tuning** on the Set-Up screen and the Manual Spectrometer Tuning screen appears (Figure 3-4).

Use this screen to manually adjust the parameters of the ion source in the spectrometer for a maximum helium signal.

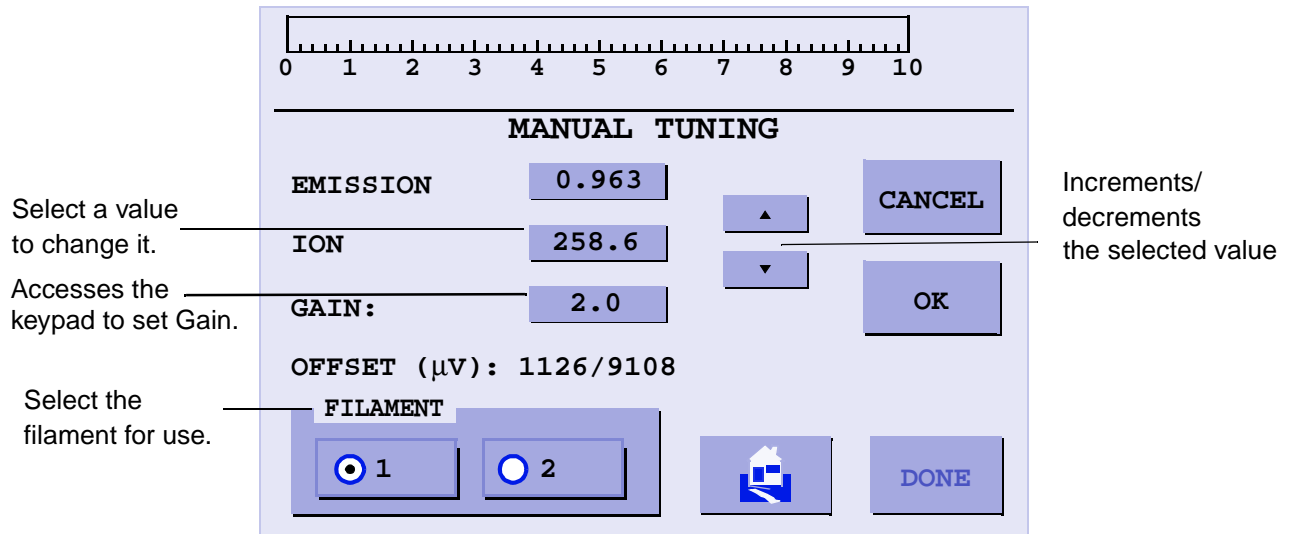

Figure 3-4 Manual Tuning

Emission Current	Displays the value of the existing Emission current of the spectrometer Ion Source and allows for emission current adjustment. The emission current parameter tunes the leak detector, maximizing the leak detector output for a peak helium signal. Typical Emission current values range from 0.6 mA to 1.2 mA.
Ion Voltage	Displays the current ion voltage value of the spectrometer Ion Source. The ion voltage parameter tunes the leak detector, maximizing the leak detector output for a peak helium signal. Typical ion voltage values range from 250 VDC to 270 VDC. The ion voltage value is automatically adjusted and set during the full calibration routine.

VS Series Helium Mass Spectrometer Leak Detectors

Filament

Switches between Filament 1 and 2. The filament selection can be performed manually, but occurs automatically if the current operating filament burns out. A calibration routine is recommended every time the operating filament is changed.

The change appears on the Home and System Information screens and *C* flashes on the Home screen to indicate that calibration is required.

NOTE



Replace the filament inside the spectrometer as soon as it is convenient after the spare filament has been put into use.

Gain

Displays the current value of the Gain of the system. Gain is used to scale the indicated value of a known leak to agree with a known correct value. The gain parameter is adjusted after the leak detector has been tuned to helium. It is automatically set by the Calibrate Procedure (see Section 2.2.4.1 “Calibration Set-Up” on page 2-16). Use the value button (next to Gain) to change the Gain value.

NOTE



Changing Gain changes Zero by the same percentage, which can affect system transfer points.

Typical gain values range from 0.8 to 3.0. The higher the gain, the more noise shows up in the least sensitive range.

To change a manual tuning parameter:

1. Press the desired parameter.

When you press the box containing the desired variable, a highlighted indicator appears to the right of the numbers.

NOTE



*Once a change of value is initiated, you can press **Cancel** to exit the screen and revert to the original value*

2. Press the Up or Down arrow to peak the helium signal.

NOTE



*Do not press the **ESC** box before pressing the **OK** box. This causes the selected parameter to revert to its previously stored value.*

3. Press **OK** to accept the changes and to store the new parameter value in the leak detector memory.
4. Press **Done** to exit the screen and return to the previous menu screen.

VS Series Helium Mass Spectrometer Leak Detectors

To manually tune the leak detector:

1. Place the system in TEST mode.
2. Navigate to the Control Panel and turn the STD LEAK ON.
3. Navigate to the Calibration Set-Up screen and write down the INTERNAL CALIBRATED LEAK value. This value is temperature compensated.
4. Navigate to the Manual Tuning screen and:
 - ❑ Set the GAIN to 1.0.
 - ❑ Set the EMISSION to between 0.600 and 0.6500.
 - ❑ Adjust the ION value up or down to attain the maximum value. Ideally, the ION value should be between 250 and 270.
 - ❑ Adjust the EMISSION to attain the maximum value. Ideally, the EMISSION value should be between 0.600 and 1.200.
 - ❑ Set the GAIN so that the leak rate on the screen matches the value of the internal leak you wrote down.
5. Navigate to the CONTROL PANEL and turn the STD LEAK OFF.

3.1.3 Manual Valve Control

- Press **Valve Control** on the Set-Up screen and the Manual Valve Control screen appears (Figure 3-5).

Use this screen to manually control the valves in the leak detector vacuum system for troubleshooting purposes.

See Figure 3-7 on page 3-12 for an illustration of the leak detector vacuum system.

CAUTION



Manipulation of the valves using the Manual Valve Control screen must only be performed by persons who are extremely familiar with the leak detector as damage to critical components (e.g., spectrometer, turbo) could occur.

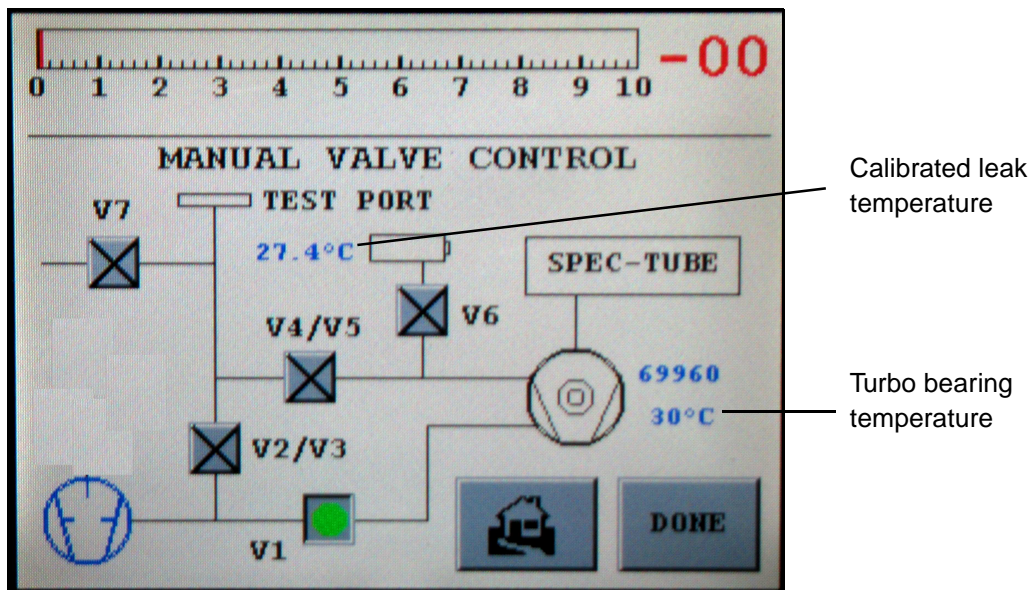

Figure 3-5 Manual Valve Control

- Press the box corresponding to that valve to change the state of a specific valve. The valve changes state and the box toggles from an X indication (CLOSED) to a Green Circle (OPENED). The valve state (displayed to the right of each valve control box) represents the current state of the corresponding valve. The normal operating states of valves for single mechanical pump systems are provided in Table 3-1 on page 3-12.

VS Series Helium Mass Spectrometer Leak Detectors

Figure 3-6 shows this screen for the PD03; only the calibrated leak and bearing temperature are accessible.

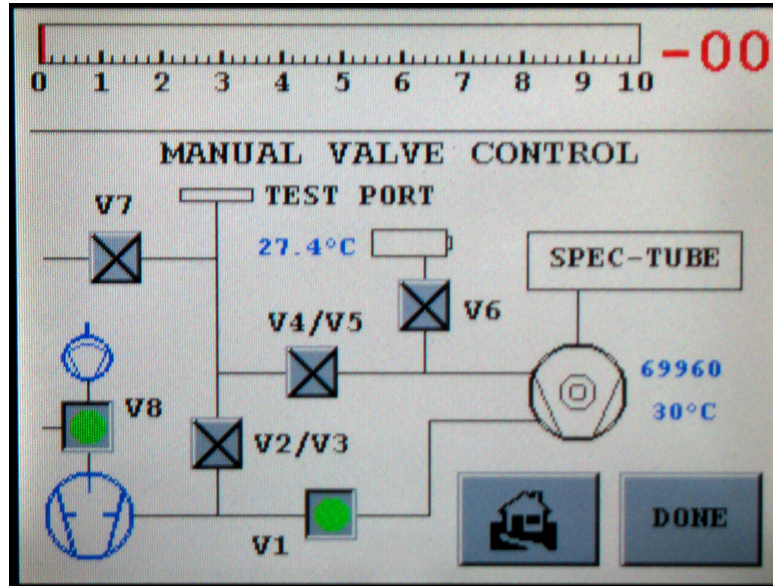

Figure 3-6 Manual Valve Control - PD03

VS Series Helium Mass Spectrometer Leak Detectors

Table 3-1 Leak Detector Valve State Table - Single Mechanical Pump System

Leak Detector Operating State	V1 Foreline Valve	V2/V3 Contra-Flow w Valve Test Mode	V4/V5 Midstage Valve Fine Test Mode	V6 Calibrated Leak	V7 Vent Valve	V8* Ballast Valve	V8* Exhaust Valve
Vent	O	C	C	C	O	C	O
Rough	C	O	C	C	C	C	C
Gross Leak Test	C	O	C	C	C	C	N/A
Contra-Flow Test	O	O	C	C	C	C	O
Midstage Test	O	C	O	C	C	C	O
Hold	O	C	C	C	C	C	O
Sniff	O	O	C	C	C	C	O
Read Std Leak	O	C	C	O	C	C	O

O: Open

C: Closed

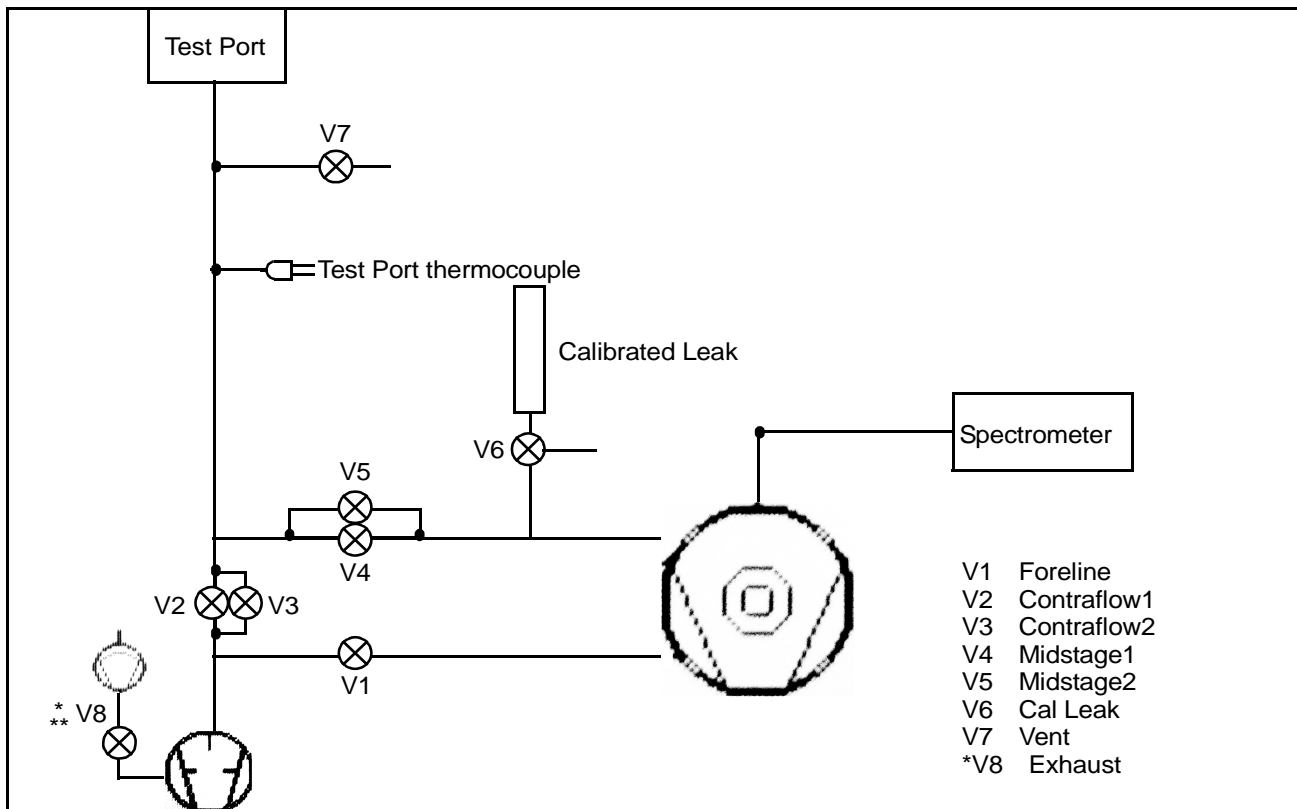

Figure 3-7 Leak Detector Vacuum System Diagram

* Normally open valve, powered closed during all operations. ** Model PD03 during the roughing sequence.

3.1.4 Output Control

- Press **Output Control** and the Output Control screen appears (Figure 3-8).

Use this screen to select the desired leak rate output, and Bar Graph display mode.

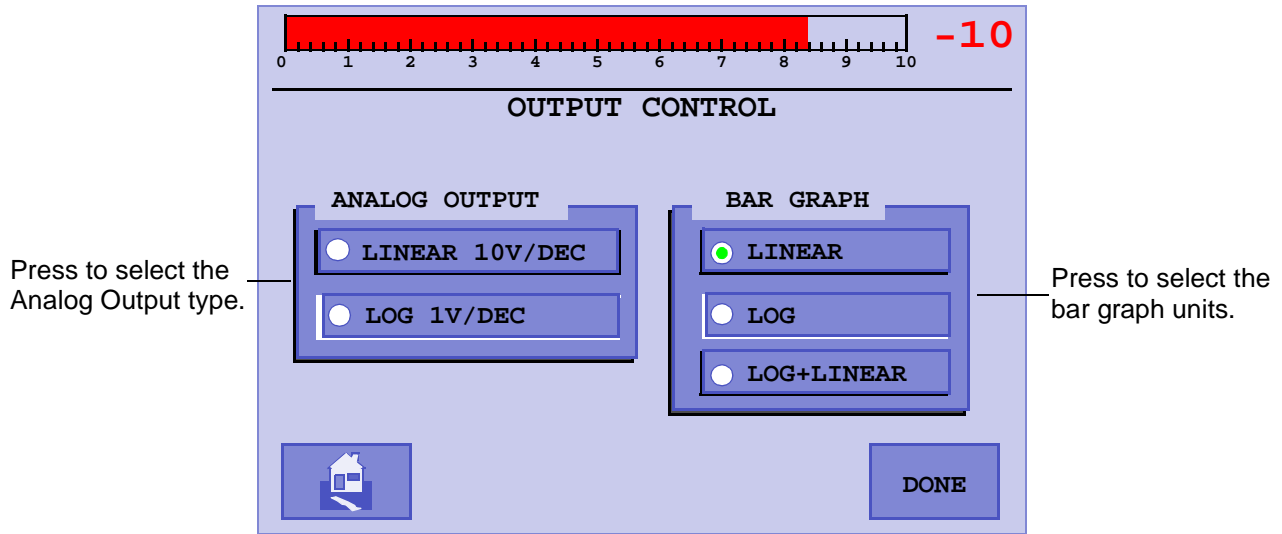

Figure 3-8 Output Control

Analog Output

Configures the analog outputs:

- Linear 10 V/DEC
Linear output running from 0 to 10 V for each decade. Figure 3-9 shows the linear output voltage as a function of leak rate.
- Log 1 V/DEC
Log output at 1 V per decade. Figure 3-10 shows the log output voltage as a function of pressure.



*For added accuracy add .06 to V_{out}
Leak Rate = $10^{V_{out} + .06} / 10^{11}$.*

Bar Graph

Configures the bar graph:

- Linear Only
The linear bar graph leak rate appears across the top of all screens when selected. In the Linear Bar Graph display mode, the bar graph display represents the mantissa of the leak rate, spanning from 0 to 10. The numerical display (located to the upper right of the bar graph) indicates the leak rate exponent value. This mode offers exceptional resolution within a decade.

VS Series Helium Mass Spectrometer Leak Detectors

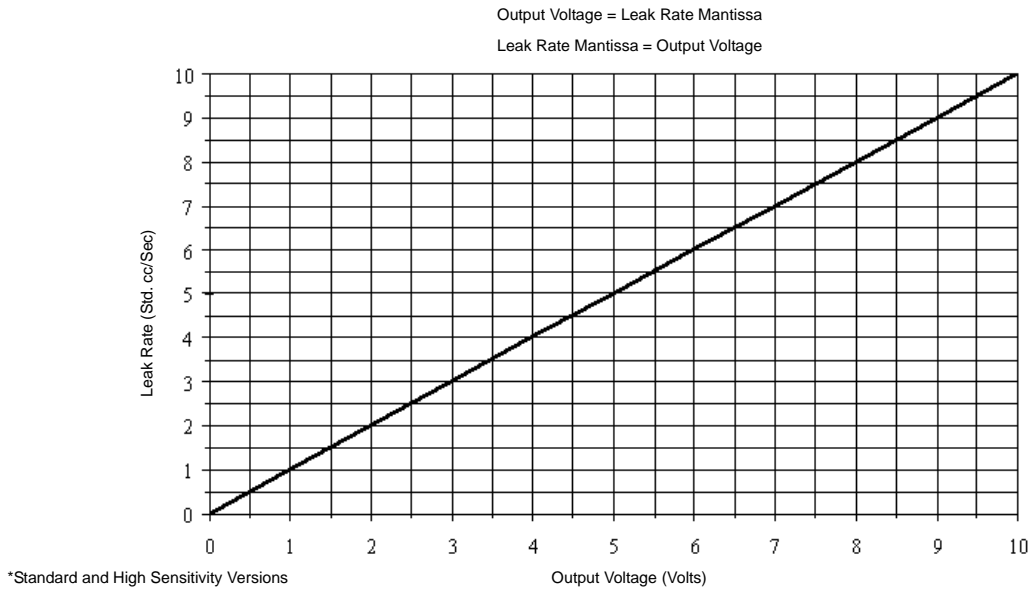

Figure 3-9 Leak Detector Linear Output Voltage

Log Only

The log bar graph leak rate appears across the top of all screens. In Log Bar Graph display mode, the bar graph display represents the entire leak rate range of the leak detector, spanning from 10^{-11} atm cc/sec to 10^{-4} atm cc/sec. The numerical display (located to the upper right of the bar graph) is not lit in this mode.

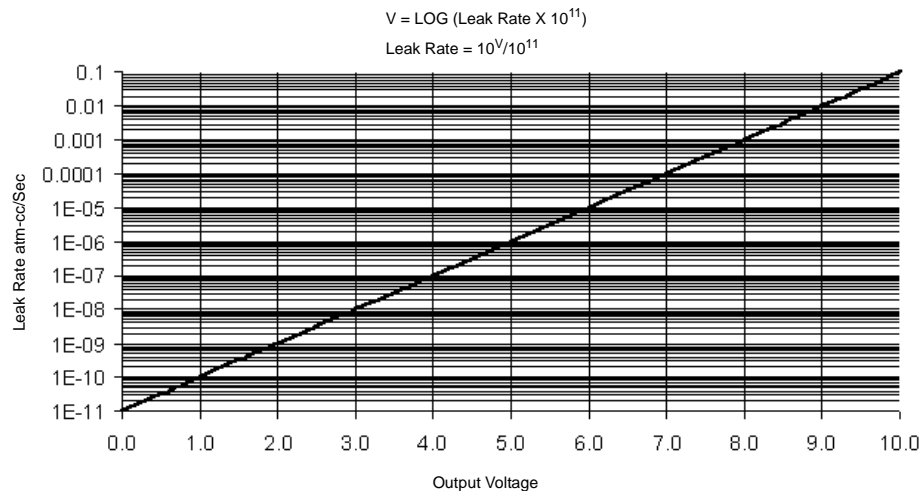

Figure 3-10 Leak Detector Logarithmic Output Voltage

Log + Linear – both log and linear bar graphs appear across the top of the Home screen while all other screens only display the linear bar graphs across the top.

3.1.5 Units

- Press **Units** on the Set-Up screen and the Units screen appears (Figure 3-11).

Use this screen to configure the Leak Rate and Pressure Units used on the leak rate bar graph.

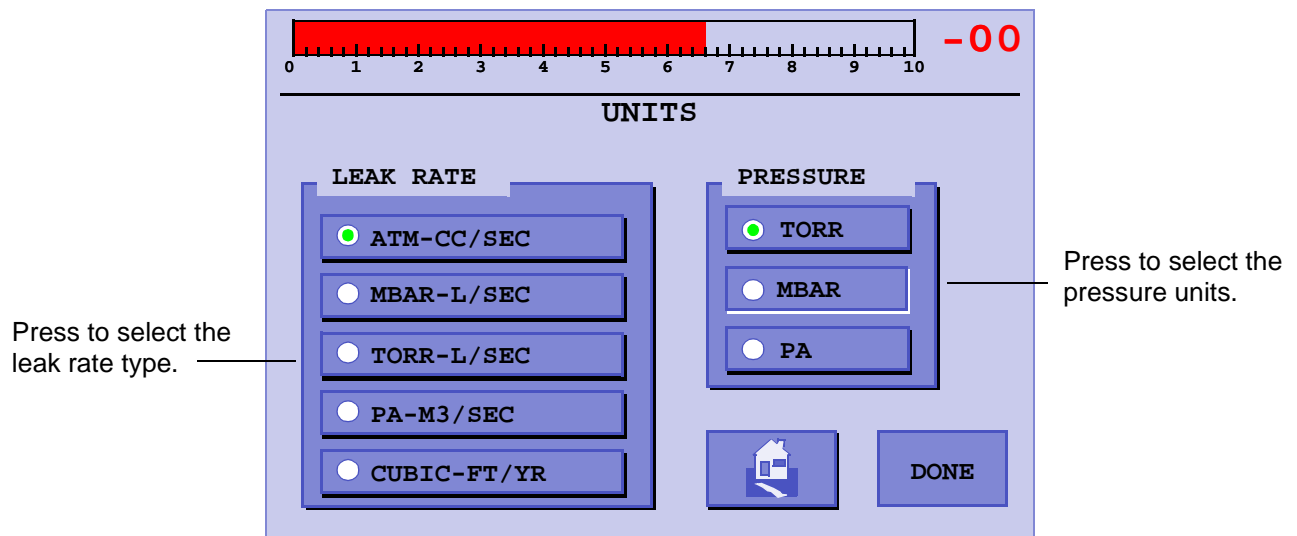

Figure 3-11 Units

Leak Rate Units	Switches the leak rate units between atm-cc/sec, mbar-l/sec, Torr-l/sec, Pa-m ³ /sec., and Cubic-ft/yr.
Pressure Units	Switches the test port pressure units between Torr, mbar, and Pa.

3.1.6 Languages

- Press **Language Set-Up** on the Set-Up screen and the Languages screen appears (Figure 3-12).

Use this screen to select a language.

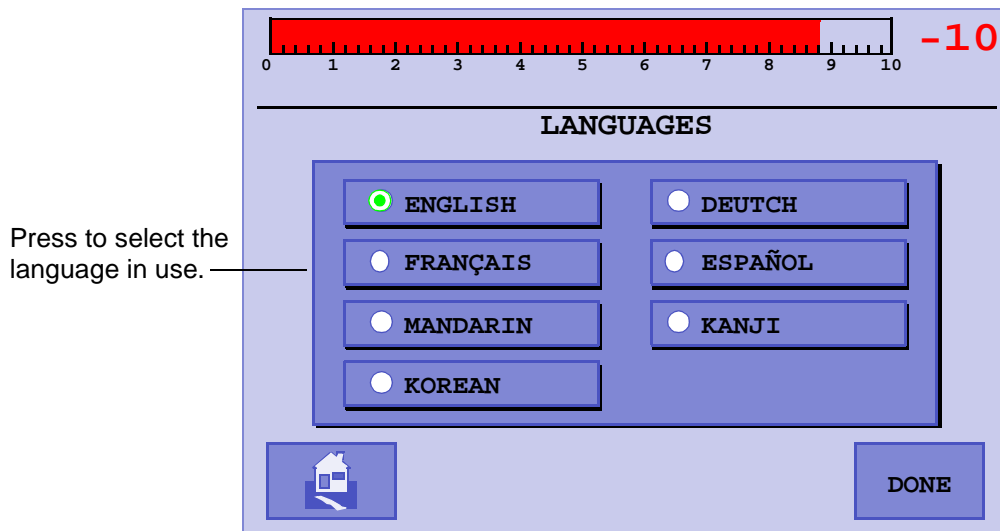

Figure 3-12 Languages

3.1.7 Gauge Calibration

- Press **Gauge Calibration** on the Set-Up screen and the Gauge Calibration screen appears (Figure 3-13).

Use this screen to perform a calibration on the test port thermocouple gauge.

Calibrate the thermocouple gauge for the most accurate operation. To calibrate the gauge:

1. Set a calibration point at atmosphere.
2. Set a calibration point at a low vacuum level ($\leq 1E-4$ Torr).

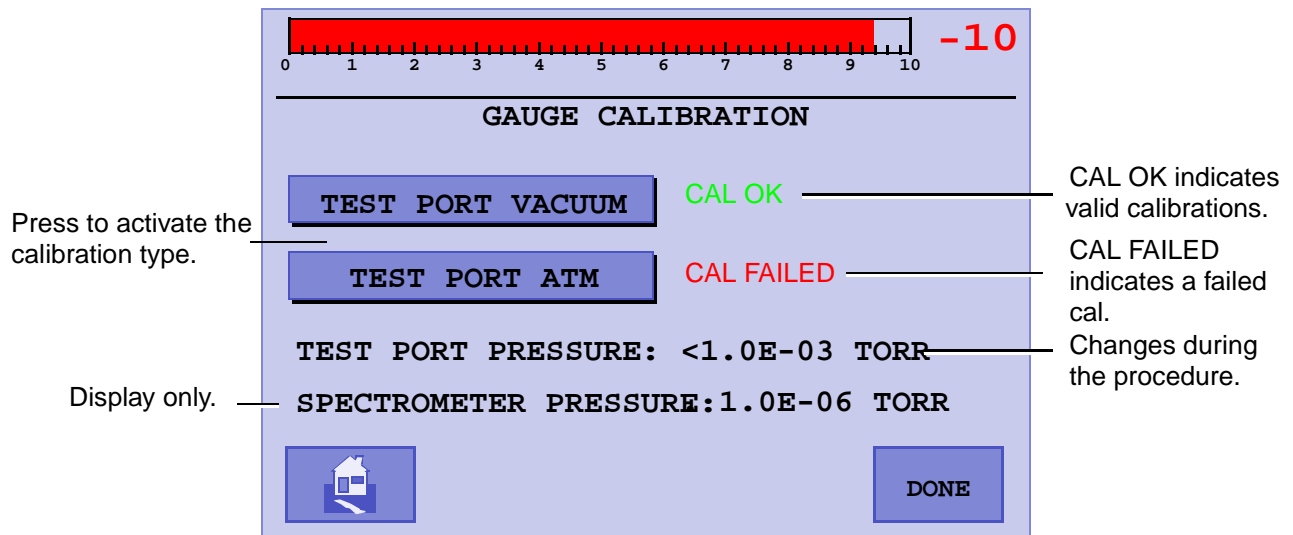

Figure 3-13 Gauge Calibration

Test Port Vacuum	Calibrates the thermocouple gauge zero value. Do this at or below 1E-4 Torr.
Test Port ATM	Sets the thermocouple atmospheric value. Perform this operation only when the test port is at atmosphere.
Test Port Pressure and Spectrometer Pressure	The Test Port Pressure and the Spectrometer Pressure values appear on this screen for reference.
Test Port Pressure Gauge Calibration Procedure	Calibrates the test port pressure thermocouple gauge. Perform both the Vacuum and Atmospheric Calibration procedures in the order written, TEST PORT VACUUM and the TEST PORT ATM.



Display of <1.0E-03 indicates the pressure is less than the lowest displayable pressure of the TC gauge which is 1.0E-03.

3.1.7.2 Vacuum (Low Pressure) Calibration

To perform Vacuum Calibration:

1. Verify that the leak detector is in the System Ready condition and that a test port cap is in place.
2. If the system is not already in Vent mode, press **VENT**.
3. Press **Test** and verify that the leak detector transfers to *Fine Test* mode, displaying 10^{-9} atm cc/sec or lower.
4. Wait approximately 5 minutes for the vacuum system pressure to stabilize.
5. Press **Test Port Vacuum**.

You will receive one of the following messages:

- A *Cal OK* indicator, to the right of the Test Port TC Zero box confirms that the calibration was successful.
- A *Failed* message indicates that the calibration was not successful.

A *Failed* message results from a defective or contaminated thermocouple gauge, or the fact that the actual pressure was not at or near zero. Verify the latter case using an appropriate vacuum gauge installed on the test port.

6. Press **Done** to leave the screen and return to the previous menu.

3.1.7.3 Atmospheric Calibration

To perform Atmospheric Calibration:

1. If the system is not already in Vent mode, press **VENT**.
2. Wait approximately ten seconds for the test port pressure to stabilize, then move to the Gauge Calibration screen (Figure 3-13 on page 3-17).
3. Press **Test Port Atm**.

You will receive one of the following messages:

- A *Cal OK* indication, to the right of the Test Port TC Atm box, confirms that the calibration was successful.
- A *Failed* message indicates that the calibration was not successful. This is the result of a defective or contaminated thermocouple gauge, or that the actual pressure was not at or near atmosphere. Verify the latter case using an appropriate vacuum gauge installed on the test port.

4. Press **Done** to leave the screen and return to the previous menu.

3.1.8 Maintenance

- Press **Maintenance** on the Set-Up screen and the Maintenance screen appears (Figure 3-14).

Use this screen to configure:

- The **PASSWORD** and to turn that feature ON or OFF (Software revisions 3.10 and earlier).
- Section 3.1.8.1 “Turbo Vent” on page 3-20
- Section 3.1.8.2 “Date & Time Set-Up” on page 3-21
- Section 3.1.8.3 “Internal Calibrated Leak” on page 3-22

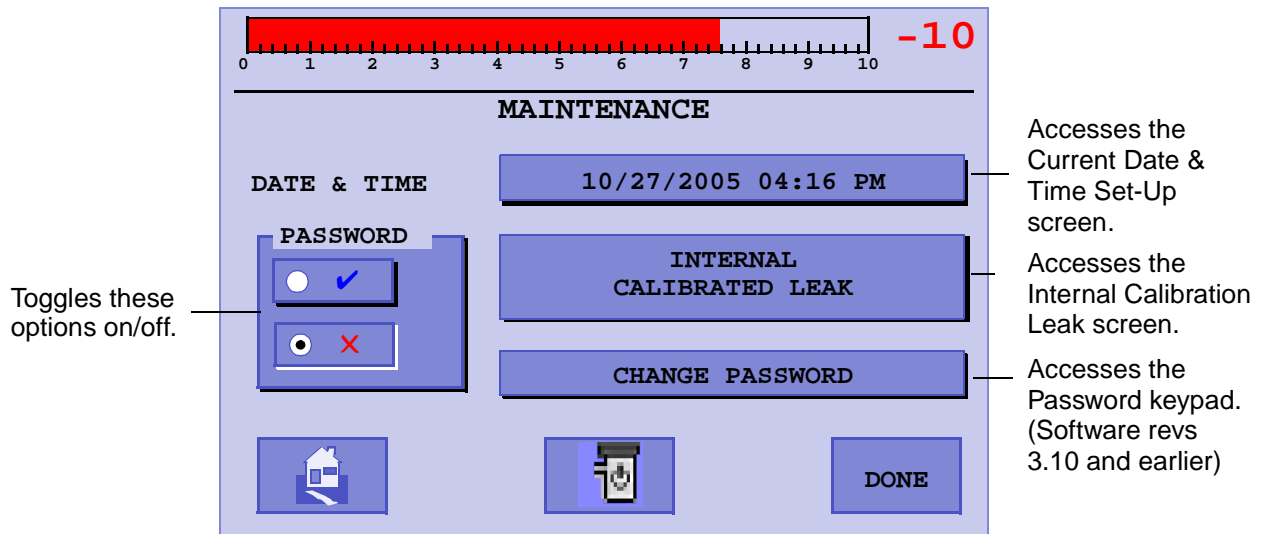

Figure 3-14 Maintenance

- | | |
|-----------------|--|
| Password | Activates/deactivates the password function. When activated, pressing Maintenance from the Menu screen opens the password prompt screen. |
| Change Password | Changes the password used to access the Set-Up and Maintenance screens. Enter up to six numeric values for the password and confirm the password selection. An empty entry is not allowed. If no password is entered, the old password is used. The default password from the factory is 777777. You will need this when changing to a new password. |



The password can also be read through the RS-232 port in the event of a lost password. See Table A-1 on page A-5 and Table A-2 on page A-8.

3.1.8.1 Turbo Vent

Selecting the Turbo Vent button prepares the unit for transportation by venting the system and prompting the operator to power down the unit (Figure 3-15). Pressing the Turbo Vent button:

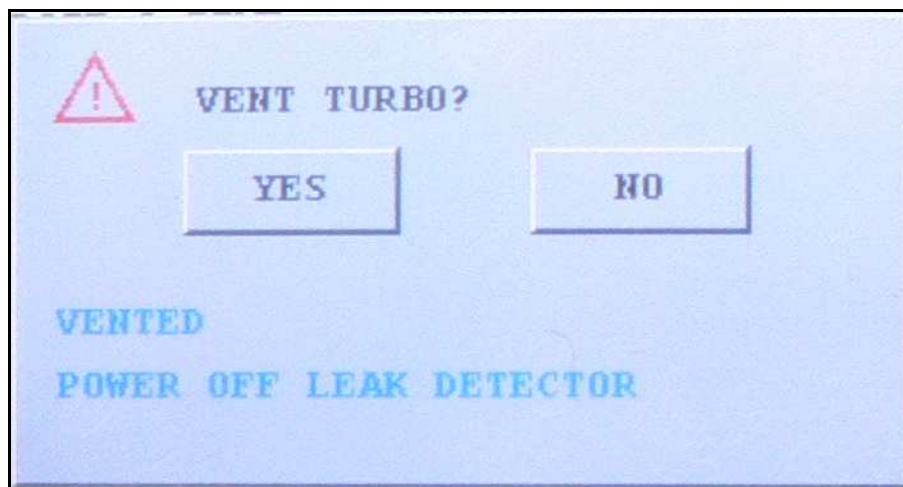

Figure 3-15 Vent Turbo Dialog

1. Closes all the valves.
2. Opens the vent valve.
3. Opens the mid-stage valves.
4. Turns off power to the Ion Source board.

This sequence prevents a pressure burst to the spectrometer and turbo pump so the turbo pump isn't damaged during a move.

3.1.8.2 Date & Time Set-Up

- Press the button next to **Date & Time**.

The Current Date & Time Set-Up screen appears (Figure 3-16).

The screenshot shows a screen titled "CURRENT DATE & TIME SET-UP". At the top, there is a red progress bar with a scale from 0 to 10 and a "-10" indicator. Below the title, there are input fields for YEAR (2005), MONTH (01), DAY (02), DAY OF THE WEEK (MONDAY), 1M/PM/24 (PM), HOUR (04), and MINUTE (30). Navigation buttons include up and down arrows, OK, CANCEL, and DONE.

Figure 3-16 Current Date & Time Set-Up

To configure the Date & Time screen:

1. Press a button to activate its field.
2. Use the Up and Down arrows or keypad to set the value.
3. Press **Done** for each item configured.
4. Repeat step 1 through 3 for each desired item.
5. Press **OK** to exit the screen.

3.1.8.3 Internal Calibrated Leak

- Press **Internal Calibrated Leak**.

The Internal Calibrated Leak screen appears (Figure 3-17).

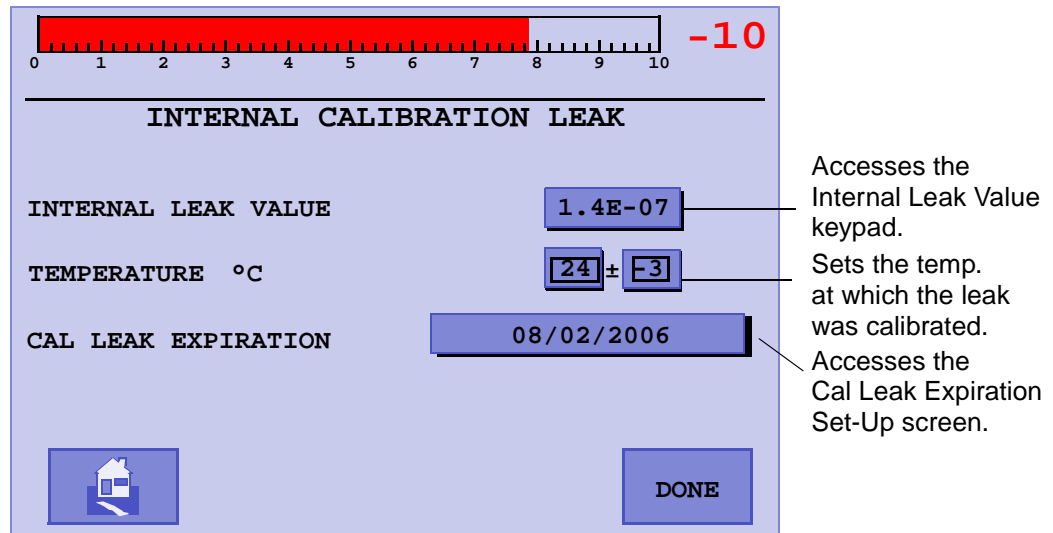

Figure 3-17 Internal Calibrated Leak

To use this screen:

1. Press a button to activate its field.
A keypad appears.
2. Enter the required values as shown on the calibrated leak label.
3. Repeat step 1 and 2 for each desired item.
4. Press **Done** to exit the screen.

The value of the internal calibrated leak, as shown on the CALIBRATION SET-UP and CONTROL PANEL screens, is compensated for temperature using the calibrated leak temperature sensor. The calibrated leak is not compensated for temperature if any of the following conditions exist:

- The temperature sensor on the calibrated leak fails or there is a cable connection problem.
- The temperature sensor reading is out of the operating range. The operating temperature range is from 10.0 to 45.0° C (50 to 113° F).
- The internal calibrated leak is not a E-7 or E-8 range leak.

3.1.8.3.1 Cal Leak Expiration Set-Up

- Press the button next to the *Cal Leak Expiration* text on the Internal Calibrated Leak screen.

The Cal Leak Expiration Set-Up screen appears (Figure 3-18).

The Cal Leak Expiration is usually one year from leak installation. When the calibrated leak expires, a message appears on the Home screen.

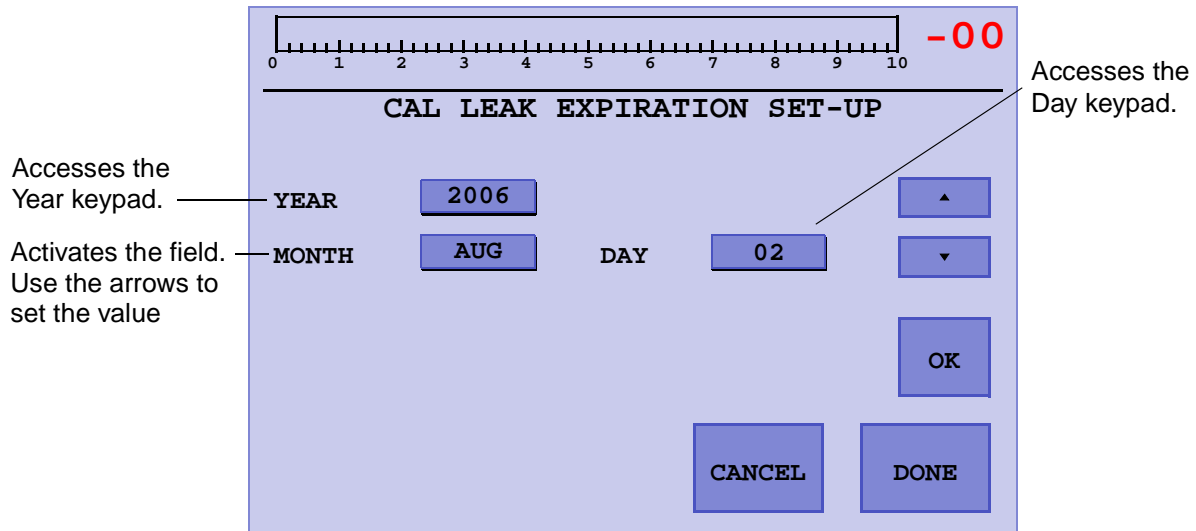

Figure 3-18 Cal Leak Expiration Set-Up

To use this screen:

1. Press the button next to *Year* or *Month* and a keypad appears to set the value.
2. Press **Done** for each item configured.
3. Press the button next to *Day*, use the up and down arrows to set the value and press **Done**.
4. Press **OK** to exit the screen.

3.1.9 Password

This starts with software revision 3.11.

- Password On/Off
- Password Level Selection
- Change Password



Figure 3-19 Password Screen

There are 3 password levels:

- | | |
|-----------|---|
| Level I | Requires a password entry to gain access to SET-UP screens when password protection is enabled. This is same protection as previous software (Software 3.10 and prior). |
| Level II | Requires a password entry to gain access to MENU screens when password protection is enabled. |
| Level III | Locks out the LCD. A password entry is required to gain access all screens behind the HOME screen (Control Panel, Zero & Menus). |



VENT & TEST buttons are still accessible in all password levels.

For Change Password functionality see Section 3.1.8 “Maintenance” on page 3-19.

3.1.10 Fore Pump Set-Up and Exhaust Pump

- Press **Fore Pump** on the Maintenance screen.

The Fore Pump Set-Up screen appears (Figure 3-20). Use this screen to select fore pump speed and type.

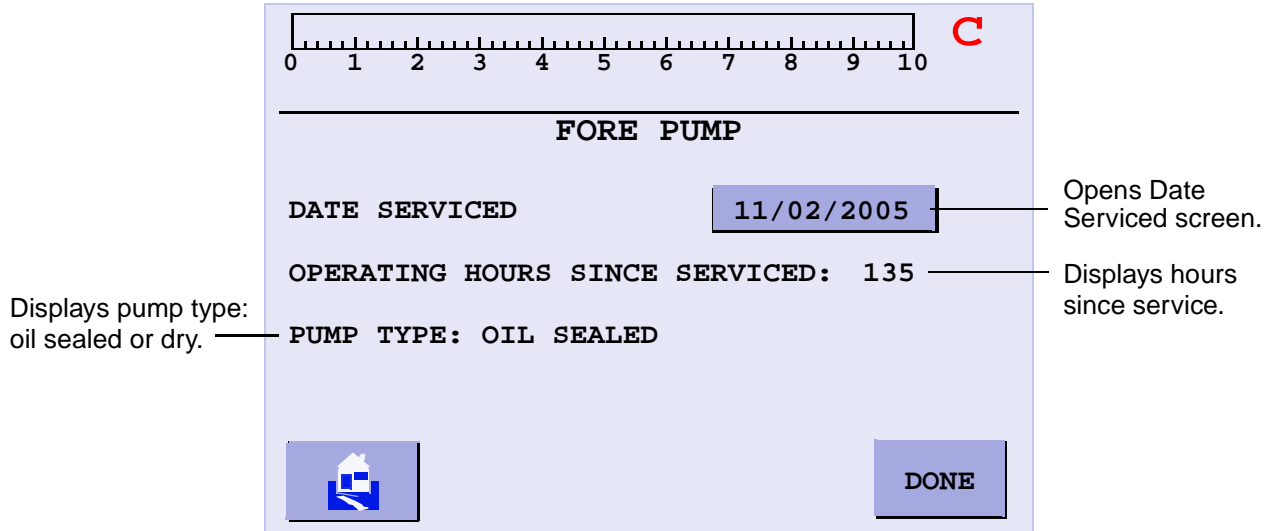

Figure 3-20 Fore Pump Set-Up

Date Serviced

Opens the Section 3.1.10.1 “Date Serviced” on page 3-26. You can also select the date on which the oil is changed or the tip seal is replaced. The system then tracks the operating hours since the pump was last serviced.

3.1.10.3.1 Exhaust Pump Screen (PD03 only)

This screen appears for PD03 operations and only the service date is changeable (Figure 3-21).

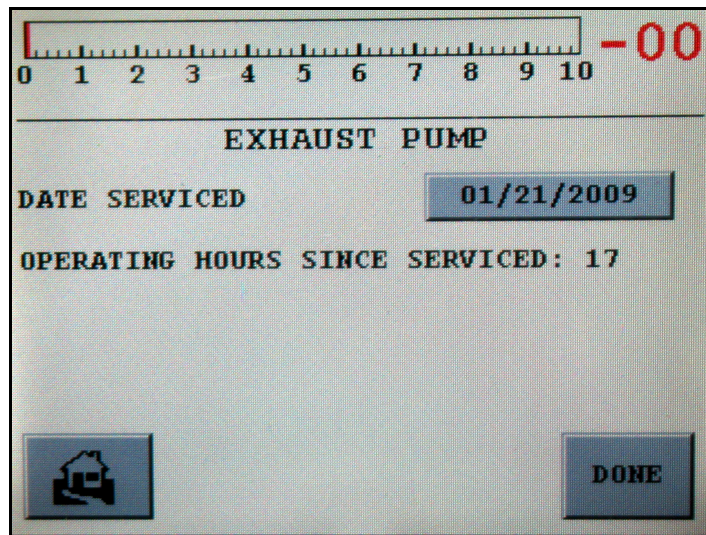

Figure 3-21 Exhaust Pump

3.1.10.1 Date Serviced

- Press the date on the Fore Pump screen and the Date Serviced screen appears (Figure 3-22).

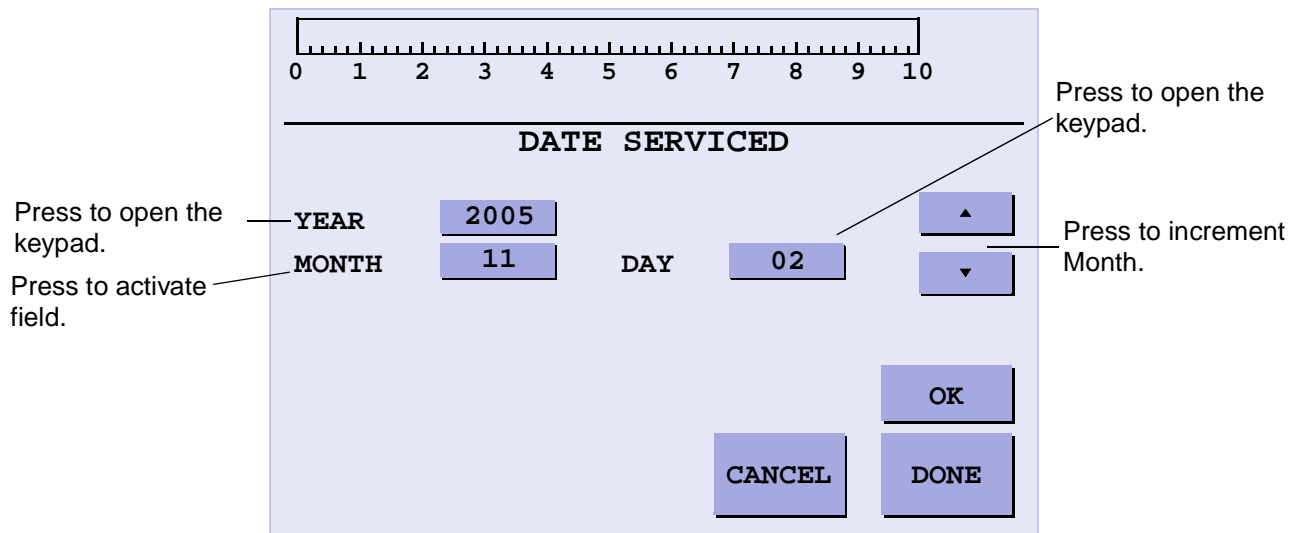

Figure 3-22 Date Serviced

To use this screen:

1. Press the button next to *Year* or *Day* and a keypad appears to set the value.
2. Press **Done** for each item configured.
3. Press the button next to *Month*, use the up and down arrows to set the value and press **Done**.
4. Press **OK** to exit the screen.

3.1.11 Wireless

When the wireless option is installed into the leak detector, a wireless icon button appears on the Maintenance screen.

- ❑ Press the Wireless icon  on the **Maintenance** screen and the wireless screen appears (Figure 3-23).

Use this screen to assign the RF channel that the remote handheld device uses for:

- ❑ Communications with the leak detector,
- ❑ Control of the leak detector
- ❑ And to get other information relating to wireless communications.

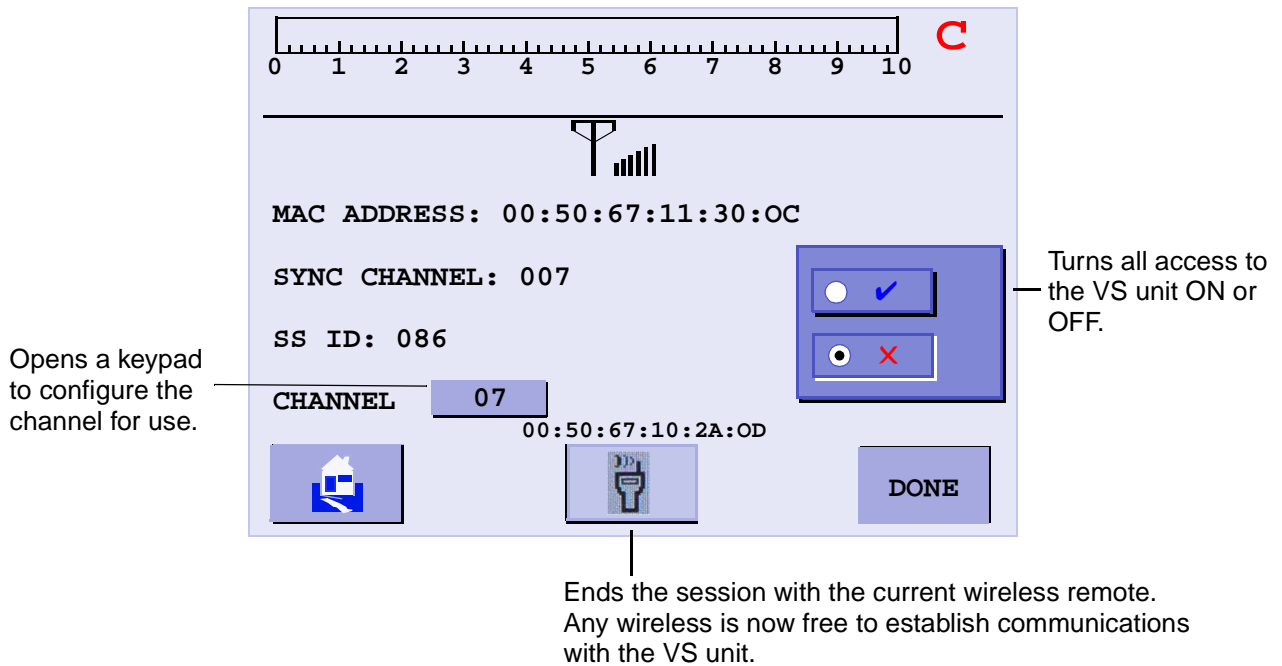

Figure 3-23 Wireless

MAC Address	Two MAC addresses appear on this screen: <ul style="list-style-type: none"> ❑ The MAC address at the top of the screen is the leak detector MAC address. ❑ The MAC address above the hand held button is the MAC address of the hand held device.
SYNC Channel	For informational and factory debug purposes only.
SS ID	Displays the SS ID number, factory set to 086, for informational and factory debug purposes only.

VS Series Helium Mass Spectrometer Leak Detectors

Channel

Click the button and a keypad appears to configure the channel (1-19) that the VS unit uses to communicate with the wireless remote. Up to 10 wireless remotes and leak detectors can be communicating in a common area at a time.

3.1.12 System Defaults

Use this screen to restore system defaults.

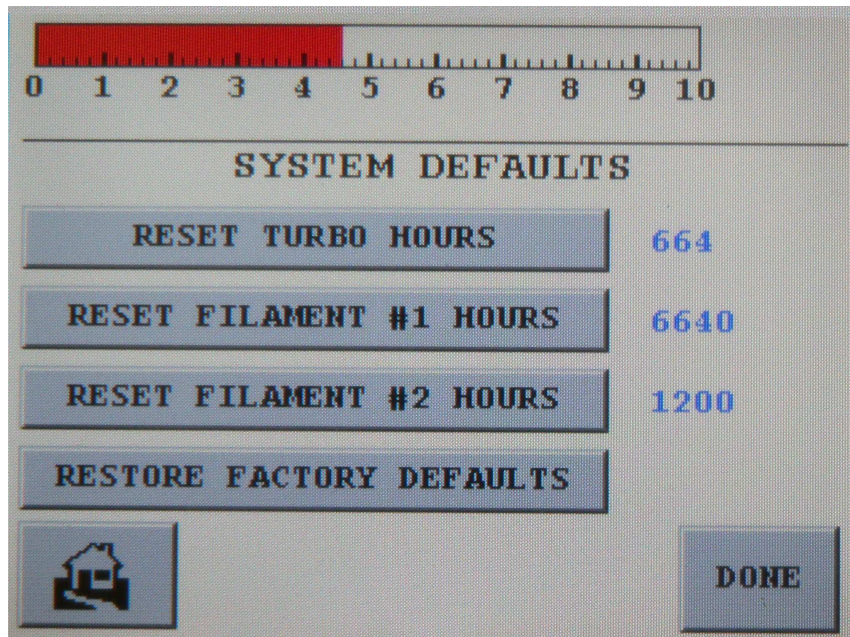

Figure 3-24 System Defaults Screen

Restore System Defaults:

This feature allows for resetting the system back to the original factory configurations:

- Resets Reject Setpoints
- Range Stop
- Top Range & original V-gain
- Auto Zero <0 - Inactive
- Internal calibrated leak information - default condition (re-input)



English for language for the display.

CPU Software Revision 3.10 (August 2010):

- Auto Zero<0 - Active
- Internal calibrated leak rate information will be retained
- V-gain value as shipped will be retained

This page intentionally left blank.

Section 4. Maintenance



All service must be performed by trained personnel only.

A mass spectrometer leak detector requires periodic maintenance to ensure continued reliable operation. After prolonged use, the leak detector accumulates contaminants from even the cleanest of products tested that eventually impair operation. A thorough disassembly and cleaning of the entire vacuum system, which includes the valve block and spectrometer, restores normal operation. For heavy production use, more frequent overhauls may be needed. In most cases, maintenance personnel do this work, but Varian can also do this work under the terms of a service contract.

This maintenance section covers daily and as-required maintenance. It does not cover overhaul of the entire vacuum system. If your leak detector requires service that is not covered in this section, contact Varian Customer Service. See the back cover of this manual for a listing of our sales and service offices.

Important Reminders

In addition to the safety notes at the beginning of this manual, heed the following notes, cautions, and warnings when performing maintenance.

WARNING



Disconnect power from the leak detector before performing any maintenance procedure that requires physically disconnecting any part of the system.

The VS Series leak detector has a battery backed clock which uses a primary (non-rechargeable) lithium coin battery from Panasonic, P/N BR2477A/HB (3.0V, 1Ah) that is permanently soldered onto a Motherboard PCB. Never replace this battery with a rechargeable type. Use only the primary type of lithium battery. Only a qualified technician should replace any battery. The battery has a life of 7 to 10 years.

The VS Series leak detector uses fuses and circuit breakers that are not operator replaceable. Only a qualified technician should replace any fuse.

Information about the fuses and circuit breakers is given in Table 4-3 on page 4-4.

VS Series Helium Mass Spectrometer Leak Detectors

Cleanliness is vital when servicing the leak detector or any vacuum equipment. There are some techniques more important in leak detector servicing than in general vacuum work:

CAUTION



Do not use silicone oil or silicone grease.

Use powder-free butyl or polycarbonate gloves to prevent skin oils from getting on vacuum surfaces.

Do not clean any aluminum parts with Alconox®. Alconox is not compatible with aluminum and will cause damage.

NOTE



Varian does not recommend the use of vacuum grease. Vacuum grease absorbs helium tracer gas and releases this slowly resulting in helium background during leak test operations. If it must be used, use it sparingly and avoid silicone types. Apiezon® L grease is recommended (Varian Part No. 695400004).

When removing, checking or replacing O-rings:

CAUTION



Remove O-rings carefully with your fingers. Do not use metal tools for this task. This prevents scratching of any sealing surfaces.

Wipe all O-rings clean with a lint-free cloth before installation to ensure that no foreign matter is present to impair the seal.

Do not use grease or any other substances on O-rings or metal seals that will come in contact with the spectrometer.

Do not use alcohol, methanol or other solvents on O-rings as this causes deterioration and reduces their ability to hold a vacuum.

NOTE



If applicable, apply a small amount of Apiezon® L grease and wipe the O-rings shiny dry.

NOTE



Due to the effective cleaning nature of VacuSolv solvent and its residue-free properties, Varian' Component and Spectrometer Cleaning Kit (Part Number 670029096), used in accordance with the kit instructions, is recommended for cleaning spectrometer components. The kit can also be used for fine cleaning of other parts in the leak detector's vacuum system such as valves and fittings. No rinsing steps or high-temperature drying are required following cleaning with VacuSolv. Although appropriate precautions are advised, VacuSolv is compatible with most materials and does not contain toxic chemicals or CFCs (chlorofluorocarbons). Other acceptable solvents are isopropyl alcohol (IPA) or Dow Corning® OS-20.

VS Series Helium Mass Spectrometer Leak Detectors

For simplicity, the maintenance functions in this section are grouped by recommended frequency, as shown in Table 4-1, based on assumed daily use.

Table 4-1 Scheduled Maintenance

Description	Daily	12 Months	24 Months
Calibration check	X		
Recalibrate the internal calibrated leak		X	
Replace diaphragm on DP pump (PD03 only)		X	
Replace tip seals on IDP-3 pump (PD03 only)			X

Maintenance functions that may be required on a demand basis, such as changing a filament after filament failure, are listed in Table 4-2.

Table 4-2 As-Required Maintenance

Function	Most Common Symptom
Spectrometer cleaning	The spectrometer is designed to operate for years without maintenance, however actual performance depends on the leak detector operational environment. Spectrometer cleaning restores optimum performance if the unit shows significant sensitivity loss or high background signal. Sensitivity loss appears as a high gain value after a calibration or failure to calibrate with a <i>gain too high</i> error message.
Filament replacement	Filaments are designed to operate for several years with no maintenance. When a filament burns out, the system automatically switches to the other filament and notifies you to recalibrate. The calibration notice also serves to inform you of a filament failure. Varian recommends that the burned out filament be replaced at a convenient time so that a spare is always available during leak test operations to prevent unplanned system down time.
Tuning adjustments	If calibration is not successful or if the system is calibrated to an external leak, tuning can maximize the helium signal.
Mechanical pump fluid change	Persistent, high helium background signal. Fluid contamination (dirty brown color indicates burnt or contaminated fluid, milky white consistency indicates high water vapor content in fluid).

VS Series Helium Mass Spectrometer Leak Detectors



Always perform a Full Internal Calibration after any spectrometer maintenance:

- Spectrometer header replacement*
- Filament replacement*
- Ion source assembly replacement or cleaning*

Table 4-3 lists the fuses and circuit breakers.

Table 4-3 Fuses and Circuit Breakers

Function	Type, MFG, PIN	Location
Circuit Breaker	<input type="checkbox"/> Main Power Supply: 20 A, 250 V AC, SCHURTER Model EF12, PIN EF12.2196.1110.01	Power Entry Module
	<input type="checkbox"/> Internal Vacuum Pump: 6 A, 250 V E-T-A, PIN 1110-FI12-PIMI-6 A	Rear Panel
Fuses (PCB overcurrent protection)	1.85 A, 33 VDC, Raychem SMD185-2	<input type="checkbox"/> Motherboard (RT400) <input type="checkbox"/> Valve Driver (FI) <input type="checkbox"/> Ion Source (FI) <input type="checkbox"/> Front Panel Controller (RT400)
	5x20mm, T4A, 4A, 250V AC, Cooper/Bussmann S505-4A	Turbo Controller (F2)



Only a qualified technician should replace circuit breakers and fuses. Use only circuit breakers and fuses of the same type and rating.

4.1 Daily Maintenance

4.1.1 Sensitivity Check

To perform a sensitivity check:

1. Turn on the Std Leak in the Control Panel screen.
2. Compare the value on the Home screen to the value of the known calibrated leak on the Internal Calibrated Leak screen.
3. If the values do not match, press **Calibrate** on the Control Panel screen to perform an automated calibration and then repeat step 1.

If specification is still not met, Manual Tuning may be required. See Section 3.1.2 “Manual Tuning” on page 3-7.

4.2 Dry Nitrogen Vent

You may want to vent the leak detector test port with dry nitrogen when the system is vented. Venting with dry nitrogen can be helpful in very humid environments to keep the test port as dry as possible which reduces the time required to pump down the system.

NOTE



The nitrogen supply line should have a pressure relief valve installed so that the pressure does not exceed two psi.

NOTE



There are two nitrogen kits available: factory installed kit (P/N# VSFACN2V) and field installed kit (P/N# VSFLDN2V). Detailed installation instructions are included in the field installation kit.

4.3 Spare Parts List

Table 4-4 Leak Detector Spare Parts

Assembly	Part Number
Motherboard PCB	R2101501
CPU PCB	R2361303
Ion Source PCB	R2120501
Valve Driver PCB	R2104502
Exchange Turbo Pump Controller PCB	EX9699518M001
Front Panel Assembly	R2926301
Spectrometer Assembly, Exchange	EXR2040301
Spectrometer Header Ass'y, Exchange	EXVSFLDHHA
Ion Source Replacement Kit	EXVSFLDHIS
Filament Replacement Kit*	VSFLDFR, EXVSFLDHFR
Ion Box Replacement Kit	VSFLDIB, VSFLDHIB
Metal Gasket Kit	VSFLDMG
Valve Block O-ring Kit	VSFLDOV
Calibrated Leak, VS Internal	VSFLDCL
TC Gauge	R3391301
Fan Assembly	VSFLDFN
Power Supply	VSFLDPS
Spec Tube Cleaning Kit	670029096
Fan, IDP3 Pump	VSFLDFN3
Back to Air, Maintenance Kit (V9) PD03 & PR02 (April 2010)	VSFLDV9
PD03 Exhaust Valve, V8, Maintenance Kit	VSFLDV8
Turbo Pump, Exchange	EX8699367
Valve (V1 to V5, V7)	R2010302
V6 Calibrated Leak Valve (prior to April 2010), DS42 Gas Ballast Valve (PR02)	R2011302
V6 Calibrated Leak Valve (April 2010)	612229214

VS Series Helium Mass Spectrometer Leak Detectors

Table 4-4 Leak Detector Spare Parts (Continued)

* VS units sold after 18 Aug 2009 with serial number ST0908L012 or higher use filament kit VSFLDHFR

Primary Pumps	VS Model Number	Part Number
DS302, Exchange	MR15, BR15	EX9699325
DS302 Minor Maintenance Kit	MR15, BR15	9499370
TriScroll 620, Exchange Module	MD30, BD30	EXPTS0620SC
TriScroll 620, Exchange Pump	MD30, BD31	EXPTS06201ULD
TriScroll 620 Tip Seal Kit	MD30, BD32	PTSS0600TS
DS42 Rotary Vane Pump, 120 V, Exchange	PR02	EX9499308
DS42 Rotary Vane Pump, 220 V, Exchange	PR02	EX9499309
IDP-3 Exchange Pump 220 V	PD03	EXIDP3A41
IDP-3 Exchange Pump 120 V	PD03	EXIDP3B41
IDP-3 Exchange Pump 100 V	PD03	EXIDP3C41
IDP-3 Tip Seal Kit	PD03	IDP3TS
Diaphragm Pump Maintenance Kit	PD03	VSFLDDP
Diaphragm Pump Replacement Kit	PD03	VSFLDDPR
Elite Z Mechanical Pump Oil	MR15, BR15, PR02	695409005

4.4 Leak Detector Accessory Item List

Table 4-5 Leak Detector Accessory Item List

Assembly	Part Number
Flapper Box, NW25 Flange	VSFLDFBNW25
Flapper Box, Cable (I/O option required)	VSFLDFBCBL
Power Probe, 10' (NW25 Flange)	K9565306
Power Probe, 25' (NW25 Flange)	K9565307
Spare Tip Filters for Power Probe (Qty: 10)	K9565303
Throttle Valve (NW25 Flange)	R1947301
Calibrated Leak, 10^{-5} , 10^{-6} (NW25 Flange)	F84733205
Calibrated Leak, 10^{-7} (NW25 Flange)	F8473321
Calibrated Leak, 10^{-8} (NW25 Flange)	F8473322
Calibrated Leak, 10^{-9} (NW25 Flange)	F8473323
Calibrated Leak, 10^{-10} (NW25 Flange)	F8473324
Oil Mist Eliminator (PR02)	VSFLDME
Filter, Oil Mist Eliminator (PR02)	649071021
1-1/8" Compression Test Port	VSFLDCP
Handheld Wireless Remote Unit	VSLDWRC
I/O Assembly, Field Installed	VSFLDIO
Wireless Remote Base Unit, Field Installed	VSFLDWB
N ₂ Vent Kit	VSFLDN2V

Appendix A. Communications Protocol

This appendix defines the technical specifications for the RS-232 protocol used with the leak detector and describes the customer-configured inputs/outputs.

A.1 Protocol (RS-232)

RS-232 ports operate at 9600 baud, 8 bits, no parity, and one stop bit.

All characters transmitted to the leak detector are echoed by the leak detector. Commands, inquiries, and strings of both commands and inquiries must be terminated by a carriage return <CR>; the carriage return is echoed as a space character.

The maximum length of the input is 80 characters; if no carriage return has been received before the 80th character, execution of the command string begins anyway.

Words that begin with:

- ❑ **?** are inquiries for the controlling device to determine the current state or value of a leak detector parameter.
- ❑ **PUT-** are commands for the controlling device to set the current state or value of a volatile leak detector parameter.
- ❑ **INIT-** are commands for the controlling device to set non-volatile leak detector parameters.

Other commands do not require a parameter and do not begin with any special characters.

Successful inquiries respond with data, followed by a space, then: **ok**<CR><LF>, as specified in the tables of this appendix. Unsuccessful inquiries respond with the offending inquiry followed by a space, then: **#?**<CR><LF> (line feed, <LF>).

Inquiries, parameters, and commands can be concatenated. Each word or numeric parameter is followed by one or more spaces. The string is terminated by a <CR>, which causes execution to begin.

Successful strings respond with the specified data for the input inquiries in the order the inquiries were issued, followed by: **ok**<CR><LF>.

Unsuccessful strings respond with the *first* offending command followed by a space, then: **#?**<CR><LF>. All commands and inquiries following the failed word are ignored; all parameters are discarded.

Table A-1 on page A-5, Table A-2 on page A-8, Table A-3 on page A-11, and Table A-4 on page A-11 outline the available control and query commands.

A.2 Communicating with RS-232

The RS-232 Protocol is intended for diagnostic purposes and initial set-up inquiries. The RS-232 connection is located on the rear D-sub 9-pin connector.

The leak detector RS-232 port is not an interrupt-driven port. It is configured as DTE (Data Terminal Equipment), therefore the leak detector's RS-232 Protocol cannot be sent as strings.



When programming with virtual instrumentation programs such as LabView, TestPoint, or Visual Basic, try one the following two methods:

- Transmit the intended command one character at a time with a minimal delay time of 50 milliseconds between each character. Terminate the command with a carriage return (CR).
- Transmit the intended command one character at a time. Wait for an echoed response from the leak detector before transmitting the next character. Terminate the command with a carriage return (CR)

Windows 95 and later versions contain a serial communications program called HyperTerminal, a useful tool in establishing communication between the leak detector and a PC.

A.2.1 Windows HyperTerminal Set-Up Instructions

To set up Windows HyperTerminal:

1. Click **Start**.
2. Select *Programs > Accessories > Communications > HyperTerminal*.
3. Double-click **Hypertrm.exe**.
The Connection Description dialog box appears.
4. Enter a name and choose an icon for the connection, for example: leak detector RS-232.
5. Click **OK**.
The Connect To dialog box appears.
6. Select a COM port from the *Connect Using*: the pull-down list.
The Com Properties/Port Setting dialog box appears.

7. Configure the following settings:
 - Bits per second (baud rate) – **9600**
 - Data bits: – **8**
 - Parity: – **None**
 - Stop bits: – **1**
 - Flow Control: – **None**
8. Click **OK**.
9. Select **Properties** from the File menu.

The Properties window appears.
10. Configure the following settings on the Connect To tab:
 - Connect using – Verify the COM port is correct.
 - Click **Configure** and verify the port settings are correct.
11. Ensure that the Settings tab is configured as follows:
 - Terminal keys radio button selected.
 - Ctrl+H radio button selected.
 - Auto detect selected from the Emulation pull-down list.
 - ANSI entered in the Telnet terminal ID.
 - 500 set in the Background buffer lines field.
12. Click **ASCII Set-Up**.

The ASCII Set-Up dialog box appears.
13. Ensure that the settings are as follows:
 - Line delay – **0 milliseconds**
 - Character delay – **0 milliseconds**
 - ASCII Receiving – **Wrap lines that exceed terminal width**

The cursor begins blinking.
14. Type some simple commands:
 - ?LEAK
 - ?ALL
 - ?SETUP

A.2.2 Printing with HyperTerminal

The easiest way to print information captured in HyperTerminal is to choose Print from the File menu; however, this method only prints information currently displayed on the screen. Screen information can also be highlighted, copied and pasted into Microsoft Word or Excel.

To capture large amounts of data that exceeds the terminal screen limits, use the Transfer menu Capture Text option:

1. Select *Transfer > Capture text*.
The Capture text dialog box appears.
2. Click **Browse**.
The Select Capture File dialog box appears.
3. Navigate to a location, enter a file name and select a file type:
 - .txt text file (Notepad)
 - .doc (Word)
 - .xls (Excel)
4. Click **Save**.
The Capture Text dialog box reappears.
5. Click **Start** to log data.
6. Select *Transfer > Capture Text > Stop* to end text capture.
7. Open the file where the data was stored and select *File > Print*.

Example

To use the above procedures to poll the leak detector leak rate using HyperTerminal and capture the text:

1. Type the command: **XYZZY**.
If received correctly, the leak detector responds *ok*.
2. Type the command: **?LEAK 1 SECS CR ?ESC**.
This command polls the leak rate every second. The time is set in seconds.
3. Press **ESC** to abort polling.
4. Select *Transfer > Capture Text*.
5. Browse to a folder and file using the Capture Text dialog box and click **Start**.
6. Select *Transfer > Capture Text > Stop* to abort data logging.

VS Series Helium Mass Spectrometer Leak Detectors

Table A-1 lists inquiries that are used to determine internal operating parameters. All inquiries, except VER, begin with ? and end with <CR>.

Table A-1 Internal Operating Parameters

Inquiry	Response
?ALL	Responds with four lines. Each begins with a <cr><lf>. The first line reports the ion chamber value. The second line reports the emission value. The third line reports the value of the offset variable. The fourth line reports the gain value.
?AZ<0	Reports the status of the Auto-zero < 0 function, ON or OFF.
?CALOK	Reports the status of the last calibration.
?CL-XFER	Reports the currently stored contra-flow mode crossover pressure.
?CPLOCKOUT	Reports the status of the control panel lockout feature, ON or OFF.
?CURRDATE	Reports the current system date and time in the following format: 3 05/25/2005 04:19:03.35 1 where 3 is the day of the week (0 = Sunday, 1 = Monday, etc), 05/25/2005 is mm/dd/yyyy (date), 04:19:03.35 is hh/mm/ss/ms (time) and 1 is PM (0=AM, 1=PM, 2=24 hour).
?DISPLAY	Reports what the display bar graph is set to, <i>log</i> or <i>lin</i> .
?EMISSION	Reports the emission value.
?EXPONENT	Reports the current manual-mode exponent with a two-character (minus followed by one digit) number. The exponent is within the least sensitive range (as reported by ?RANGE) and the three lower (more negative exponent) ranges. See also INIT-EXPONENT.
?EXTLEAK	Reports the currently stored value of the external standard leak.
?GAIN	Reports the system gain value by returning a three-character number consisting of a two-digit gain factor with a decimal point after the first digit.
?INTEXT	Indicates which leak, Internal or External has been selected for use during calibration.
?I/O BOARD	Returns the status: 0 = not installed, 1 = installed
?IO_VER	Returns the software revision of the installed I/O PCB
?IONCHAMBER	Reports the ion chamber value.
?LANGUAGE	Reports the language that has been selected to display on the front panel (0=English, 1=French, 2=German, 3=Korean, 4=Spanish, 5=Japanese, 6=Chinese).

VS Series Helium Mass Spectrometer Leak Detectors

Table A-1 Internal Operating Parameters (Continued)

Inquiry	Response
?LEAK	Reports a six-character number consisting of a two-digit leak rate mantissa with decimal point after the first digit followed by E - then a two digit number, which is the leak rate range exponent (e.g., 1.3E-08).
?LKEXP	Reports the internal calibrated leak expiration date mm/dd/yyyy.
?LEAKTEMP	Reports the internal calibrated leak temperature that the factory calibration was performed at (degrees C).
?LP	Reports the current leak rate along with the test port and system pressures.
?LPV	Reports the current Leak Rate, Pressures and Valve state.
?ML-XFER	Reports the current contra to midstage crossover pressure setpoint in Torr. The response is in exponential format (in Torr): X.XE-XX
?PREHEAT	Command to query if the preheat ion source PCB is installed A response of 0 = No, 1 = Yes
?PREHEAT-TIME	A numerical response in minutes.
?PRESSURES	Reports two lines. Each begins with a <cr><lf>. The first line consists of the words <i>test port TC</i> followed by a number in mTorr. The second line consists of the words <i>system TC</i> followed by a number in uTorr.
?PWDLEVEL	Response will be a number (1, 2 or 3).
?PWDONOFF	Reports status of system password (ON or OFF).
?QUICK-CAL	Reports whether Fast or Full Calibration is chosen if a calibration were to be started.
?RANGESTOP	Reports the value of the Range Stop variable.
?REJECT	Reports the reject leak rate setpoint (e.g., 7.0E-05) (where x is a number from 1 to 4 or the letter A).
?>xREJECT	Reports the status of a reject set point (where x is a number from 1 to 4 or the letter A).
?xREJECT	Reports the reject leak rate setpoint (e.g., 7.0E-05) (where x is a number from 1 to 4 or the letter A).
?ROUGH	Reports the currently stored Test Sequencer rough time used as part of setting up the Auto Sequencer.
?RSONOFF	Reports the status of the Rangestop function as Enabled or Disabled.
?SEQONOFF	Reports the status of the Auto Sequencer as Enabled or Disabled.

VS Series Helium Mass Spectrometer Leak Detectors

Table A-1 Internal Operating Parameters (Continued)

Inquiry	Response
?SETUP	Reports seven lines, each begins with a <cr><lf>. The first line reports the turbo pump speed with the RPM value or OFF. The second line reports the selected manual leak rate range, and the ranging method as auto or manual. The third line reports the least sensitive leak rate range. The fourth line reports the reject set point leak rate. The fifth line reports the internal calibrated leak rate value. The sixth line reports the DAC output method as Linear, Log(2V), or Log(3V). The seventh line reports the active filament status as <i>One</i> or <i>Two</i> , followed by <i>Lit</i> or <i>Out</i> .
?SPLITFLOW	Returns the status of the split flow function, ON or OFF.
?STDLEAK	Reports a six-character number consisting of a two-digit calibration standard leak rate mantissa with a decimal point after the first digit followed by <i>E-</i> , and then by a two-digit exponent (e.g., 1.3E-07). This inquiry is used for reporting the calibration standard leak rate entered using INIT-STDLEAK.
?SYSLEAK	Reports the leak rate value that has been stored that relates to the split flow functionality.
?SYSPWD	Reports the value of the system password.
?TEST	Reports the currently stored Test Sequencer test time used as part of setting up the Auto Sequencer.
?TEMPFACTOR	Reports the internal calibrated leak temperature factor that is used as part of the temperature correction logic (degrees C).
?TURBO	Reports four lines, each begins with a <cr><lf>. The first line consists of the word <i>turbo</i> followed by either READY or NOT READY. The second line consists of the word <i>turbo</i> followed by either <i>Fault</i> or <i>No Fault</i> . The third line consists of the words <i>turbo speed RPM</i> followed by the RPM value: xxxxx. The fourth line consists of the words "Turbo Temp (Celsius):" followed by the bearing temperature value: XX.
?VALVESTATE	Reports the current mode of the valves: Vent, Hold, etc.
VER	Reports the CPU software version in the form LC02.05 followed by a six digit hexadecimal checksum.
?VOLUMEONOFF	Reports audio as either ON or OFF.
WHYNOCAL	Reports the calibration failure diagnostics.
?0ENABLE	Responds with the status of the <i>Zero Enable</i> function, ON or OFF.

VS Series Helium Mass Spectrometer Leak Detectors

The commands listed in Table A-2 are used to set *non-volatile* operating parameters. The current value of the operating parameter is changed to the new value. If the leak detector is in back panel control, the response is *cant*.

Table A-2 Non-Volatile Operating Parameters

Command	Parameter
INIT-AZ<0	Preceded by 0 or 1, sets the status of Auto-zero < 0. 0 = off, 1 = on.
INIT-CL-XFER	Preceded by <i>X.XE-X</i> , sets the value of the contra-flow mode crossover pressure in Torr.
INIT-CPLOCKOUT	Sets the status of the control panel lockout. Preceded by (0) or (1), 0 = OFF, 1 = ON.
INIT-DATE	Sets the system date and time. Preceded by: dow, mm dd yyyy hh mm ss AmPm 24-12 mode, Where 2 is the day of the week (dow) (0 = Sunday, 1 = Monday, etc), mm/dd/yyyy (date), hh:mm:ss (time) AmPm (0=AM, 1=PM)24-12 mode (0 for 24 hr, 1 for 12 hr). Examples: 2 02 12 2005 04 16 33 1 0 INIT-DATE(Tuesday, February 12, 2005, 4:16:33 on a 24 hr clock)2 02 12 2005 04 16 33 1 1 INIT-DATE(Tuesday, February 12, 2005, 4:16:33 PM)?CURRDATE reports the stored value
INIT-DISPLAY	Sets the status of the bar graph display to either a log or linear display. Preceded by (1) Log or (0) Linear.
INIT-EMISSION	Sets the emission of the ion source. Preceded by a three-digit number (micro-amps), in the range 60 to 165.
INIT-EXPONENT	Sets the range that the leak detector will operate in when Manual Range is ON. Preceded by 0 to -11.
INIT-EXTLEAK	Sets the value of the external leak. Preceded by a two-digit leak rate mantissa with a decimal point after the first digit followed by <i>E-</i> , and then by a two-digit leak range exponent: the helium leak rate number in atm cc/sec of the calibration standard leak. Example: 3.2E-08 INIT-EXTLEAK
INIT-FILAMENT	Sets the operating filament in the ion source. Preceded by a single digit, either 1 or 2.
INIT-GAIN	Sets the value of the gain used for adjusting the helium signal to match a calibration standard leak. Preceded by a two-digit number with a decimal point after the first digit, in the range 1.0 to 6.0. Note: Changing Gain changes Zero by the same ratio.

VS Series Helium Mass Spectrometer Leak Detectors

Table A-2 Non-Volatile Operating Parameters (Continued)

Command	Parameter
INIT-ION	Sets the ion voltage of the ion source. Preceded by a three-digit number (volts) in the range 220 to 280.
INIT-LANGUAGE	Selects the language to be shown on the display. Preceded by 0-6 where (0=English, 1=French, 2=German, 3=Korean, 4=Spanish, 5=Japanese, 6=Chinese).
INIT-LINEAR	Sets the leak rate analog output voltage to Linear. Not preceded by a value.
INIT-LKEXPIRE	Sets the date on which the internal calibrated leak expires. Preceded by the date. Example: mm dd yyyy INIT-LKEXPIRE
INIT-LEAKTEMP	Sets the internal calibrated leak temperature (printed on the leak label) that the factory calibration was performed at. Preceded by 12.0 to 50.0 (degrees C). Example: 23.5 INIT-LEAKTEMP
INIT-1LOG	Sets the leak rate analog output voltage to logarithmic at 1 volt per decade. Not preceded by a value.
INIT-ML-XFER	Sets the value of the midstage-flow mode crossover pressure in Torr. Preceded by X.XE-XX. The range is 1.0E-03 to 1.0E-01 Torr. The default is 1.0E-01 (100 mTorr).
INIT-PASSWORD	Sets the system password. Preceded by a 1 to 6 digit password and followed by a digit indicating the number of digits in the password. Example: 123123 6 INIT-PASSWORD. Password is read back using the ?SYSPWD command.
X INIT-PWDLEVEL	X is the password level from 1 to 3.
INIT-QUICK-CAL	Sets which type of calibration will be run if the CALIBRATE command is initiated. Preceded by 0 or 1, 0 for FULL cal, 1 for FAST cal.
INIT-RANGESTOP	Sets the value of the most sensitive range exponent. Preceded by XX.
INIT-1REJECT	Sets the leak rate value for Reject Set Point #1. Preceded by a two-digit leak rate mantissa with a decimal point after the first digit followed by E-, and then by a two-digit leak range exponent, the helium leak rate number is in atm cc/sec. Example 3.4E-08 INIT-1REJECT
INIT-2REJECT	Same as INIT-1REJECT, but for Reject Set Point #2.
INIT-3REJECT	Same as INIT-1REJECT, but for Reject Set Point #3.

VS Series Helium Mass Spectrometer Leak Detectors

Table A-2 Non-Volatile Operating Parameters (Continued)

Command	Parameter
INIT-4REJECT	Sets the test port pressure value for Reject Set Point #4. Preceded by a two-digit leak rate mantissa with a decimal point after the first digit followed by <i>E-</i> , and then by a two-digit exponent: the test port TC pressure in millitorr. Example 1.5E-02 INIT-4REJECT
INIT-AREJECT	Same as INIT-1REJECT, but for the Audio Reject Set Point.
HIGH-xREJECT	Sets the reject set point to activate when the actual test value is higher than the set point. Where x is a number from 1 to 4 or the letter A. For example, the reject set point is set for 7.0E-05 and the actual test value is 9.2E-05.
LOW-xREJECT	Sets the reject set point to activate when the actual test value is lower than the set point. Where x is a number from 1 to 4 or the letter A. For example, the reject set point is set for 7.0E-05 and the actual test value is 4.3E-07.
INIT-ROUGH	Sets the Auto Sequencer rough time in seconds. Preceded by <i>XX</i> .
INIT-SYSLEAK	Sets the split flow leak value, system must be in TEST and the split flow feature must be OFF when this parameter is set. Preceded by a two-digit leak rate mantissa with a decimal point after the first digit followed by <i>E-</i> , and then by a two-digit leak range exponent: the helium leak rate number in atm cc/sec. Example 3.4E-08 INIT-SYSLEAK.
INIT-STDLEAK	Sets the value of the internal leak. Preceded by a two-digit leak rate mantissa with a decimal point after the first digit followed by <i>E-</i> , and then by a two-digit leak range exponent: the helium leak rate number in atm cc/sec. Example: 3.2E-08 INIT-STDLEAK.
INIT-TCTPZERO	Used to calibrate the low-pressure end of the test port thermocouple to a known pressure higher than zero. Preceded by a number (<i>XX</i>) of mTorr representing the test port pressure at the time of the command.
INIT-TEMPFACTOR	Sets the temperature correction factor that is printed on the internal calibrated leak label. Preceded by -10 to +10. Example: -7 INIT-TEMPFACTOR
INIT-TEST	Sets the Auto Sequencer test time in seconds. Preceded by <i>XX</i> .
LOCK-MS	Enables the MS lock feature. If the system exceeds 150 mTorr, the system goes from Fine test directly into Roughing mode (no Contra mode). If the leak rate exceeds the 7 range, the over range symbol appears.

VS Series Helium Mass Spectrometer Leak Detectors

Table A-2 Non-Volatile Operating Parameters (Continued)

Command	Parameter
UNLOCK-MS	Disables the MS lock feature.
?MS-LOCK	Queries the status of the MS lock feature; either <i>on</i> or <i>off</i> appears.

The commands listed in Table A-3 are used to cause an immediate change in the spectrometer operating parameters. *These Commands Do Not Change The Non-Volatile Operating Parameters.*

Table A-3 Spectrometer Operating Parameters

Command	Parameter
PUT-EXPONENT	Sets the exponent leak range for Manual mode. Preceded by a two-character number. Acceptable values are 0 through -10.
PUT-ION	Sets the ion value of the ion source. Preceded by a three-digit number of volts, in the range 200 to 350.
PUT-RANGESTOP	Sets the Range Stop exponent. Preceded by two or three characters -XX or -X.

The commands listed in Table A-4 are used to cause certain leak detection actions.

Table A-4 Leak Detection Actions

Command	Action
AUTO	Initiates auto-ranging mode. Success is indicated by the normal <i>ok</i> response.
CALIBRATE	Initiates a Full or Fast calibration depending on system settings. The CPU software tunes, then adjusts the gain so that the current helium signal causes the current leak rate measurement to be the same as the most recently input using INIT-STDLEAK. If the gain is 2.9 or higher, a normal calibration is performed. Success is indicated by the normal <i>ok</i> response.
DECREMENT	Subtracts 1 from the Manual Ranging leak rate exponent (making it more negative). Success is indicated by the normal <i>ok</i> response. Does nothing in auto-ranging mode. Does nothing upon reaching the most sensitive range.
DISABLE-0ENABLE	Turns the Zero Enable function OFF.
DISABLE-PASSWORD	Turns the password function OFF.
DISABLE-xREJECT	Turns the Reject Set Point OFF. Where x is a number from 1 to 4 or the letter A.

VS Series Helium Mass Spectrometer Leak Detectors

Table A-4 Leak Detection Actions (Continued)

Command	Action
DISABLE-RANGESTOP	Turns the Range Stop function OFF.
DISABLE-SEQUENCER	Turns the auto sequencer function OFF.
DISABLE-SPLIFLOW	Turns the split flow function OFF.
DISABLE-VOLUME	Turns audio OFF.
ENABLE-0ENABLE	Turns the Zero Enable function ON.
ENABLE-PASSWORD	Turns the Password feature ON.
ENABLE-xREJECT	Turns the Reject Set Point ON. Where x is a number from 1 to 4 or the letter A.
ENABLE-RANGESTOP	Turns the Range Stop function ON.
ENABLE-SEQUENCER	Turns the auto sequencer function ON.
ENABLE-SPLITFLOW	Turns the split flow function ON.
ENABLE-VOLUME	Turns audio ON.
EXTERNAL	Sets the External Calibrated Leak (in test port) as the leak for use during calibration.
INCREMENT	Adds 1 to the Manual Ranging leak rate exponent (making it less negative). Success is indicated by the normal <i>ok</i> response. Does nothing in auto-ranging mode. Does nothing upon reaching the least sensitive range.
INTERNAL	Sets the Internal Calibrated Leak as the leak to be used during calibration.
KEEP	Causes the leak detector to close most valves and enter the Hold state.
MANUAL	Turns the Manual Ranging Mode ON. Success is indicated by the normal <i>ok</i> response.
NOSNIFF	Turns the HIGH PRESSURE TEST function OFF.
ROUGH	Causes the leak detector to begin a roughing on the test port only.
SNIFF	Turns the HIGH PRESSURE TEST mode ON.
STDLEAK	Turns Read Std Leak ON/OFF. Verifies calibration by exposing internal cal leak to the system.
TPTCATM	Sets the current test port thermocouple reading to represent atmospheric pressure when the test port is exposed to atmosphere. Success is indicated by the normal <i>ok</i> response.
TPTCZERO	Sets the current test port thermocouple reading to represent a ZERO pressure reading when the test port pressure is less than 1.0E-04 Torr. Success is indicated by the normal <i>ok</i> response.

VS Series Helium Mass Spectrometer Leak Detectors

Table A-4 Leak Detection Actions (Continued)

Command	Action
TUNE	Adjusts the ion source voltage to cause a maximum response to helium.
VENT	Causes the leak detector to isolate and vent the test port to the atmosphere.
XYZZY	Unlocks the system so that all RS-232 commands are accessible.
ZERO	Sets the current leak rate measurement to be 0.0 atm cc/sec in the most sensitive range.

A.3 Customer Accessible Inputs and Outputs

A.3.1 Serial Connector

Use the *SERIAL* connector on the Rear Panel to interface the VS Series leak detector to a PC via an isolated RS-232 connection. Table A-5 and Figure A-1 provide details of the connection. A typical connection from a 9-pin PC serial connector requires a female-to-female, 9-pin, null modem cable, where pins 2 and 3 are crossed.

Table A-5 Serial Connector Summary

Pin	EIA Name	Description
2	Received Data	Data into the leak detector
3	Transmit Data	Data out of the leak detector
5	Signal Common	RS-232 Ground

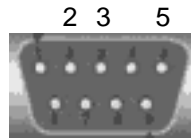

Figure A-1 Serial Connector Map

A.3.2 I/O Connector

Table A-6 lists the optional discrete I/O PCB (P/N# R2111501) pin signals. This I/O connector provides a means for a controller, usually a PLC, to control or to determine the leak detector status. The I/O is accessible via a type DB25S (female socket) connector.

Table A-6 I/O Connector Pin Signals

Pin No.	Signal Name	I/O	Signal	Description	Leak Detector Behavior
15, 19, 23	+ VIN	N/A	+5 V to +24 VDC	Customer-supplied +5VDC to + 24VDC for Output Common pins.	
17, 21	VRET	N/A	0 VDC	Customer -supplied GND for the Input Common pins.	
1	CAL_OUT	O	Level	Active HIGH when the leak detector is in CALIBRATION mode.	Performs calibrating routine with the Internal Calibrated Leak; Zeroing routine is included.

VS Series Helium Mass Spectrometer Leak Detectors

Table A-6 I/O Connector Pin Signals (Continued)

Pin No.	Signal Name	I/O	Signal	Description	Leak Detector Behavior
2	ZERO_OUT	O	Level	Active HIGH when the leak detector is in ZEROING mode.	Performs the Zeroing routine.
3	HOLD_OUT	O	Level	Active HIGH when the leak detector is in HOLD mode.	Performs a HOLD routine and isolates the test port and any test objects from the leak detector vacuum system.
4	VENT_OUT	O	Level	Active HIGH when the leak detector is in VENT mode.	Performs a VENT routine, isolates the test port from the leak detector vacuum system and vents the test port to atmosphere.
5	START_OUT	O	Level	Active HIGH when the leak detector is in START/ROUGH mode.	Performs a ROUGHING routine on the test port and any attached test objects.
6	READY_OUT	O	Level	Active HIGH when the leak detector is in READY mode.	Indicates that the leak detector is completing a STARTING routine and that the filament and turbo are OK.
7	TEST_OUT	O	Level	Active HIGH when the leak detector is in FINE TEST mode.	Indicates that the leak detector is ready for fine leak testing.
8	REJECT1_OUT	O	Level	Active HIGH when the leak rate is over set point #1.	Indicates that the value of the leak rate exceeds the value set in the 1REJECT variable.
9	REJECT2_OUT	O	Level	Active HIGH when the leak rate is over set point #2.	Indicates that the value of the leak rate exceeds the value set in the 2REJECT variable.
10	REJECT3_OUT	O	Level	Active HIGH when the leak rate is over set point #3.	Indicates that the value of the leak rate exceeds the value set in the 3REJECT variable.

VS Series Helium Mass Spectrometer Leak Detectors

Table A-6 I/O Connector Pin Signals (Continued)

Pin No.	Signal Name	I/O	Signal	Description	Leak Detector Behavior
11	REJECT4_OUT	O	Level	Active HIGH when the test port pressure is over set point #4.	Indicates that the value of the test port pressure exceeds the value set in the 4REJECT variable.
12	CAL_OUT_OK	O	Level	Active HIGH when calibration is successful.	Indicates the calibration has successfully completed. Set low on power-up or if calibration is not successfully completed.
13	AUTO_MANUAL_RANGE_IN	I	Level	Active HIGH when Manual Ranging is selected.	Activation causes the leak detector to change from AUTO to MANUAL ranging ; Default is AUTO.
14	CAL_IN	I	> 200 ms Pulse	Active HIGH pulse.	Initiate CALIBRATING routine with Internal Calibrated Leak; Zeroing routine is included.
16	ZERO_IN	I	> 200 ms Pulse	Active HIGH pulse.	Initiate ZEROING routine.
18	HOLD_IN	I	> 200 ms Pulse	Active HIGH pulse.	Initiate HOLD routine and isolate the test port and any test objects from leak detector vacuum system.
20	VENT_IN	I	> 200 ms Pulse	Active HIGH pulse.	Initiate VENT routine and vent the test port to atmosphere.
22	TEST_IN	I	> 200 ms Pulse	Active HIGH pulse.	Initiate ROUGHING routine on the test port and any attached test objects.

VS Series Helium Mass Spectrometer Leak Detectors

Table A-6 I/O Connector Pin Signals (Continued)

Pin No.	Signal Name	I/O	Signal	Description	Leak Detector Behavior
24	RDSTDLK_IN	I	Level	Active HIGH when standard leak is ON.	Initiate the INTERNAL STANDARD LEAK reading routine.
25	PARALLEL_ENABLE_IN	I	Level	Active HIGH when ENABLE is active.	Activation causes the leak detector to take inputs only from the rear panel I/O or RS-232 port. No control functions (inputs) from the front panel or wireless are allowed.

Figure A-2 shows the output circuit sketch. Level outputs are optically isolated emitter followers with 10 Ohm series resistors, and a 14 mA max drive current (24 VDC max).

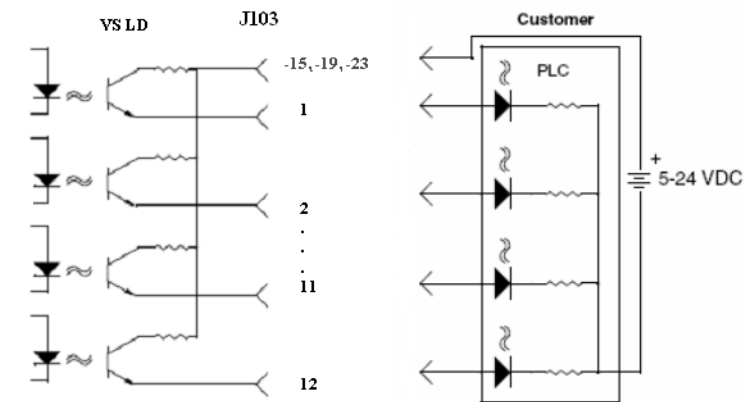

Figure A-2 Optically Isolated Output Circuit Sketch

VS Series Helium Mass Spectrometer Leak Detectors

Figure A-3 shows the input circuit sketch. All inputs are optically isolated 3300 Ohm resistive loads in series with the LEDs of the opto-isolators and voltage level from +5 VDC to +24 VDC. The required pulse inputs are 200 ms minimum pulse width.

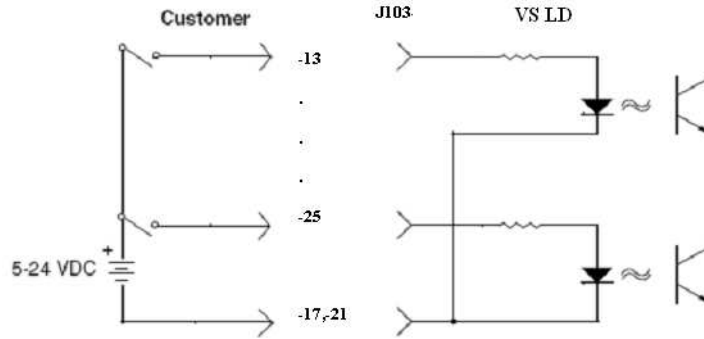

Figure A-3 Optically Isolated Input Circuit Sketch

This page intentionally left blank.

Appendix B. Introduction to Leak Detection

B.1 Leak Testing—Why is it Needed?

Helium is a superior choice of tracer gas used to find leaks for a multitude of reasons. Helium is:

- Non-toxic
- Inert and non-condensable
- Normally not present in the atmosphere at more than trace amounts
- Relatively inexpensive
- Readily passes through leaks due to its small atomic size
- Non-flammable
- Available in various size cylinders
- Available in purities appropriate for medical usage

The only molecule smaller than Helium (mass 4) is Hydrogen (mass 2), which is not inert. Helium is much lighter than the next heavier inert molecule, Neon (mass 20) which is much more expensive. Helium is present at a concentration of only 5 ppm in normal atmospheric conditions.

B.2 Varian's Helium Leak Detection Technologies

A Mass Spectrometer Leak Detector (*MSLD*) is a complete system for locating and/or measuring the size of leaks into or out of a device or a container. This method of leak detection is initiated when a tracer gas, helium, is introduced to a test part that is connected to the MSLD system. The helium leaking from the test part diffuses through the system, its partial pressure is measured, and results are displayed on a meter.

The MSLD operating principle consists of ionization of the gases in a vacuum and their acceleration across a voltage drop and a magnetic field (Figure B-1). The helium ions are separated and collected, and the resulting ion current is amplified and indicated on the meter or display.

A mass spectrometer leak detector consists of the following components:

- A spectrometer tuned to detect the mass of helium
- A vacuum system to maintain adequately low pressure in the spectrometer
- A mechanical pump(s) to evacuate the part to be tested

VS Series Helium Mass Spectrometer Leak Detectors

- ❑ Valves that enable the various stages of the leak detection cycle, from evacuation, to test, to venting
- ❑ Amplifier and readout instrumentation that monitors spectrometer output signal
- ❑ Electrical power supplies and controls that sequence valve's, protective circuits, etc.
- ❑ Fixturing that attaches the part to be leak-tested to the leak testing equipment

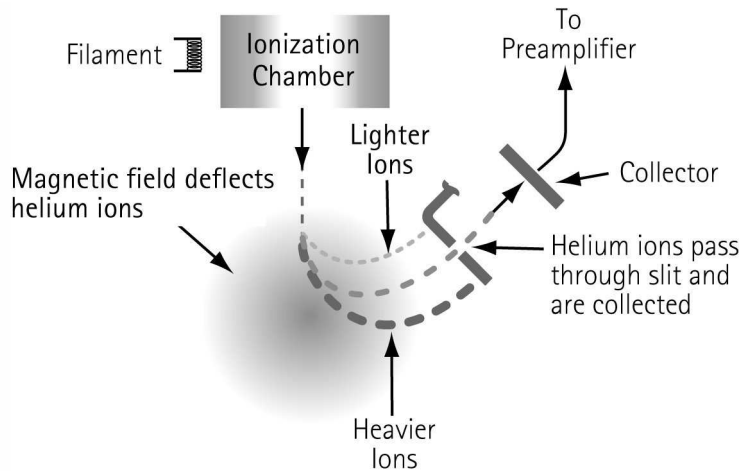

Figure B-1 Magnetic Separation Principle

Our *SIPD* family of products is also sensitive to helium and is based on a patented technology called Selective Ion Pump Detection (Figure B-2). The sensor technology incorporates an ion pump connected to a quartz capillary tube and maintained under high vacuum. This membrane is heated with a coiled platinum filament. Once heated, the membrane becomes permeable to helium. As the partial pressure of helium in the ion pump increases, so does the current draw of the ion pump. This current is proportional to the pressure and is therefore representative of the helium at the test probe of the instrument.

A selective ion pump detector consists of the following:

- ❑ An ion pump and controller
- ❑ A permeable quartz capillary
- ❑ A heater coil that surrounds the quartz capillary
- ❑ Electronics to process the signal
- ❑ Display for access to leak rate and other unit functions

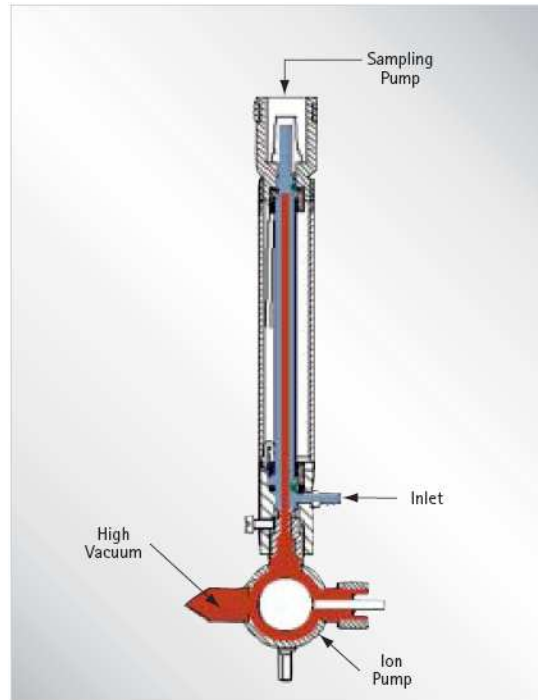

Figure B-2 Selective Ion Pump Detector

B.3 Methods of Leak Testing

There are many different ways to leak test parts using helium as a tracer gas. In general, the leak detection method is selected based on the actual working conditions of the part being tested. It is recommended that during leak testing, the same pressure differential be maintained and in the same *direction* as exists during the actual use of the part. For example, a vacuum system is tested with a vacuum inside the chamber, while a compressed air cylinder should be tested with a high pressure inside the cylinder.

There are two general concerns when leak testing. One is the location of leaks and the other is the measurement of the total leakage rate of the part, as some leakage may be acceptable. In many cases, parts may be first tested to determine if they pass an acceptable level, and if not, the part may be taken off line and subjected to a second test with the intent of locating the leak. Additionally, many parts may be tested in batches. If a batch fails, the individual parts in that batch may then be tested separately to identify the leaking part(s).

B.3.1 Vacuum Testing Method (Outside-in)

The part to be tested is evacuated with a separate pumping system for large volumes, or with just the leak detector itself. When the appropriate cross over pressure has been reached, the leak detector is valved-in or transfers into test and the part is tested using one of the following methods:

B.3.1.1 Locating Leaks

To pinpoint the location of the leak(s) (but not measure the total leakage rate), helium is administered to the suspected leak sites of the part using a spray probe with an adjustable flow (Figure B-3).

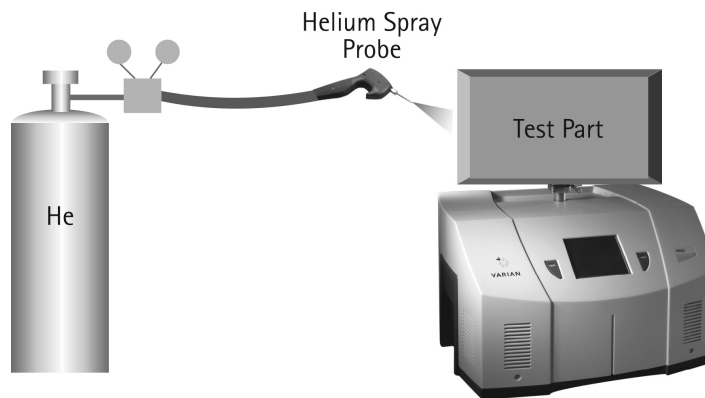

Figure B-3 Locating Leaks: Outside In

B.3.1.2 Measuring Leaks

To determine the total quantity of leakage (but not the number or location of leaks), the part is connected to the leak detector and shrouded by a helium environment. This helium environment can be contained in many methods ranging from a simple plastic bag to more complex bell jar arrangements (Figure B-4).

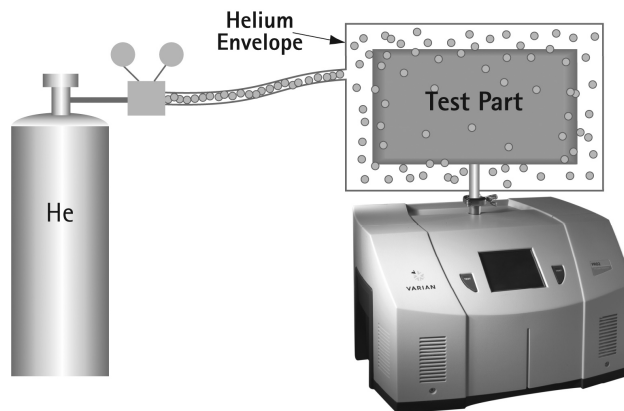

Figure B-4 Measuring Leaks: Outside In

B.3.2 Pressure Testing Method (Inside-out)

In this technique, the part is pressurized with helium or a mixture of helium and air, and tested by one of the following methods.

B.3.2.1 Measuring Leaks

To determine the total quantity of leakage (but not the number or location of leaks), the part is pressurized with helium (or a mixture of helium and air or nitrogen). This can be done by bombing or backfilling small hermetically sealed parts. Larger parts can be actively pressurized using a hose or tubing to deliver the helium. The part is placed in a volume that is then evacuated by the leak detector. All the helium escaping from the part is captured and quantified (Figure B-5).

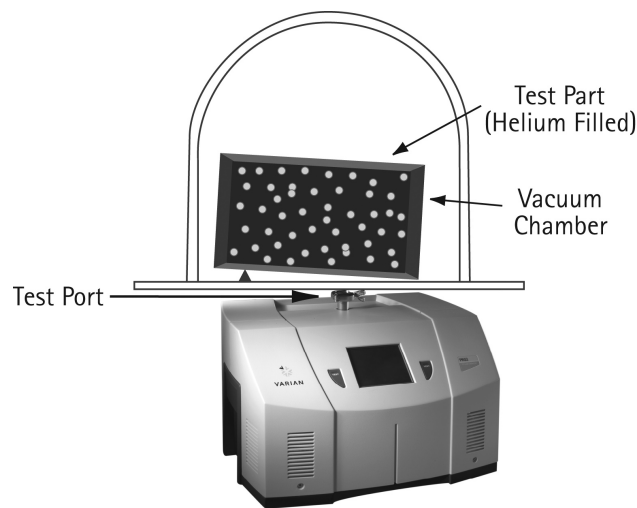

Figure B-5 Measuring Leaks: Inside Out

B.3.2.2 Locating Leaks

To pinpoint the location of the leak(s) (but not measure the total leakage), the likely potential leak sites of the part are scanned using a Sniffer Probe connected to the inlet of the leak detector (Figure B-6).

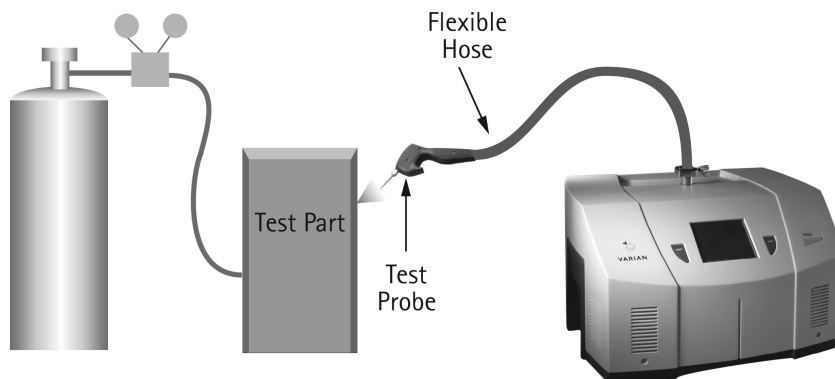

Figure B-6 Locating Leaks: Inside Out

VS Series Helium Mass Spectrometer Leak Detectors

B.3.2.2.1 Accumulation Testing Method

This method can both locate and quantify leaks. Some type of shroud or hood is placed in such a manner as to envelop a potential leak site. A certain amount of time is given to allow leaking helium to accumulate in the shrouded area, increasing the helium concentration. The leak detector is then valved-in to the shrouded volume. If many potential leak sites exist in a manifold or if many parts are to be tested at the same time, they can be sequentially valved-in to determine which site is leaking (Figure B-7).

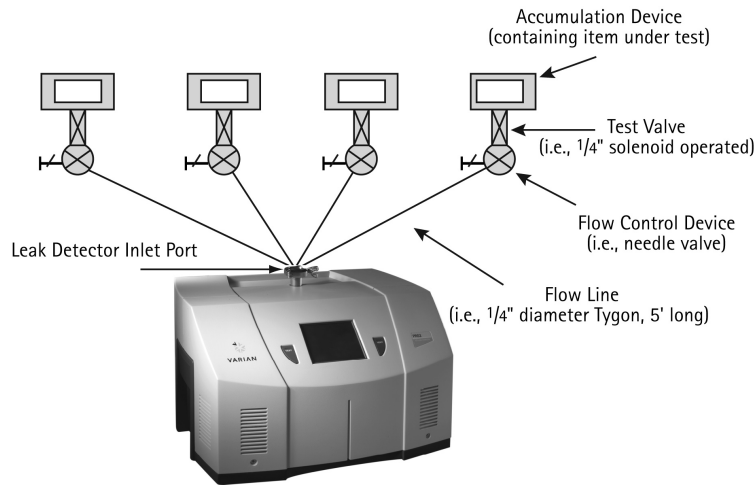

Figure B-7 Accumulation: Inside Out

B.3.3 System Leak Test Methods

Systems, like individual parts, should be tested with the same pressure differential and in the same direction as in actual use. Therefore, systems that are under vacuum while in operation should be leak tested under vacuum, while pressurized systems should be charged with helium to a pressure similar to operational conditions when possible.

B.3.3.1 Vacuum Systems

In general, vacuum systems are tested with a portable leak detector. Typically the leak detector is connected by means of a tee connected in between the foreline of the high vacuum pump and the inlet of its backing pump. A system should be capable of maintaining a foreline pressure low enough to operate the leak detector at this location. Helium is supplied to potential leak site using a spray probe or *bagging* suspected areas. If a leak exists, helium enters the system and rapidly diffuses through it. The leak detector should respond within several seconds or less. Leak detector sensitivity is diminished in systems with large backing pumps. If a system is using a cryopump as a high vacuum pump, it must be valved off before helium is introduced as cryopumps have limited helium pumping capacity (Figure B-8).

VS Series Helium Mass Spectrometer Leak Detectors

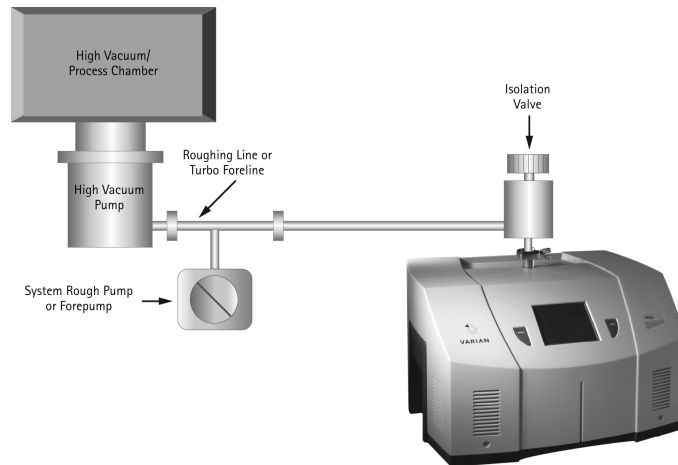

Figure B-8 Vacuum System

B.3.3.2 Pressurized Systems

Many different types of pressurized systems also need to be leak-free. These systems can be charged with helium or some mixture of helium and another gas such as nitrogen. If a diluted helium mixture is used, the helium signal is diminished proportionally. For example, if a mixture of 10% helium and 90% nitrogen is used, the signal reads 10% of the actual value of the leak, or a decade lower. This may be acceptable in many cases as system leak checking is usually to locate rather than quantify leaks. Once the system has been charged with an appropriate amount of helium, leak checking can be performed by means of a sniffer probe, or by *bagging* suspected leak sites so that leaking helium accumulates to a detectable level.

B.4 Typical Leak Detection Applications

B.4.1 Quality Control of Production Parts and Assemblies

The detection and location of leaks is critical in the production of many products from individual components, to subassemblies, to completed systems. In many of these cases, it is as important to know the size or rate of the leak, as it is the location. Whether quantitative or qualitative testing is required, our leak detectors help assure the leak integrity of your parts or assemblies. Some examples include:

Evacuated parts and assemblies

- Hermetically sealed electronic packages
- Valves and manifolding
- Feedthroughs/glass-to-metal seals
- Vacuum vessels and systems

Pressurized parts and assemblies

- Air conditioning and refrigeration assemblies
- Radiators, heat exchangers, and condensers
- Brake, fuel, and hydraulic lines
- Gas tanks
- Food storage tanks and packaging
- Body implantable medical devices
- High purity piping

B.4.2 Maintenance of Systems

Many vacuum process tools in fabs of all types require occasional leak checking. This may be part of a preventative maintenance schedule or in the event of an unexpected failure. Downtime in either case must be minimized. A rugged, dependable, fast starting leak detector is essential to maximize up time of production tools. Varian VS Series portable leak detectors keep industry moving. Examples of some of these applications are:

Vacuum process equipment or tools

- Vacuum furnaces
- Vacuum coaters
- Beam lines
- Electron beam and ion beam process equipment
- Analytical Instruments

- ❑ Semiconductor process tools
- ❑ Laser process equipment

Pressurized systems

- ❑ Power Plants
- ❑ Underground tanks, cables, and pipes
- ❑ High purity gas handling systems
- ❑ Bioreactors and fermenters
- ❑ Liquid gas manufacturing facilities
- ❑ Fuel tanks and bladders

B.4.3 System Integrated Leak Detection

Manufacturers of large, complex systems may choose to integrate into those systems a component leak detector that can facilitate the on-going maintenance of leak-free integrity, thereby providing additional value to their customers. The Varian VS C15 provides the necessary elements for flexible integration of leak detection capability into a large system. Examples of these systems are:

- ❑ Semiconductor process equipment
- ❑ PVD/CVD equipment
- ❑ E-beam and ion beam processing equipment

B.4.4 Mass Produced Parts

Some manufacturing processes require the integration of a leak-checking device into a multi-step process, usually with very high production rates. Component leak detectors are designed specifically for these applications in which a vacuum system and the control electronics may be mounted separately. The Varian VS C15 offers the ultimate flexibility in a helium mass spectrometer leak detection system. The flexibility, ruggedness and rapid response time of these units allows for accurate, repeatable, high volume leak testing in demanding production environments. Some examples include:

High Volume Manufactured Parts

- ❑ Automotive fuel systems
- ❑ Automotive brake components
- ❑ Cooling and refrigeration system components
- ❑ Medical devices
- ❑ Automotive airbag components
- ❑ Tire and wheel assemblies

VS Series Helium Mass Spectrometer Leak Detectors

Portable Sniffing Applications

Some applications require operators or technicians to look for leaks from a ladder, outdoors, above or below ground, or in a densely constructed industrial facility or power plant. In these cases, a mobile cart-mounted MSLD may not be practical. A truly portable unit such as the PHD-4 is required. Some examples of such applications are:

- Aircraft manufacturing and maintenance
- Power generating plants
- Pressurized pipelines
- Bioreactors and fermenters
- Petrochemical plants and refineries
- Underground tanks
- Large condensers or heat exchangers

Appendix C. Specifications

C.1 Specifications

The specifications for the leak detector are provided in Table C-1.

Table C-1 Leak Detector Series Specifications

Specifications	VS Series Helium Mass Spectrometer Versions			
Pumps	Rotary Vane		Dry Scroll	
Fore Pump Type	DS-42	DS-302	TS-620	IDP-3
Free Air Displacement, l/min, 60/50 Hz	45/38	285/237	500/420	60/50
Minimum Detectable Leak, atm-cc/sec	5×10^{-12}			
Internal Pump Version	DS-42/IDP-3			
Turbo Molecular Pump	Navigator™ Turbo molecular pump specifically designed for leak detection			
Leak Units	atm-cc/sec, mbar-l/sec, torr-l/sec, Pa-m ³ /sec, std. ft ³ /year			
Peak Pumping Speed	<ul style="list-style-type: none"> <input type="checkbox"/> Contra w/ DS42 – 0.5 l/sec for N₂ and He at 60Hz in Contra (.42 l/sec @ 50Hz). <input type="checkbox"/> Contra w/ DS302 – 3.0 liters/sec for N₂ and He at 60Hz (2.5 l/sec @ 50 Hz). <input type="checkbox"/> Contra w/ TS620 – 6.0 liters/sec for N₂ and He at 60Hz (5.0 l/sec @ 50 Hz). <input type="checkbox"/> Contra w/IDP-3 - 6.0 l/sec (60 Hz), 5.0 l/sec (50 Hz) <input type="checkbox"/> Midstage – 1.8 liters/sec for He at 50 or 60 Hz. 			
Helium Response Time	0.5 second, within 66% of peak reading within the given time. Per AVS 2.1.			
Test Port	NW-25; A 1 ¹ / ₈ " (28 mm) ID Compression Port is available as an accessory.			
Recommended Operating Ambient Conditions				
Installation	Indoor use only. Altitude up to 2000 m (6,400'), Material Group III, POLLUTION DEGREE 2 according to EN61010-1 Standard, Class 1			
Operating Temperature	System: +12° C to +45° C (wet and dry pumps); Fore pump limited on the low ends and turbo pump limited on the high ends.			
Humidity	Maximum relative humidity (HR) 90%			
Heat Load	1000 W (+/- 5%)			
Air Pressure	563 Torr (75 kPa) to 795 Torr (106 kPa)			
Maximum system vibration	3 G's (Turbo Limit)			

VS Series Helium Mass Spectrometer Leak Detectors

Table C-1 Leak Detector Series Specifications (Continued)

Specifications	VS Series Helium Mass Spectrometer Versions
Storage Ambient Conditions	Relative humidity: 0% to 95%, non-condensing. Temperature: -20 °C (-4 °F) to +60 °C (140 °F)
Power Requirements	Input Power <input type="checkbox"/> 100 VAC, 50 Hz, 20 A <input type="checkbox"/> 115 VAC, 60 Hz, 20 A or <input type="checkbox"/> 230 VAC, 50/60 Hz, 12 A Max. Branch Circuit Breaker: 20A with motor-rated time delay.
Dimensions	See outline drawings (Figure 1-1 on page 1-3 to Figure 1-5 on page 1-10).
Weight	PR02 with built in DS-42 mechanical pump: 38 kg* MR15 w/DS-302 rotary vane pump on cart: 81 kg* MD30 w/TS-620 dry scroll pump on cart: 92 kg* PD03 with IDP-3 dry pump: 40 kg* * Add 1.0 kg if the Wireless Remote and optional I/O features are installed.
LCD display	Size = 112 mm x 150 mm, overall, 90 mm x 115 mm viewing area (HxW) Color, ¼ VGA (320 x 240), backlit.
Regulatory	Safety: <input type="checkbox"/> Low Voltage Directive (LDV) 73/23/EEC:1973 as Amended by 93/68/EEC:1993 EMC: <input type="checkbox"/> Electromagnetic Compatibility (EMC) Directive 89/336/EEC:1989 as Amended by 93/68/EEC:1993 <input type="checkbox"/> Radio and Telecommunication Terminal Equipment (R&TTE) Directive, 1999/5/EC: 1999 For particular Safety and EMC Standards see Declaration of Conformity.
Single rotation speed	Turbo: 70K RPM
Leak test range	E-11 to E-4
Maximum spectrometer pressure	1E-04 Torr - Filament turns off when pressure exceeds this point
Contra cross over	10 Torr decreasing, 12 Torr increasing
Sensitivity in High Pressure Test mode	1×10^{-8} atm.cc.sec