



Agilent Technologies



XGS-600™ Gauge Controller

INSTRUCTION MANUAL

Manual No. 699908410

Revision A

January 2012

XGS-600 Gauge Controller

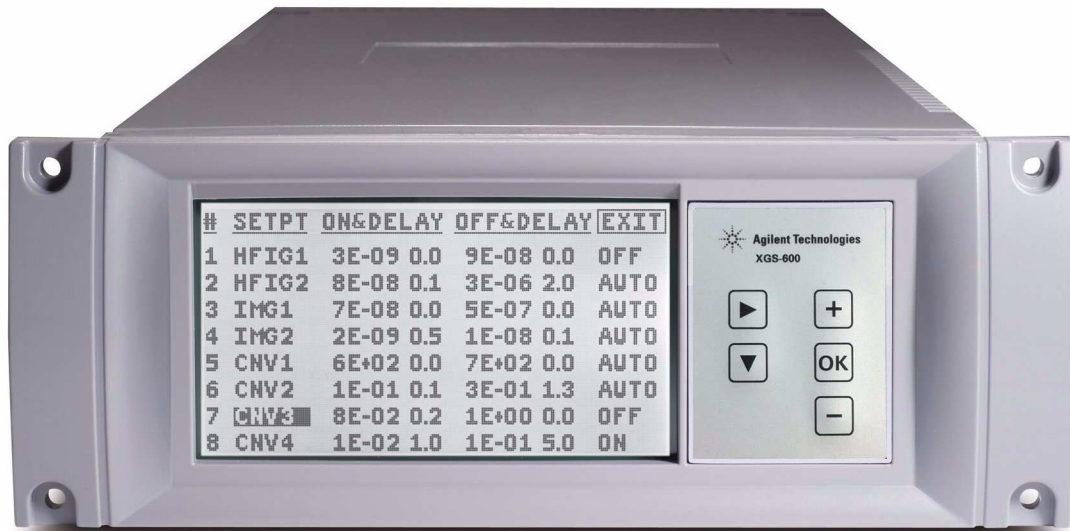

Warranty

Products manufactured by Seller are warranted against defects in materials and workmanship for twelve (12) months from date of shipment thereof to Customer, and Seller's liability under valid warranty claims is limited, at the option of Seller, to repair, to replace, or refund of an equitable portion of the purchase price of the Product. Items expendable in normal use are not covered by this warranty. All warranty replacement or repair of parts shall be limited to equipment malfunctions which, in the sole opinion of Seller, are due or traceable to defects in original materials or workmanship. All obligations of Seller under this warranty shall cease in the event of abuse, accident, alteration, misuse, or neglect of the equipment. In-warranty repaired or replaced parts are warranted only for the remaining unexpired portion of the original warranty period applicable to the repaired or replaced parts. After expiration of the applicable warranty period, Customer shall be charged at the then current prices for parts, labor, and transportation.

Reasonable care must be used to avoid hazards. Seller expressly disclaims responsibility for loss or damage caused by use of its Products other than in accordance with proper operating procedures.

Except as stated herein, Seller makes no warranty, express or implied (either in fact or by operation of law), statutory or otherwise; and, except as stated herein, Seller shall have no liability under any warranty, express or implied (either in fact or by operation of law), statutory or otherwise. Statements made by any person, including representatives of Seller, which are inconsistent or in conflict with the terms of this warranty shall not be binding upon Seller unless reduced to writing and approved by an officer of Seller.

Warranty Replacement and Adjustment

All claims under warranty must be made promptly after occurrence of circumstances giving rise thereto, and must be received within the applicable warranty period by Seller or its authorized representative. Such claims should include the Product serial number, the date of shipment, and a full description of the circumstances giving rise to the claim. Before any Products are returned for repair and/or adjustment, written authorization from Seller or its authorized representative for the return and instructions as to how and where these Products should be returned must be obtained. Any Product returned to Seller for examination shall be prepaid via the means of transportation indicated as acceptable by Seller. Seller reserves the right to reject any warranty claim not promptly reported and any warranty claim on any item that has been altered or has been returned by non-acceptable means of transportation. When any Product is returned for examination and inspection, or for any other reason, Customer shall be responsible for all damage resulting from improper packing or handling, and for loss in transit, notwithstanding any defect or non-conformity in the Product. In all cases, Seller has the sole responsibility for determining the cause and nature of failure, and Seller's determination with regard thereto shall be final.

If it is found that Seller's Product has been returned without cause and is still serviceable, Customer will be notified and the Product returned at Customer's expense; in addition, a charge for testing and examination may be made on Products so returned.

This page intentionally left blank.

Contents

Preface	v
Hazard and Safety Information	v
EMC Warnings	vi
Introduction	1-1
Backwards Compatibility	1-1
Part Number Scheme	1-1
XGS-600 Front and Back Description	1-2
Unit Dimensions	1-4
Installation	2-1
Connect the Unit.....	2-1
Operating Instructions	3-1
Operational Screens.....	3-1
Service and Troubleshooting	4-1
Troubleshooting.....	4-6
Appendix A. XGS-600 Gauge Specifications	A-1
Instrument Specifications	A-1
Board Specifications/Descriptions	A-5
I/O Pin Assignments.....	A-10
XGS-600 vs MultiGauge and SenTorr Backwards Compatibility Detail.....	A-13
Appendix B. ASCII Serial Commands	B-1
Appendix C. BCD Serial Commands	C-1
Appendix D. Gas Correction Factor Table	D-1

This page intentionally left blank.



**Declaration of Conformity
Konformitätserklärung
Déclaration de Conformité
Declaración de Conformidad
Verklaring de Overeenstemming
Dichiarazione di Conformità**

We
Wir
Nous
Nosotros
Wij
Noi

Agilent Technologies
121 Hartwell Avenue
Lexington, MA, 02421-3133 USA

declare under our sole responsibility that the product,
erklären, in alleniniger Verantwortung, daß dieses Produkt,
déclarons sous notre seule responsabilité que le produit,
declaramos, bajo nuestra sola responsabilidad, que el producto,
verklaren onder onze verantwoordelijkheid, dat het product,
dichiariamo sotto nostra unica responsabilità, che il prodotto,

XGS-600 Gauge Controller

to which this declaration relates is in conformity with the following standard(s) or other normative documents.
auf das sich diese Erklärung bezieht, mit der/den flogenden Norm(en) oder Richtlinie(n) übereinstimmt.
auquel se réfère cette déclaration est conforme à la (auz) norme(s) ou au(x) document(s) normatif(s).
al que se refiere esta declaración es conforme a la(s) norma(s) u otro(s) documento(s) normativo(s).
waamaar deze verklaring verwijst, aan de volende norm(en) of richtlijn(en) beantwoordt.
a cui se riferisce questa dichiarazione è conforme alla/e sequente/I norma/o documento/I normativo/i.

- EN 55011 (1991) Group 1 Class A ISM emission requirements
- EN 61010-1 (1993) Safety requirements for electrical equipment for measurement, control, and laboratory use incorporating Amendments Nos 1 and 2.
- EN 61000-3-2 (2006) Limits for harmonic current emissions (equipment input current up to and including 16A per phase).
- EN 61000-3-3 (2005) Limitation of voltage fluctuations and flicker in low-voltage supply systems for equipment with rated current up to and including 16A.
- EN 61326 (1997/A1; 1998/A2; 2001/A3) EMC requirements for Electrical equipment for measurement, control and laboratory use — General Use.
- EN 61326 (1997/A1; 1998/A2; 2001/A3) EMC requirements for Electrical equipment for measurement, control and laboratory use
- EN 61000 - 4-2 (2001) Electrostatic Discharge Immunity
- EN 61000 - 4-4 (2004) Electrical Fast Transient Immunity
- EN 61000 - 4-5 (2005) AC Lightning Surge Immunity

John Ehman
Operations Manager
Agilent Technologies
Lexington, Massachusetts, USA



This page intentionally left blank.

Preface

Hazard and Safety Information

This manual uses the following standard safety protocols:

WARNING



The warning messages are for attracting the attention of the operator to a particular procedure or practice which, if not followed correctly, could lead to serious injury.

CAUTION



The caution messages are displayed before procedures, which if not followed, could cause damage to the equipment.

VOLTAGE



Alerts the user to the presence of uninsulated dangerous voltage within the product's enclosure that may be of sufficient magnitude to constitute a risk of electric shock to persons.

NOTE



The notes contain important information.

This product must only be operated and maintained by trained personnel. Board installation/replacement requires a properly trained service technician.

Before operating or servicing equipment, read and thoroughly understand all operation/maintenance manuals provided by Agilent Technologies. Be aware of the hazards associated with this equipment, know how to recognize potentially hazardous conditions, and how to avoid them. Read carefully and strictly observe all cautions and warnings. The consequences of unskilled, improper, or careless operation of the equipment can be serious.

In addition, consult local, state, and national agencies regarding specific requirements and regulations. Address any safety, operation, and/or maintenance questions to your nearest Agilent Technologies office.

EMC Warnings

EN 55011 Class A Warning

This is a Class A product. In a domestic environment this product may cause radio interference in which case the user may be required to take adequate measures.

The XGS-600 was tested with Agilent Technologies manufactured gauge cables whose pigtails are connected to the XGS-600 ground stud, and with I/O cables (for remote control, serial communications and set points) employing combined foil-braid shields and metal shell connectors with the shields connected to the XGS-600 chassis. Compliance with FCC Part 15 rules and the European Union's EMI requirements cannot be assured unless Agilent Technologies supplied gauge cables, foil-braid shielded I/O cables with metal shell connectors are used and the included clamp-on ferrite bead is installed onto the AC power (mains) cord. Failure to install the unit in this way may result in the failure to meet the requirements for radiated emissions and susceptibility.

When using glass BA type gauges, it is possible that the limits for radiated emissions may be exceeded under certain operating conditions due to the lack of shielding of these devices. Add supplemental shielding for the glass BA gauge by installing a grounded metal cage or screen that completely surrounds the gauge, but still allows for air flow. This reduces emissions to acceptable levels and provides additional protection against accidental breakage of the glass BA gauge.

FCC

This device complies with Part 15 of the FCC rules. Operation is subject to the following two conditions: (1) This device may not cause harmful interference, and (2) this device must accept any interference received, including interference that may cause undesirable operation.



The equipment has been tested and found to comply with the limits for a Class A digital device, pursuant to Part 15 of the FCC rules. These limits are designed to provide reasonable protection against harmful interference when the equipment is operated in a commercial environment. This equipment generated, uses, and can radiate radio frequency energy and, if not installed and used in accordance with the instruction manual, may cause harmful interference to radio communications. Operation of this equipment in a residential area is also likely to cause harmful radio communications interference in which case the user will be required to correct the interference at his own expense.

NOTE



It has been observed that transient electromagnetic phenomena (electrostatic discharges and power line voltage spikes and/or surges) can cause the XGS-600 to become blank. If this occurs, the screen should recover in approximately five seconds. Only the screen is affected, measurements, setpoint state, analog outputs and serial communications are not affected.

This page intentionally left blank.

Chapter 1: Introduction

Congratulations on your purchase of the XGS-600. This product represents a major advance in the simplicity, functionality and performance of vacuum gauge controllers. It was conceived after extensive interviews with end users in a variety of applications. Its design incorporates the latest in electronics and is certified to CE and CSA requirements, and is RoHS compliant. It is compact, taking only 1/2 rack and it is simply without peer in terms of its capacity, usability and capability.

You can view up to 8 gauges on one screen and can employ as many as 5 ion gauges or 12 convection or Agilent gauges in one unit. With its simple user interface (designed to be operated without a manual) and its many standard features (8 set points, serial communication, universal voltage and pressure units), vacuum measurement is simplified. And where speed is necessary for certain critical applications it was designed to process a signal in less than 20 milliseconds. These are just some of the many features that make the XGS-600, a unique and powerful device. Once you have used the XGS-600, we trust that you, too will find that it is not only a convenient and economical tool in your vacuum system but an indispensable one as well.

Read this manual carefully to discover all the capability of this device, but if you don't have time, simply turn it on and navigate through the screens to get started.

Backwards Compatibility

The XGS-600 is designed to be substantially backwards compatible with the SenTorr and MultiGauge instruments. Refer to page A-13 for a full description.

Part Number Scheme

ORDERING INFORMATION	
Description	Part Number
XGS-600 Vacuum Controller, without cards	XGS600H0M0C0
Configure your XGS-600 Controller with cards – constructing your part number:	XGS600HXMXX
1 Refer to the Gauge Selection Chart to help determine the gauge you need	
2 Choose the number of HFIG** cards you want; place after the "H"; will be 0 to 4	
3 Choose the number of IMG* cold cathode cards you want; place after the "M"; will be 0 to 5	
4 Choose the number of Dual Convection Gauge Cards; place after the "C"; each card runs two convection type gauges, will be 0 to 6	
5 If ordering Active Gauge (Analog Input) Cards, add "X" to the end of the part number, with the number of cards desired. Each card operates two Active Gauges; will be 1 to 6. For example, XGS600H0M0C0A X	
Note:	
• The XGS-600 has 6 gauge card slots permitting a total of 6 cards.	
• Up to four slots can be used for HFIG** cards. If four of these are chosen, one IMG* card or up to two Dual Convection Gauge Cards may be selected also.	
• Up to five slots can be used for IMG* cards. If five of these are chosen, no additional gauge cards may be selected.	
• All six slots may be used for Dual Convection Gauge Cards or Analog input Cards.	
HFIG, IMG and Dual Convection Cards can be used with the Dual Analog Input Card.	

** HFIG = Hot Filament Ion Gauge

* IMG = Inverted Magnetron Gauge

XGS-600 Front and Back Description

The display is biased so as to be best viewed from directly in front or slightly above.

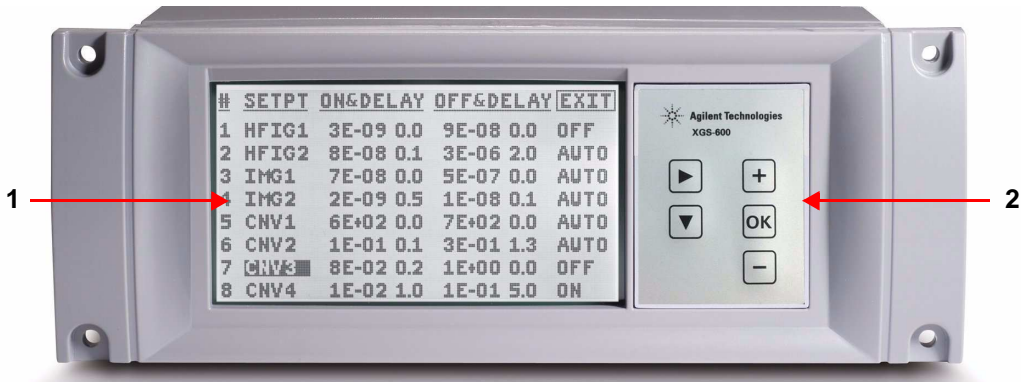

Figure 1-1 XGS-600 Front Panel

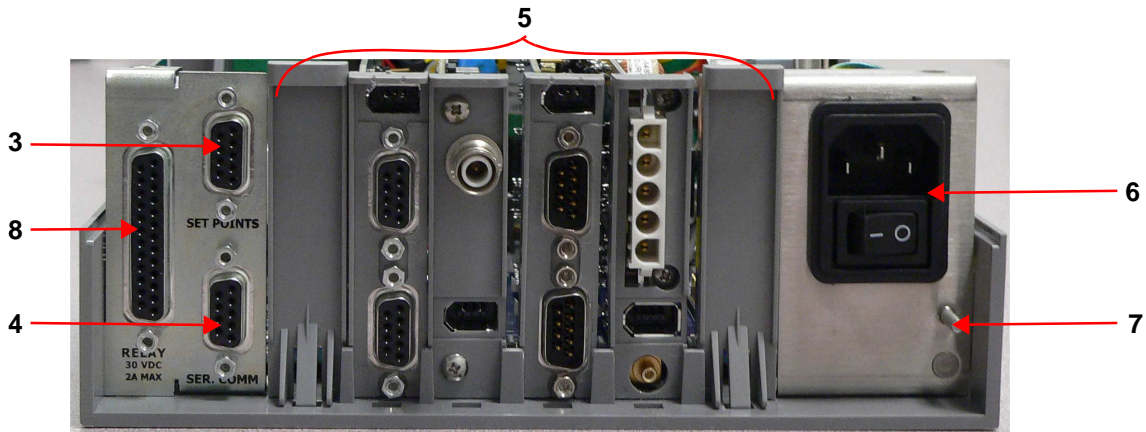

Figure 1-2 Backplate Connections (CNV, IMG, Analog and HFIG boards shown)

Table 1-1 Front/Rear Panel Components

Item	Description	Page
1	Display	See "Screen Flow" on page 3-1.
2	Keypad/Navigation Keys	See "General Navigation and Data Entry" on page 3-2.
3	Open-Collector Set Point Outputs	See "Set-Point Connector Pin Assignments" on page A-11.
4	Serial Communication Connector	"Serial Connector Pin Assignments" on page A-11.
5	Gauge Board Slots (6)	See "Board Specifications/Descriptions" on page A-5.
6	On/Off Power Switch and AC Power Plug Receptacle	See "Connect the Unit" on page 2-1.

XGS-600 Gauge Controller

Table 1-1 Front/Rear Panel Components (Continued)

Item	Description	Page
7	Ground Connection	See "Connect the Unit" on page 2-1.
8	Setpoint Relay Connector	See "Connect the Unit" on page 2-1.

NOTE



The Relay board provides additional compatibility when replacing a Multigauge or senTorr controller. However, the relays have a maximum rating of ≤ 30 VDC at < 2 A. See Table A-1 on page A-1 for additional specifications.

XGS-600 Gauge Controller

Unit Dimensions

Figure 1-3 shows the unit dimensions with mm in brackets.

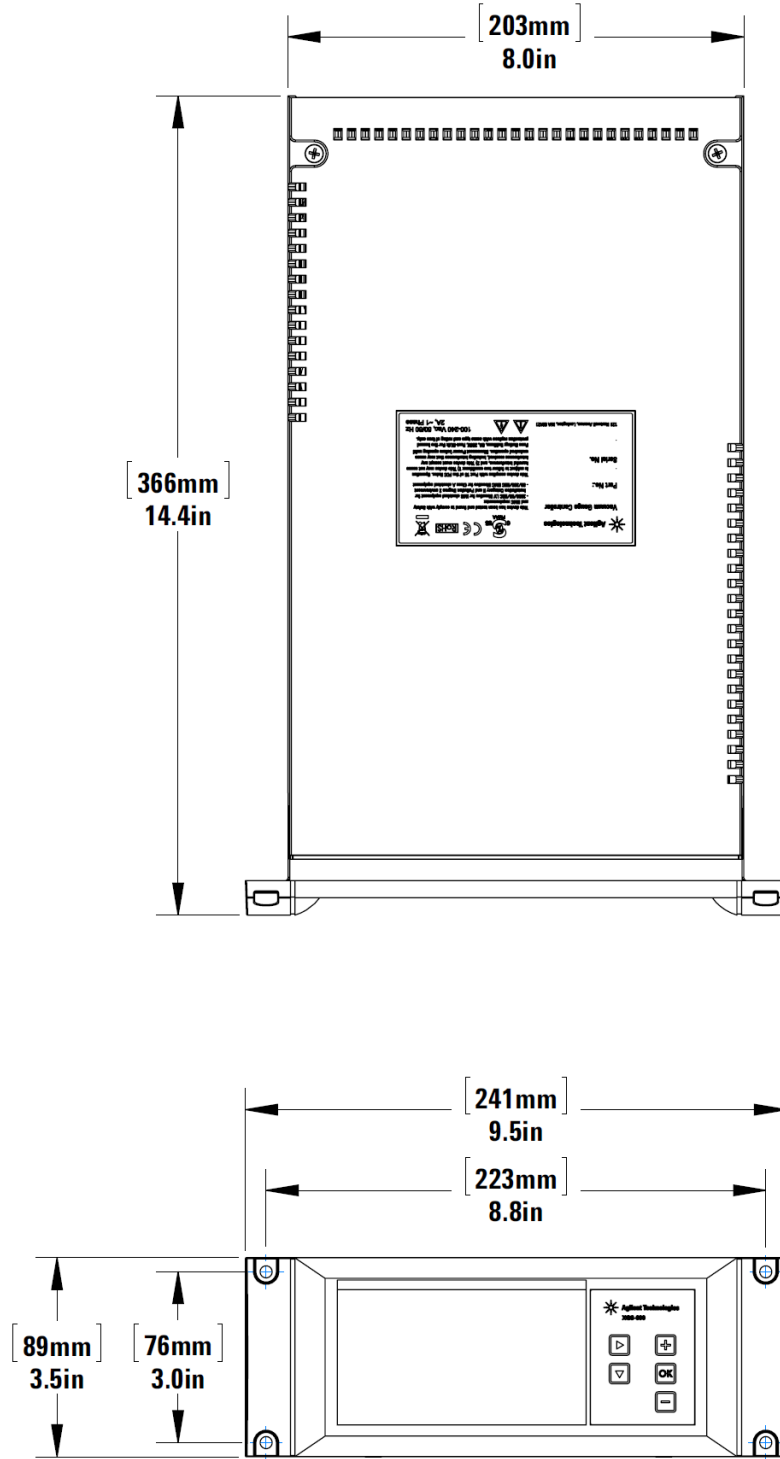

Figure 1-3 XGS - 600 Dimensions

Chapter 2: Installation

Each XGS-600 unit is inspected and carefully packed prior to shipment. If the unit arrives damaged, save the packing materials and immediately notify the carrier. Because the packing materials are designed specifically for this instrument, always use them when transporting the unit. The shipping container is packed with the following contents:

- ❑ XGS-600 gauge controller
- ❑ AC line cord
- ❑ Operating manual
- ❑ Rubber feet, adhesive
- ❑ Clamp-On Ferrite Bead

Connect the Unit

The unit comes shipped with sensor boards configured according to customer requirements.

CAUTION



Do not block air vents. Allow approximately 3/4" clearance at each side of the enclosure for proper air flow.

1. Install the included ferrite bead onto the AC power (Mains) cable near the XGS-600 chassis. Ensure that the locking tab is fully engaged.
2. Plug the AC line cord into the receptacle on the rear panel of the unit and into the power source. Keep power off while connecting the remaining cables.
3. Connect gauge and I/O cables depending on controller configuration according to Figure 2-1:

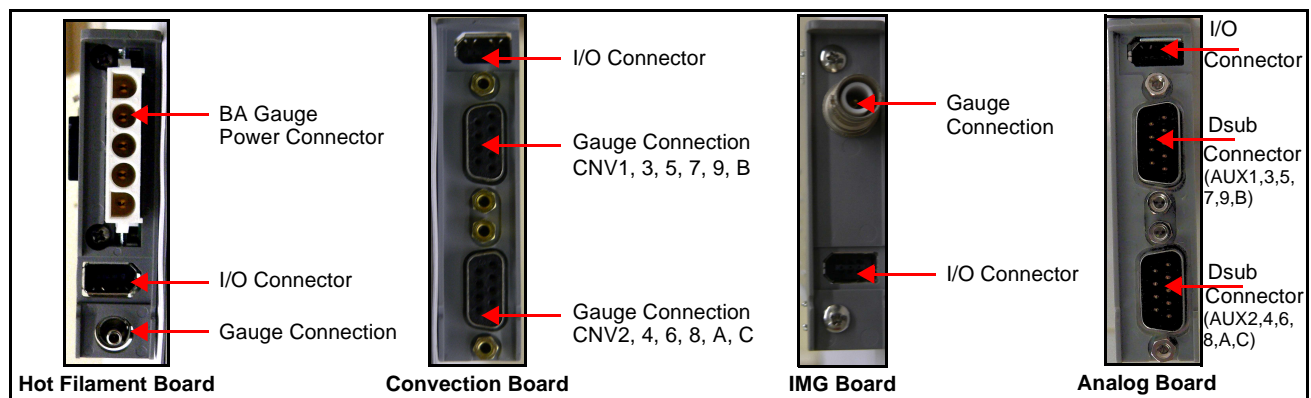

Figure 2-1 Gauge Board Rear Connections

XGS-600 Gauge Controller



When installing and HFIG cable, make sure to connect the pig tails from the ground cable to the ground stud. See item 7 in Figure 1-2.

The Analog Board is identified by the Dsub connector pin contacts versus the Convection Board socket contacts.

4. Turn on the unit using the rear panel power switch.



Gauges and accessories are available for the XGS-600 controller such as rack mount hardware, gauge and I/O cables, and a tilt stand. See Table 2-1 and Table 2-2.

Table 2-1 XGS-600 Accessories

Cables	Part Number							
Cable Description	3 ft.	10 ft.	25 ft.	50 ft.	65 ft	75 ft	90 ft	100 ft
UHV-24/UHV-24p PTFE UHV, bakeable to 250° C		R32463010	R32463025	R32463050				
UHV-24/UHV-24p Standard, non-bakeable		R32453010	R32453025	R32453050				
Glass BA Gauge Standard, non-bakeable		R32443010	R32443025	R32443050				
Ion Gauge Extension					R32473065		R32473090	
MBA-100 Gauge		R32483010	R32483025	R32483050				
IMG-100 Gauge		R03113010	R03113025	R03113050		R03113075		R03113100
IMG-UHV Gauge		R03413010	R03413025		R03413065			R03413100
Thermocouple Gauge		L91313010	L91313025	L91313050		L91313075		L91313100
ConvecTorr Gauge, Non-Bakeable		L91223010	L91223025	L91223050				L91223100
XGS-600 I/O		R32493010	R32493025	R32493050	Special Order			
CT-100 with Analog Input Card	R35883003	R35883010	R35883025	R35883050				
FRG700/PVG/PCG with Analog Input Card	R35893003	R35893010	R35893025	R35893050				
CDG500, MKS with Analog Input Card	R35903003	R35903010	R35903025	R35903050				
FRG720/730 with Analog Input Card	R35913003	R35913010	R35913025	R35913050				

XGS-600 Gauge Controller

Table 2-1 XGS-600 Accessories (Continued)

Cables		Part Number	
Other Accessories	Part No.	Power Cord Selection	Part No.
HFIG** PCB, Field Install	R3075301	Europe, 10A /220-230 VAC, 2.5 Meter	656494220
IMG* PCB, Field Install	R3080301	Denmark, 10A/220-230 VAC, 2.5 Meter	656494225
Thermocouple/Convectur Gauge card PCB, Field Install	R3084301	Switzerland, 10A/230 VAC, 2.5 Meter	56494235
Analog Input PCB, Field Install	R3487301	UK/Ireland, 13A/230 VAC, 2.5 Meter	656494250
Tilt Stand Accessory	R3124301	India, 10A/220-250 VAC, 2.5 Meter	656494245
Center Rack Mount Kit	L6423301	Israel, 10A/230 VAC, 2.5 Meter	656494230
Off-Center Rack Mount Kit	L6422301	Japan, 12A/100 VAC, 2.3 Meter	656494240
Dual Mount Rack Mount Kit	L6426301	North America, 15A/125 VAC, 2.0 Meter	656458203
Four Channel TC Cable Adapter	R3299301	North America, 10A/230 VAC, 2.5 Meter	656494255
MHV-SHV Adapter	648072683		

XGS-600 Gauge Controller

Rack Mounting Instructions

Depending on Rack Mounting kit selected, assemble per Figure 2-2.

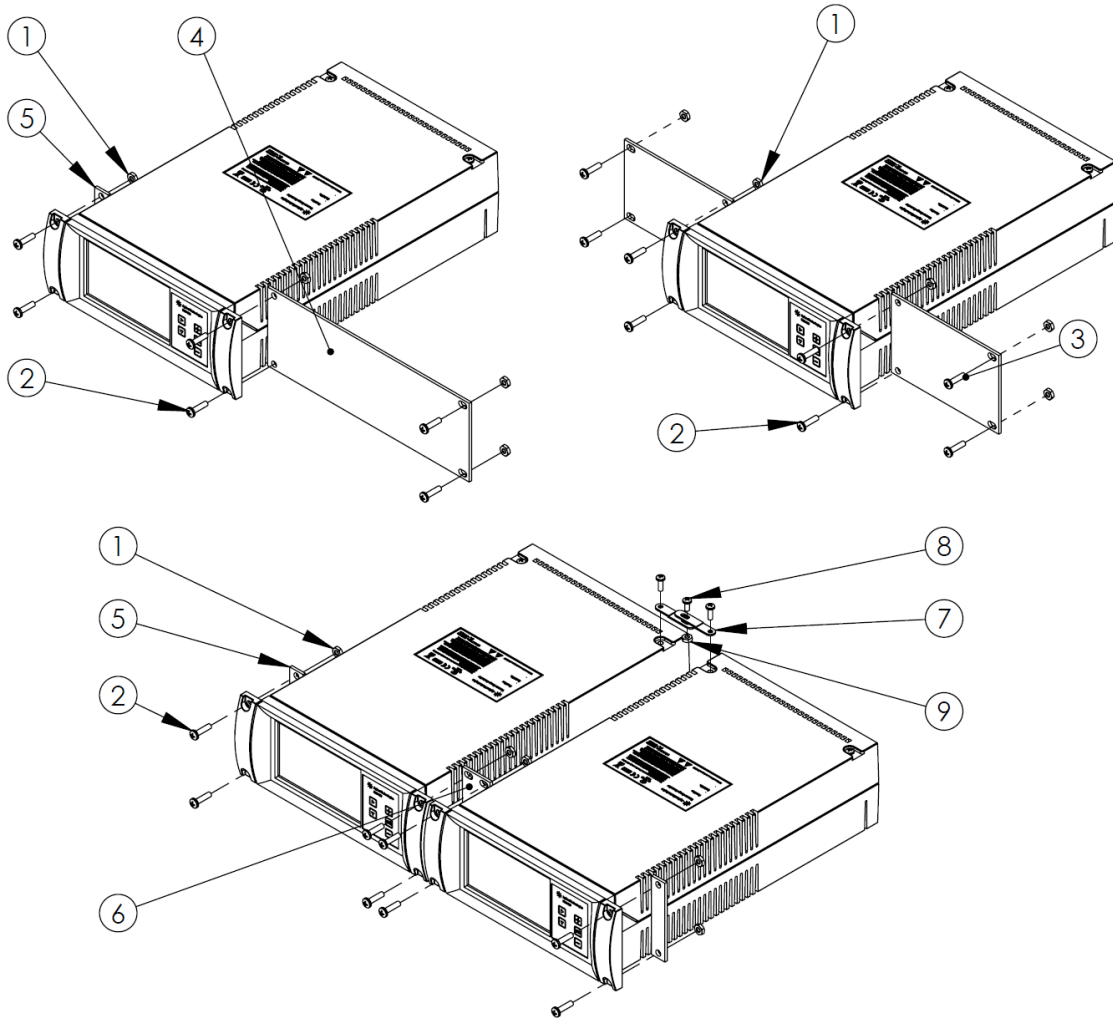

RACK MOUNTING KITS					
ITEM NO.	PART NUMBER	DESCRIPTION	CENTER MOUNT/QTY.	OFFCENTER MOUNT/QTY.	DUAL CONTROLLER/QTY.
1	617812042	NUT, KEPS, 10-32 CAPLT	8	6	8
2	614410465	SCREW PAN HD PHIL10-32X3/4 STL,BLK OXIDE	8	6	8
3	L6415001	RACK MOUNT, SIDE PLATE (CENTER MOUNT)	2	-	-
4	L6417001	RACK MOUNT, OFFSET PLATE	-	1	-
5	L6416001	RACK MOUNT, SIDE PLATE	-	1	2
6	L6414001	RACK MOUNT, CENTER PLATE	-	-	1
7	L6424001	LINK, REAR TIE IN	-	-	2
8	614420321	SCREW, PAN HD, PHIL, 8-32 X 3/8, S/S	-	-	1
9	617812035	NUT KEPS 8-32, CAPLT, STEEL, ZINC PLATED	-	-	1

Figure 2-2 Rack Mounting Instructions

XGS-600 Gauge Controller

Table 2-2 Gauge Selection Chart

Controller Gauge Card								
Vacuum Regime	Convection	Hot Filament	Cold Cathode	Analog	Gauge Type	Recommendation	Gauge Characteristics	
	C	H	M	A				
Rough ATM to 10 ⁻³	✓				ConvecTorr	Best overall convection gauge for accuracy repeatability, secure connection	<ul style="list-style-type: none"> Stainless steel Pipe thread, KF and CFF Locking bayonet connector 	
	✓				536	Same vacuum performance as the ConvecTorr but without bayonet connector	<ul style="list-style-type: none"> Stainless steel Pipe thread, KF and CFF 	
	✓				531	Most economical rough gauge	<ul style="list-style-type: none"> Lowest cost Mild steel Pipe thread 	
					✓	CT-100	Most economical gauge	<ul style="list-style-type: none"> Active gauge - TC
					✓	PVG Series	Smallest active gauge for rough vacuum applications	<ul style="list-style-type: none"> Active gauge - Pirani
					✓	PCG Series	Combination CDG and Pirani	<ul style="list-style-type: none"> Active gauge CDG and Pirani - Good for rapid venting to atmosphere
					✓	CDG500	Accurate and reliable, fast response	Capacitance diaphragm gauge - Fast response, gas independent over whole range
High 10 ⁻³ to 10 ⁻⁹		✓			572 (glass)	Most popular general purpose HV gauge (hot filament)	<ul style="list-style-type: none"> Measures to 1 × 10⁻⁹ Torr Tungsten filaments - More accurate and repeatable Glass - Can see when it is on 	
			✓		563 (glass)	Best general purpose HV gauge (hot filament) for overall performance and reliability	<ul style="list-style-type: none"> Measures to 1 × 10⁻⁹ Torr Thoriated iridium filament - More robust with better burnout resistance Glass - Can see when it is on Platinum coating - Provides higher performance in the 10⁻⁴ range and a measure of EMI shielding 	
			✓		571 (glass)	Same as 563 without platinum coating	<ul style="list-style-type: none"> Less expensive than the 563 	
			✓		MBA-100 (one filament, metal case)	Break resistant HV gauge (hot filament)	<ul style="list-style-type: none"> Measures to 10⁻⁹ Torr General purpose hot filament with metal housing (not glass), so it will not break Uses less power than glass gauges. Well shielded Available in tungsten and thoriated iridium filament (see 572 and 563 above) 	
					MBA-200 (two filaments, metal case)			

XGS-600 Gauge Controller

Table 2-2 Gauge Selection Chart (Continued)

Controller Gauge Card							
Vacuum Regime	Convection	Hot Filament	Cold Cathode	Analog	Gauge Type	Recommendation	Gauge Characteristics
	C	H	M	A			
			✓		IMG-100 Inverted Magnetron	Most durable and fastest responding HV gauge (cold cathode)	<ul style="list-style-type: none"> • General purpose-measures to 2×10^{-9} Torr • Small, reliable, extremely rugged - Will not burn out • Very fast response - < 20 milliseconds • Less accurate and repeatable than hot filament • Longer starting in high vacuum than a hot filament • Can be cleaned
				✓	FRG700/702	Combination full range gauge	• Active gauge - Pirani/Cold Cathode
				✓	FRG720/730	Combination full range gauge	• Active gauge - Pirani/Hot Filament
Ultra High 10 ⁻⁹ to 10 ⁻¹²			✓		IMG-300 Inverted Magnetron	Most durable and fastest responding UHV gauge (cold cathode)	<ul style="list-style-type: none"> • Measures to 1×10^{-11} Torr • Bakeable with magnet to 250 °C • Bakeable without magnet to 450 °C • Reliable, rugged, will not burn out • Can be cleaned
		✓			UHV-24 (nude)	Most popular UHV gauge (hot filament)	<ul style="list-style-type: none"> • Measures to 1×10^{-10} Torr • Bakeable with magnet to 250 °C • Thoriated iridium filaments run cooler - less outgassing • Dual tungsten filaments run hotter - More outgassing but measurements are more accurate and repeatable
		✓			UHV-24p (nude)	UHV gauge providing the highest vacuum reading	• Same as UHV-24 except it measures to 2×10^{-11} Torr

BA Cross Reference

The XGS-600 controller is compatible with many competitor gauges. Table 2-3 list which Agilent gauge setting to use for each of gauges. See "Sensor Setup Screen" on page 3-9.

Table 2-3 BA Cross Reference

GP	ETI	MDC	Huntington	Kurt Lesker	Duniway
Select Sensor model 572 for the following:					
274012	4336-TP/1		TP-100	G100TF	T-075-N
274013	4336-TP		TK-100	G075TK	T-075-P
274015	4336-TK		TK-100-F		T-075-K
274016	4336-TK/1				T-100-N
274017					T-100-K
274018					T-100-P

XGS-600 Gauge Controller

Table 2-3 BA Cross Reference (Continued)

GP	ETI	MDC	Huntington	Kurt Lesker	Duniway
274021					T-CFF-133
					T-CFF-275
					T-KF25
					T-KF40
Select Sensor model 571 for the following:					
274002	4336-P	IGT-075	IP-100	G075F	I-075-N
274003	4336-K	IGT-100	IK-100	G100F	I-075-P
274005	4336-F		IK-100-F	G100KQF25	I-075-K
274006	4336-P/1		IP-150	G100KQF40	I-100-N
274008	4336-F/1		IK-150	G075N	I-100-K
274020	4336-K/1		IK-150-F	G100K	I-100-P
274032	8140				I-CFF-133
274028					I-CFF-275
274043					I-KF25
					I-KF40
Select Sensor model UHV24 for the following:					
274022	8130	UH TT	IGT-T	G8130	T-NUDE-F
274023	8130T	UH IR	IGT-TI	G8130T	I-NUDE-F
274041		BATT			
274042		BAIR			
Select Sensor model 563 for the following:					
				G8140	I-075-NC
				G8120	I-075-KC
				G8140-DI	I-100-NC
				G100K-PT	I-100-KC
				G100F-PT	I=CFF-275
					I-NUDE-BAC
Select Sensor model 564 for the following:					
				GX100-564F	I-164-K
				GX100-564K	I-164-N
				GX100-564N	I-164-275
					I-164-KF25
					I-164-KF40

XGS-600 Gauge Controller

The Analog Input card has two channels and enables power and the display for all Agilent active gauges. The board is also compatible with many competitor gauges.

Table 2-4 Compatible Agilent Gauges

Agilent	Inficon	Leybold	MKS	Auto ID Code
PVG500/502	PSG500/502			PVG500
PVG550/552	PSG550/552			PVG500
PCG750/752	PCG550/552			PCG750
FRG700/702	MPG400/401			FRG700
FRG720/730	BPG400/402	ITR 90/ ITR 200		FRG720
CDG500	CDG025D	CRT100		CDG500
CT-100				CT-100
			622B, 623B, 626B, 722B	MKS CDG

Chapter 3: Operating Instructions

Operational Screens

Screen Flow

Figure 3-1 shows the screen flow.

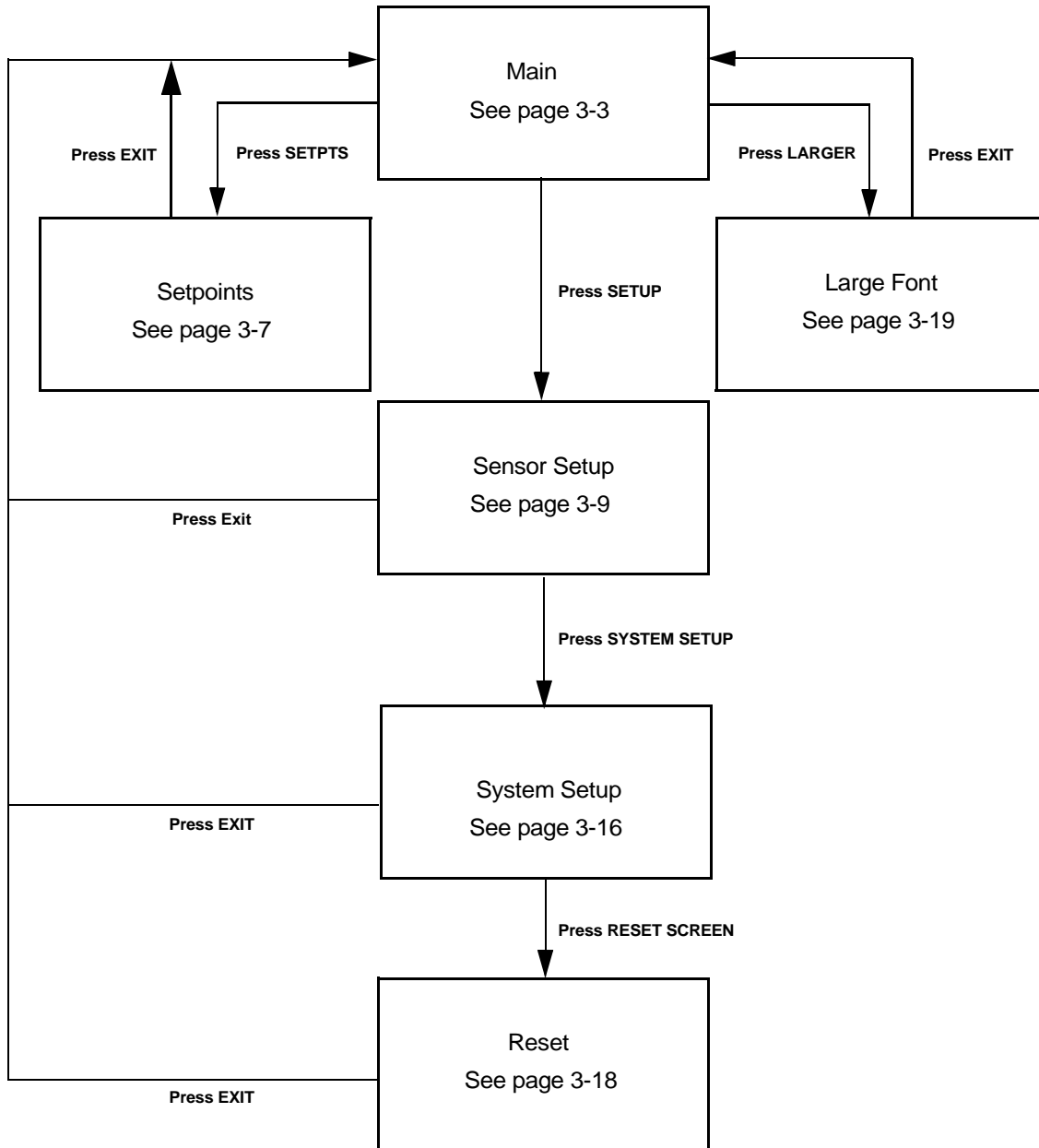

Figure 3-1 Screen Flow

General Navigation and Data Entry



Use navigation keys to locate cursor on an area of interest (ex. data entry, gauge control or screen navigation soft key). Only fields that are user-variable are accessible by the cursor. Hold the key pressed for faster cursor movement.



Press the + or - keys to increment/decrement the field value through all options. Hold the key pressed for fast increments/decrements.



Use the OK key to accept the selected option or data.

Examples:

Turning a gauge on:

- a. Cursor over to the control field for a gauge.
- b. Press + or - keys to view control options (ON, OFF, etc).
- c. Press **OK**.

Modifying a number:

- a. Cursor over to the number.
- b. Press + or - keys to increment/decrement number.
- c. Press **OK**.

Navigating to another screen:

- a. Cursor over to the screen navigation soft key (usually lower right corner of screen).
- b. Press **OK**.

NOTE



Escape keys: While scrolling through options or data using the +/- keys, you can escape without accepting new data by pressing any cursor navigation key. The original data is kept and displayed.

Main Screen

Figure 3-2 shows the main screen, which appears at power up.



The sequence of gauge rows follows the board installation sequence from left to right (when viewed from the front).

Use this screen to:

- ❑ View a list of installed sensors.
- ❑ View real-time pressure readings and status by sensor.
- ❑ Turn an ion gauge on/off or calibrate a Convection gauge.
- ❑ View the setpoint status.

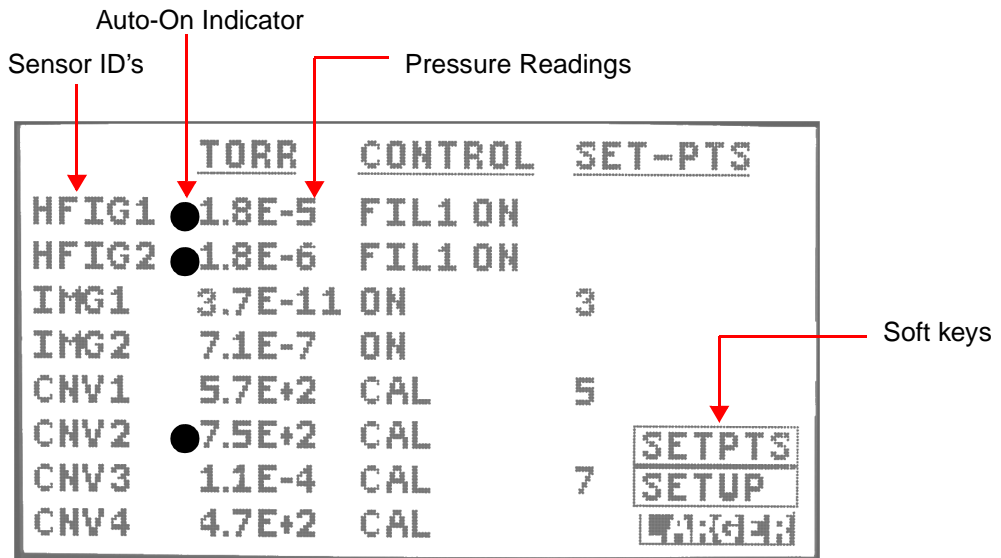

Figure 3-2 Main Screen

Soft Keys

- | | |
|--------|--|
| SETPTS | Select to open the Set Point screen (page 3-7). |
| SETUP | Select to open the Sensor Setup screen (page 3-9) and other setup screens. |
| LARGER | Select to open the Large Font screen (page 3-19). |



The NEXT key appears if there are more than eight gauges. Use this key to move to the next Main screen with the additional gauges.

XGS-600 Gauge Controller

Sensor ID's	Lists the five-character User Label configured on the "Sensor Setup Screen" on page 3-9.
Auto-On Indicator	<p>Indicates Auto-On has been set up, using the Sensor Setup screen, between a convection and an ion gauge(s). The same symbol appears next to both the convection and the ion gauge showing the link between the two.</p> <p>In the screen shown, convection gauge <i>CNV2</i> has been set up to trigger both ion gauges <i>HFIG1</i> and <i>HFIG2</i>.</p> <p>Multiple Auto-ON setups are possible, with a different symbol shape for each Convection gauge.</p> <p>See "Sensor Setup Screen" on page 3-9 for Auto-ON details.</p>
Pressure Reading	<p>Displays the gauge pressure reading. The pressure units, as selected in the System Setup screen, appear at the top of the column:</p> <ul style="list-style-type: none"><input type="checkbox"/> Convection gauge readings always appear, as they are always on.<input type="checkbox"/> Active gauge readings always appear as they are always on. The Active Gauge Card automatically recognizes the gauge type and display pressure reading.<input type="checkbox"/> For ion gauges,  appears when a gauge is first turned on, until the software determines a valid reading. <p>See Table 4-1 on page 4-6 for error messages displayed in this column.</p> <p>If an ion gauge error message appears in the pressure reading column and the control column indicates OFF, clear the error as follows:</p> <ol style="list-style-type: none">1. Press OK or reselect OFF in the control column.2. Scroll to ON option to turn the gauge on.

XGS-600 Gauge Controller

Control

Use this column to input operational commands to the system. The options available are:

Hot Filament Gauges:

- OFF
- FIL1 ON
- FIL2 ON
- DEGAS 1 ON (See section below)
- DEGAS 2 ON
- DEGAS OFF

Convection Gauges:

- CAL

Inverted Magnetron Gauges:

- OFF
- ON

Active Gauges with Analog Input Card:

- CAL

Degas (HFIG only):

To activate the DEGAS function, select **DEGAS1 ON** or **DEGAS2 ON** depending on which filament is currently on.

Emission has to be on before Degas starts, and the pressure reading must be below 1E-5T (or equivalent in other units). When Degas times out (approximately 25 minutes), the field reverts to *FIL1* or *FIL2*, whichever filament is in use.



Degas Limitations: All gauges operate simultaneously, but only two hot filament gauges can degas at the same time. Additional degasses are not allowed by the system.

To terminate degas manually, select **Degas OFF**. The field reverts to Fil1 or Fil2. Turning off degas momentarily turns off emission.

CAL (CNV and AUX):

Convection TC gauges and the CT-100, PVG500 and PCG500 are calibrated using this control. The XGS-600 uses Agilent's Smart Cal, which automatically determines whether to perform a vacuum calibration or atmosphere calibration based on the pressure presented to the sensor.

Active Gauges:

When using FRG700 or FRG720/730, pressing CAL only performs an atmosphere calibration. As determined by the Smart Cal feature.

When using CDGs, pressing CAL only performs an offset calibration (zeroing). As determined by the Smart Cal feature.



Convection gauge calibration at atmosphere depends on orientation. Be sure to install the gauge sensor in final orientation before calibrating.

To calibrate:

1. Cursor down to the CAL control for the required gauge.
2. Present either vacuum or atmospheric pressure to the gauge. (Allow the gauge to stabilize for 15 minutes after first power up.)
3. Press **OK**.

Vacuum calibration defaults to 1E-4T and atmosphere calibration defaults to 760T (or equivalents in mbar and Pa). See “System Setup Screen” on page 3-16 for modifying atmospheric pressure to your regional value. See “Sensor Setup Screen” on page 3-9 for selecting gas type. See “Convection Gauge Board” on page A-6 for activating the same calibration using rear-panel I/O controls, and “ASCII Serial Commands” on page B-1.

It is normal for the vacuum reading of Convectorr and TC gauges to fluctuate somewhat when at high vacuum after calibration. Typically, you can expect the readings to be anywhere from 1.0E-4 Torr to ~3.0E-4 Torr with an occasional reading as high as 1.0E-3 Torr (or equivalent mbar and Pa).

After performing *Cal for CDGs*, it is normal for *Under* to sometimes appear.

SET-PTS (Set Points)

Displays the setpoints activated. The setpoints are numbered on the Set Point screen (page 3-7).

The setpoint number appears if all following conditions met:

- The setpoint is assigned to the sensor,
- The setpoint screen is set to AUTO for that setpoint,
- And the setpoint has been activated.

XGS-600 Gauge Controller

Set Point Screen

To open this screen select **SETPTS** on the *Main* screen.

#	SETPT	ON&DELAY	OFF&DELAY	EXIT
1	HFIG1	3E-09 0.0	9E-08 0.0	OFF
2	HFIG2	8E-08 0.1	3E-06 2.0	AUTO
3	IMG1	7E-08 0.0	5E-07 0.0	AUTO
4	IMG2	2E-09 0.5	1E-08 0.1	AUTO
5	CNV1	6E+02 0.0	7E+02 0.0	AUTO
6	CNV2	1E-01 0.1	3E-01 1.3	AUTO
7	NONE	8E-02 0.2	1E+00 0.0	OFF
8	CNV4	1E-02 1.0	1E-01 5.0	ON

Figure 3-3 Set Point Screen

- Set Point #** This number corresponds to the sequence of eight rear panel Set Point outputs. This is also the number that appears on the *Main* screen if the setpoint is activated. These are fixed numbers and not user changeable.
- SETPT** Select an available gauge in this list to assign to a Setpoint #. Only two set points are allowed per sensor. If two setpoints are already assigned to a sensor, that sensor does not appear in the list of options for this field.
- NONE is available as a choice. If selected, all pressures and delays are set to zero and OFF.
- ON** Select a Setpoint On pressure value. If the sensor pressure falls below this value, the rear panel open collector output activates (voltage low). The relay output *NO* contact connects to the common contact, and the Setpoint # appears on the Main screen next to that sensor. The ON reading must be a lower pressure than the OFF reading or an error (ERR) warning appears in the rightmost column. Once valid settings are entered, *ERR* changes to *AUTO*.
- See “XGS-600 Gauge Specifications” on page A-1 for setpoint output specifications and setpoint connector pin-outs. For other application information, see page A-2.
- ON DELAY** If a delay is required between the time the sensor detects the Setpoint ON pressure value and the outputs activates (rear panel, Main screen indicator and serial communication), select a delay time in seconds. Example: A setting of 1.2 results in a delay of approximately 1.2 seconds.

XGS-600 Gauge Controller

OFF	Select a Setpoint OFF pressure value. If the sensor pressure rises above this value, the rear panel output de-activates (voltage high) and the Setpoint # clears from the Main screen. The OFF reading must be a higher pressure than the ON reading or an error (ERR) warning appears in the rightmost column. Once valid settings are entered, ERR changes to AUTO.
OFF DELAY	If a delay is required between the time the sensor detects the Setpoint OFF pressure value and the output, de-activates (rear panel, Main screen indicator and serial communication), select a delay time in seconds. Example: A setting of 1.2 results in a delay of approximately 1.2 seconds.
AUTO/ON/OFF	Options include: <ul style="list-style-type: none"><input type="checkbox"/> AUTO indicates the setpoint state is determined by comparing the pressure to the setpoint limits. This is the default setting and is used to enable the setpoint.<input type="checkbox"/> OFF and ON are override values, which can also be used for manual testing. Selecting OFF or ON does not clear pressure/time settings.
EXIT SOFT KEY	Select to return to the main screen (page 3-3).

Sensor Setup Screen

To open this screen select **SETUP** on the Main screen.

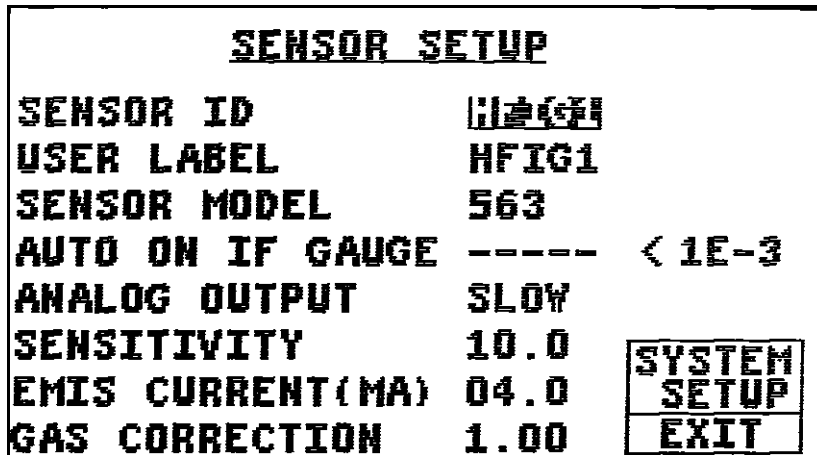

Figure 3-4 Sensor Setup Screen: HFIG and IMG Sensors

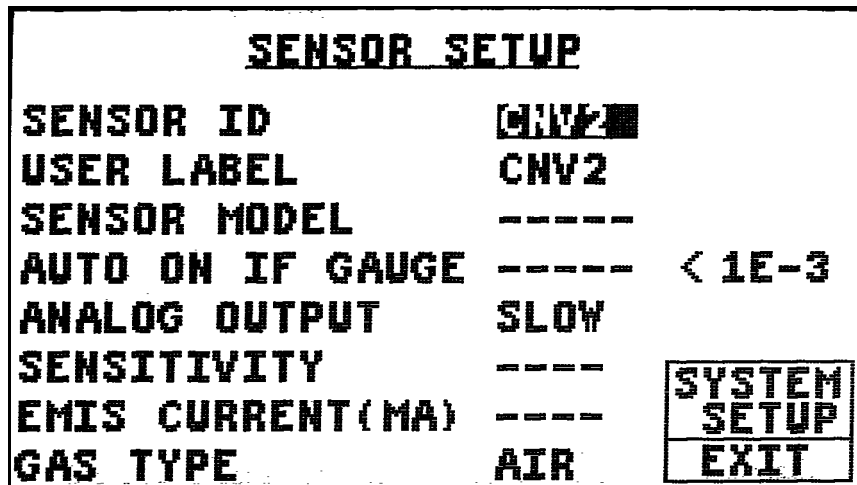

Figure 3-5 Sensor Setup Screen: CNV (Convection) Sensors and Active Gauges Sensor

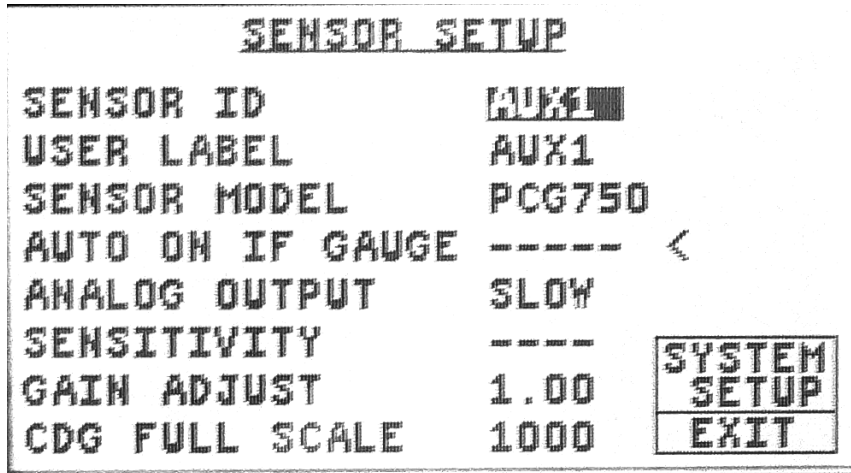

Figure 3-6 Sensor Setup Screen: Analog Card

See Table 3-1 on page 3-11 for default values. Fields that are unavailable have - - -.

Sensor ID Use this field to select the sensor to view its setup parameters. Displays the unique system-assigned gauge identification. Scroll through this list to select a sensor and the remainder of fields on the screen populate with its present settings.

Possible sensor ID's are:

- HFIGx for Hot Cathode Ion Gauge boards using BA or UHV sensors.
- CNVx for Convection boards (TC/ConvecTorr)
- IMGx for IMG Gauge boards
- AUXx for Analog Input Boards (Active Gauges)

where x indicates the number of the transducer attached. The number is system-assigned based on the sequence of board installation, left to right (when viewed from the front). Convection boards have two sensors per board. When more than 4 convection boards are installed, the 10, 11, and 12 channels are designated CNVA, CNVB, and CNVC, respectively.

User Label Use this field to enter your label for this sensor that appears on all other screens and serial communication. This field has a maximum of five (5) characters and any alphanumeric character is available for use.

User Labels that begin with HFIG, CNV, IMG or AUX are not allowed to avoid confusion with Sensor ID's.

If no User Label is selected, the default is the Sensor ID. When a System Reset is initiated, this label is reset to the sensor ID.

XGS-600 Gauge Controller

Sensor Model

Use this field to configure the particular model of sensor attached to a board.



If Sensor Model is changed, all fields resort to default values. The Analog Input Card automatically recognizes the active gauge type and indicates the Sensor Model.



When using the CT-100 with the Analog Card, SETPT2 must be set fully to the VAC position or the gauge is not recognized.

Table 3-1 Default Setup Values by Ion Gauge Type

HFIG Sensor Model	Default Emis Current (ma)	Default Sensitivity	Over-pressure limit (mT)+	Default Degas Power (mA)	Number of Filaments
MBA100	0.1	25	1-10*	1	1
MBA200	0.1	25	1-10*	1	2
571	4	10	1-10*	10	1
572	4	10	1	10	2
563	4	10	1-10*	10	1
564	0.1	6	1-10*	10	1
UHV24 (default)	4	25	1	10	2
UHV24p	4	20	1	10	2
IMG 100 (default)	N/A	2.0	10 (Hi Voltage stays ON)	N/A	N/A
IMG 300	N/A	2.5	10 (Hi Voltage stays ON)	N/A	N/A

+ Not a user-variable setup parameter

* If Emission Current is set:

- Less than 0.7 mA, overpressure is 10 mT (or equivalent in mbar or Pascal).
- Greater than 0.7 mA, overpressure is 1 mT (or equivalent in mbar or Pascal).

XGS-600 Gauge Controller

AUTO-ON IF GAUGE	<p>This field is active for HFIG and IMG gauges only. Use this field along with < (is less than) to select a Convection, Active or CDG gauge and assign a pressure level below which AUTO-ON engages.</p> <p>When Auto-On is activated, you cannot manually turn on or off the ion gauge; it is controlled by the assigned convection gauge. Select - - - to deactivate Auto On.</p>
< (is less than)	<p>Use this field with Auto-ON to enter pressure (max allowed 1T) at which to trigger the ion gauge. There is a hysteresis of 5mT built in to the software to prevent fluctuating ion gauge emission from triggering on/off. For example, if this field is set to 3E-3T, Auto-ON turns on the ion gauge at 3E-3T and off at 8E-3T.</p>
ANALOG OUTPUT	<p>Use this field to select either the FAST or SLOW analog output. Select:</p> <ul style="list-style-type: none"><input type="checkbox"/> FAST and the output is updated every 10 msec.<input type="checkbox"/> SLOW and the update is every 250 msec. <p>The default setting is FAST for the IMGs, SLOW for hot filament and rough gauges.</p>
SENSITIVITY	<p>This field is active for HFIG and IMG gauges only. Use this field to raise or lower the sensitivity.</p>
EMIS CURRENT (mA)	<p>This field is active for HFIG gauges only. Use this field to configure the EMIS Current. See Table 3-1 on page 3-11 for sensor default values.</p>
<div style="display: inline-block; vertical-align: middle;"><p style="text-align: center;">NOTE</p></div>	<p><i>Changing the Sensor Model, defaults Sensitivity and Emission Current settings.</i></p> <p><i>Use this to calibrate full scale CDG readings or to scale readings.</i></p>
GAS CORRECTION	<p>(HFIG and IMG gauges) Use this field to enter a correction for various gas types. For an ion gauge, enter a nominal value from Appendix D “Gas Correction Factor Table”.</p>
GAS TYPE	<p>(Convection gauges) Use this field to enter a gas type by name. Select <i>Air</i>, <i>Argon</i> or <i>Helium</i> (“Helium Measurement Capability” on page 3-14).</p>
CDG FULL SCALE	<p>Sets the full scale reading for the CDG display.</p>
SYSTEM SETUP	<p>Select to open the System Setup screen (page 3-16).</p>
EXIT	<p>Select to return to the Main Screen (page 3-3).</p>

Selecting Emission Current for Hot Filament Ion Gauges

When the gauge model number is selected, the XGS-600 automatically selects a default emission current value that works for most applications. However there are reasons why you may want to select another value based upon your application.

- ❑ If you are using a gauge at pressures higher than $1.0\text{E-}4$ Torr, the gauge performs better and lasts longer at low values of emission current. In general, for this pressure range, use 0.1 ma.
- ❑ If you are using the gauge in the UHV range, the default emission setting may not result in a large enough ion current to measure reliably. In this case, increase the emission current to the maximum setting of 10 ma. However, there will be more out-gassing which could adversely affect the system pressure. So, a compromise between the emission current setting and filament out-gassing must be made. Try to use the lowest emission current setting that provides good measurement results.
- ❑ If you have had your gauge calibrated, it would have been done at a specific emission current. You should enter that value into the emission current setting of the XGS-600.
- ❑ The XGS-600 employs a feature that automatically changes the emission current based on the pressure that is measured. If the emission current is set to values greater than or equal to 1.1 ma, the controller applies the full value when the measured pressure is below $1.0\text{E-}5$ Torr, and $1/10^{\text{th}}$ of that value when the pressure is above that level. There is an algorithm to minimize hunting. However, depending upon the vacuum system, it may still be possible for the gauge to hunt for the proper emission current setting when at or near $1\text{E-}5\text{T}$. This is caused by the fact that when the emission current is raised as the pressure goes down, the filament outgases at a higher rate, causing the pressure to increase a bit. Sometimes it is possible for the pressure to increase enough that the controller reduces the emission current, which eliminates the source of gas. This causes the pressure to decrease to where the controller again raises the current, and the system can get stuck in this cycle. You can defeat this by setting the emission current to 1.0 ma or less, so the XGS-600 maintains that constant emission current at all pressures.

HFIG Smart Overpressure Protection

Hot filament ion gauges all exhibit non-linearity at high pressure such that they give readings lower than the actual pressure. For gauges that are rated up to 10 mTorr or higher, operating the BA gauge at low emission current can minimize this measurement error. Unfortunately, many applications require operating the gauge at emission currents that would result in poor measurement accuracy at high pressure, thereby compromising the ability to provide effective overpressure protection.

XGS-600 Gauge Controller

XGS-600 adjusts the overpressure limit based upon the emission current. When the emission current is 0.7ma or less, the gauge's full high pressure range can be used. If, however, the emission current is set to higher values, XGS-600 protects the gauge by turning off the filament at 1 mTorr. Overpressure Protection uses the same fast pressure signal that is used for fast set points, and is displayed by the *P>MAX* error message.

Setting the Auto-ON Pressure Level

When enabling the Auto-ON feature, the XGS-600 defaults the threshold pressure to 5 mTorr. If the convection gauge is installed so that it is measuring the same high vacuum chamber as the ion gauge, this is a good value to use. However, in many applications users may want to monitor the high vacuum pump's fore-line pressure instead. In this application, the foreline may never get down as low as 5 mTorr, especially if a large volume of gas is being pumped. The XGS-600 allows you to program a threshold pressure as high as 1 Torr. When Auto-ON is being used, the gauge overprotection feature is still active to protect the high vacuum gauge.

When the Analog Board is installed, any of the active type gauges, or CDGs, can be used to turn on/off an ion gauge.

Helium Measurement Capability

Helium has been added to Air and Argon selections in *Gas Correction* in the *Gauge Setup* screen for roughing gauges. This selection allows the controller to read correctly when the predominant gas is helium. However, it is important to recognize the performance limitations of heat loss gauges when used with helium. These are:

- ❑ Poor performance above 200 Torr - The signal to noise ratio at this high pressure range is very small, therefore stability, resolution, and accuracy are much worse than a direct pressure gauge such as a CDG, silicon diaphragm gauge, or even a bourdoin tube. Repeatability and drift is typically several hundred Torr. Performance below 200 Torr is about the same as when measuring in air.
- ❑ The maximum cable length is about half that when measuring air or argon. The maximum recommended cable length using standard cables is 150'.
- ❑ The maximum number of rough gauge channels is reduced. Every gauge channel setup for helium is equivalent to two channels when set for air or argon. Therefore, the maximum number of convection cards, if all are set to helium, is three (six channels).

Selection of Analog Output Response Time

The *Gauge Setup* screen now has a line for selecting between a FAST or SLOW analog output response time. When FAST is selected, the analog output response time is ~10 msec, while the SLOW selection is ~ 250 msec. The original XGS-600 release was always slow. The fast mode is useful for applications where you want to log and inspect the events that lead up to a fast set-point release or if they want to use the analog output for their own interlock purposes and bypass the XGS-600 set point outputs. When the fast response time is selected, the signal is necessarily somewhat noisier and less accurate than the slow version.

The default settings are FAST for the IMGs and SLOW for hot filament, rough gauges and gauges connected to the analog board.

System Setup Screen

Use this screen to set values for overall system operation.

To open this screen select **SYSTEM SETUP** on the Sensor Setup screen.

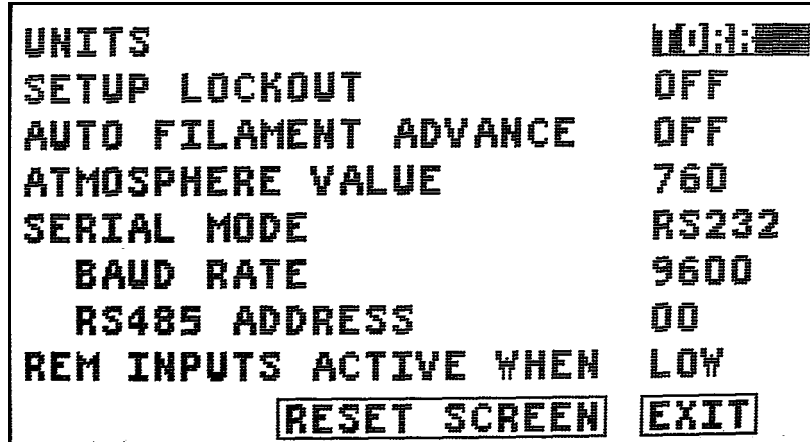

Figure 3-7 System Setup Screen

UNITS	Select: Torr (default), Pascal or mbar. Once the units are changed, the values throughout the system are updated to the new units.
SETUP LOCKOUT	Toggle this to ON to make all fields on the SYSTEM SETUP and SENSOR SETUP screen display-only (except for this field). This provides a layer of security to prevent inadvertent changes.
AUTO FILAMENT ADVANCE (HFIG Boards)	For two-filament HFIG sensors, if Auto Filament Advance is selected, Filament 2 is automatically engaged if Filament 1 has an open filament error (NO FIL1). FIL2 ON then appears on the main screen. Auto filament advance can occur when emission is first turned on or during gauge operation. Auto advance does not advance from Filament 2 to Filament 1. If an open filament error occurs on Filament 2, instead the NO FIL2 error appears and emission is turned off.

XGS-600 Gauge Controller

ATMOSPHERE VALUE (Convection Boards)	Sets the Atmosphere value to be used in Convection gauge calibration. See “Main Screen” on page 3-3 for the calibration procedure.
SERIAL MODE	Select between RS232 and RS485 communications. When RS232 or RS485 is selected, the communication protocol is ASCII (see “ASCII Serial Commands” on page B-1) and the only difference being the use of either the RS232 or RS485 transceivers. With the XGS-600 BCD communication is a <i>packed-BCD</i> type using only the RS232 transceiver. This protocol is described in “BCD Serial Commands” on page C-1 and is substantially backwards compatible with older Multigauge controllers running Px.x EPROMs.
SERIAL BAUD RATE	Selects between baud rate options: 9600 (default) and 19200.
RS485 ADDRESS	Set the RS485 address (default 00) as used in the first two characters of all serial protocol commands (see “ASCII Serial Commands” on page B-1).
REMOTE INPUTS ACTIVE WHEN	Use this to select either active LO (default) or active HI logic for the HFIG and IMG board on-off and degas (HFIG only) inputs. When the input is in the active state, the gauge is turned on. The active HI selection provides backwards compatibility with Multigauge and Sentorr applications. See “XGS-600 vs MultiGauge and SenTorr Backwards Compatibility Detail” on page A-13 for a description of differences.
RESET SCREEN	Select to open the Software Versions screen which includes the system reset function (page 3-18).
EXIT	Select to return to the Main Screen (page 3-3).

Notes on Serial Communications

There are three selections for serial communications:

- RS232
- RS485
- BCD (requires the XGS-600 BCD model)

The RS232 and RS485 modes are ASCII protocols. Refer to Appendix B “ASCII Serial Commands” for the list of commands and the command protocol. These are largely backwards compatible with Multigauge using software revisions Ax.x (ie: A2.4 for example) and all Sentorr controllers.

The pins for RS232 and RS485 are contained in the same connector housing. See Appendix A “XGS-600 Gauge Specifications” for the pin specifications.

XGS-600 Gauge Controller

The BCD selection is a so-called *packed-BCD* protocol that was used on older Multigauge controllers using software revisions Px.x (ie: P3.3 for example).



Sentorr never used the BCD protocol.

This protocol can only use the RS232 transceiver and is intended for applications that require the XGS-600 to operate in older systems, where it is impossible to modify the system's software. While this provides enhanced backwards compatibility with most applications, due to differences between the Multigauge and XGS-600 controllers it cannot guarantee backwards compatibility with **ALL** applications. See Appendix C "BCD Serial Commands" for the list of commands and command protocols.

Software Versions Screen

This screen shows the software versions on a board-by-board basis.

To open this screen select **RESET SCREEN** on the System Setup screen.

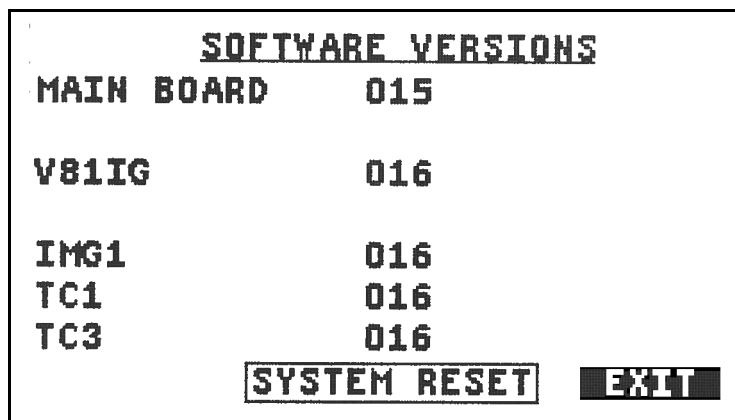

Figure 3-8 Software Versions Screen

SYSTEM RESET Use this to perform a full reset of user-defined variables, reverting the system to as-shipped (factory-set) state.

EXIT Select to return to the Main Screen (page 3-3).

Large Font Screen

To open this screen select **LARGER** on the Main screen.

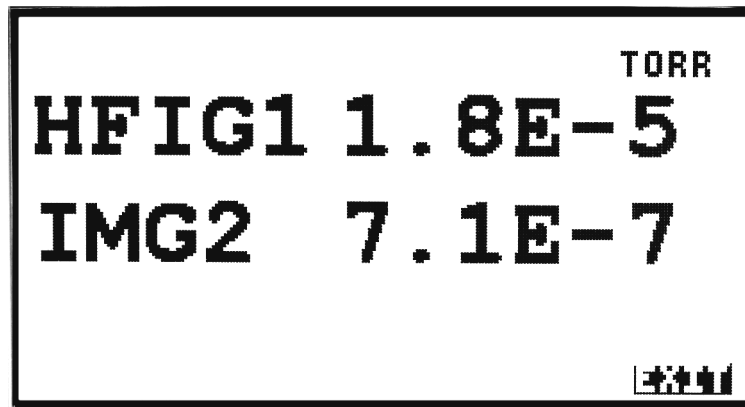

Figure 3-9 Large Font Screen

The leftmost column shows the User Label as configured on the Sensor Setup screen. You can select which transducers appear on this screen by moving the cursor to the User Label and using the +/- modify keys.

EXIT Select to return to the Main Screen (page 3-3).

This page intentionally left blank.

Chapter 4: Service and Troubleshooting

It is possible to replace sensor boards in the field for repair or to change the unit's configuration to meet new application requirements. Because the slot spacing is different for slots 5 & 6, you must follow the instructions below when installing the sensor boards.

Board Configuration Rules

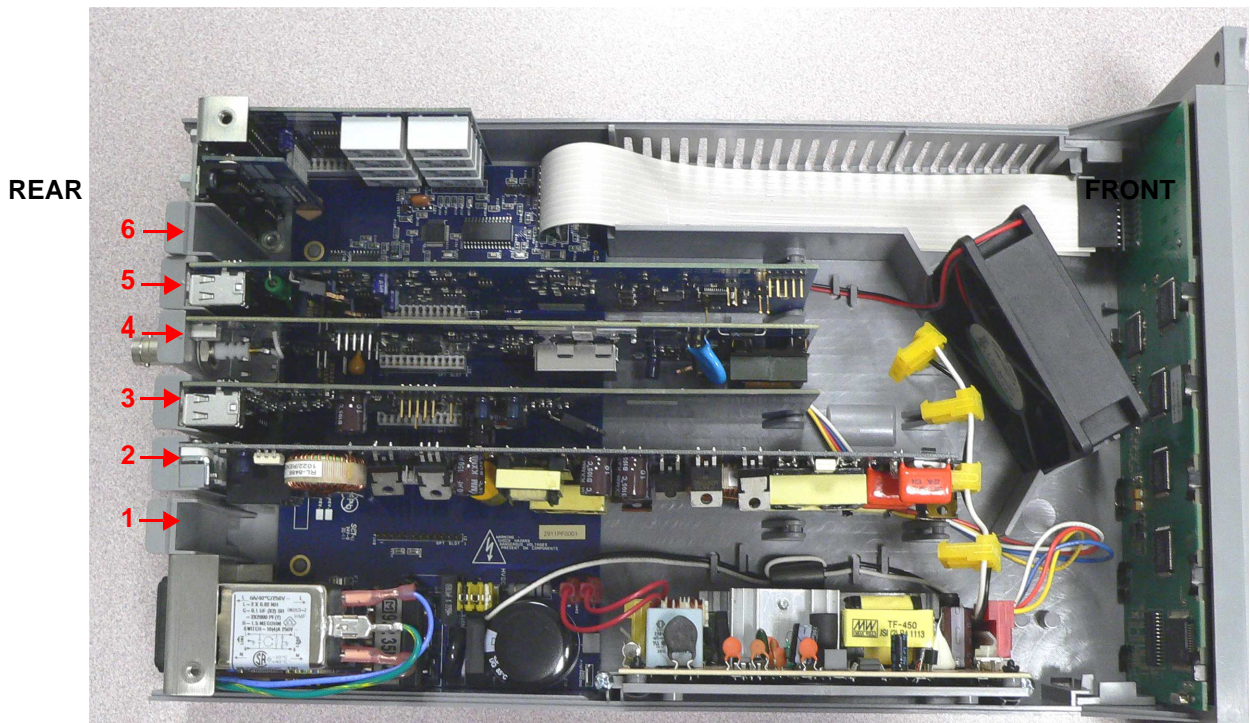

Figure 4-1 XGS-600 Slot Numbers

- ❑ Slots are numbered from left to right as viewed from the front of the XGS-600.
- ❑ Option slots 1 through 4 are “Long, High Profile Slots” and can accommodate any board. HFIG boards are “Long, High Profile” boards and can only be installed in slots 1 through 4.
- ❑ Option slots 5 and 6 are “Short, Low Profile” slots and can accommodate only analog, convection or IMG boards, with the following restrictions:
 - An IMG board may NOT be installed in slot 5 if any other board is installed in slot 4.
 - An IMG board may NOT be installed in slot 6 if any other board is installed in slot 5.

XGS-600 Gauge Controller

Examples:

- ❑ You want to install 5 IMG boards:
 - IMG boards are installed into slots 1, 2, 3, 4, and 6. Slot 5 remains empty. Do not install any board into slot 5.
- ❑ You want to install 4 IMG and 2 CNV boards:
 - IMG boards are installed in slots 1, 2, 3, and 4; CNV boards are installed in slots 5 and 6.

Sensor Board Replacement Procedure

WARNING



Only trained service personnel should attempt this work. Disconnect the XGS-600 mains connection by unplugging the IEC power cord from the back of the unit before removing the unit's cover.

CAUTION



Wear an ESD bracelet and observe all appropriate precautions to avoid damage to PCBs.

CAUTION



When these boards are assembled certain components are bent over intentionally. Do not straighten them.

1. Turn off and unplug the line cord (AC mains).
2. Remove the cover by unscrewing the two Philips head screws.
3. If removing an HFIG board, unplug the yellow connector near the front panel. It may require some effort to unplug. Do not pull on the wires, pry the yellow plastic connector instead.

XGS-600 Gauge Controller

- Lift the sensor board by the tab at the rear panel (Figure 4-2). Once the board is disengaged from the board connector, pull the board out of the end guide.

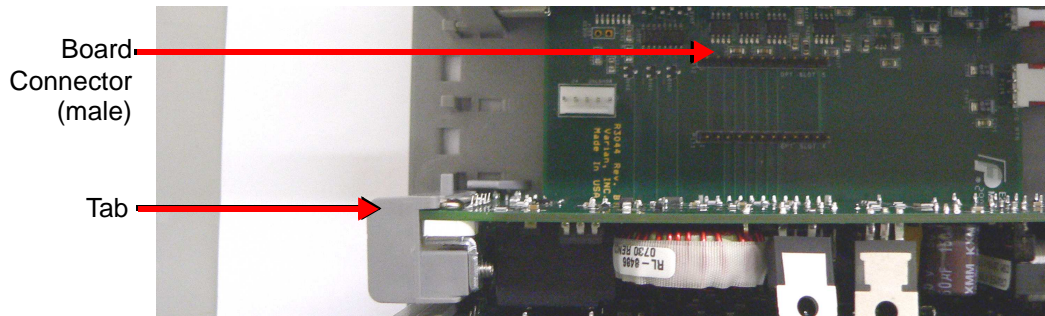

Figure 4-2 Tab and Main Board Connector

WARNING



To ensure safety and proper operation, no slot opening can be left unfilled. Install a filler plate by installing the two hooks into the case bottom and snapping in the foot. Contact Agilent if additional fillers are needed.

- Install the replacement board:
 - Place the end of the board into the end guide (Figure 4-3).

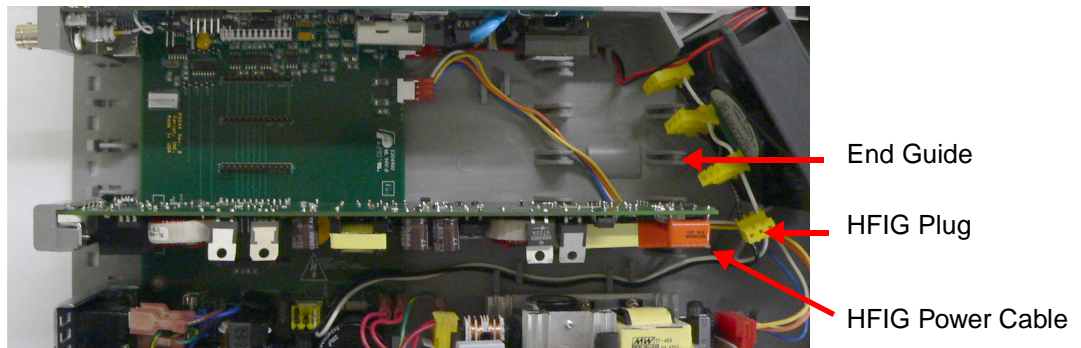

Figure 4-3 End Guide and HFIG Connector

- Guide the board down as straight as possible onto the connector on the main board. Figure 4-4 shows the connector on the base of all three board types.



Figure 4-4 Sensor Board Connector: Bottom View

XGS-600 Gauge Controller

- c. Locate the rear panel portion of the board into its slot, press down the tab and exert gentle pressure until it clicks into place.

CAUTION



Do not force the board down. If too much pressure is required the connector pins are not aligned.

- d. Insert the yellow HFIG plug into the connector (HFIG boards only). See Figure 4-3. This connector is keyed.
 - e. Inspect the installation to ensure the board is seated properly and not touching any adjacent boards.
6. Replace the covers:
 - a. Push the cover straight in under the lip at the XGS front bezel.
 - b. Replace the two Philips head screws.
 - c. The cover must be flat and fully seated. It may be necessary to adjust the boards and filler plates slightly for the cover to fully engage. The cover should drop on front of the filler plate.
 7. Plug the unit back in and turn on the power switch.

NOTE



Any board-specific settings must be reprogrammed.

Most Sensor setup and Set point user settings stay with the board. This means if the removed board is used elsewhere, most settings will be saved. However, if a new board is installed, you will have to reprogram the settings.

Mains Fuse Replacement Procedure

WARNING



Only trained service personnel should attempt this work. Disconnect the XGS-600 mains connection by unplugging the IEC power cord from the back of the unit before removing the unit's cover.

WARNING



Replace the mains fuse only with the same type and electrical ratings (250V, 5A, FAST-BLO, 5x20mm).

1. Turn off and unplug the line cord (AC mains).
2. Remove the cover by unscrewing the two Philips head screws.

XGS-600 Gauge Controller

3. Locate the mains fuse under the IEC input module and replace (Figure 4-5).

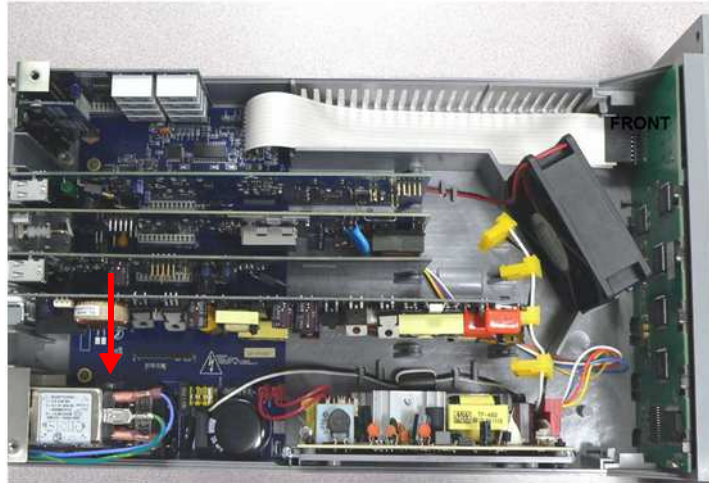

Figure 4-5 Fuse Replacement

4. Replace the cover by:
 - a. Pushing the cover straight in under the lip at the XGS front bezel.
 - b. Replacing the two Philips head screws.
 - c. Ensuring the cover is flat and fully seated. It may be necessary to adjust the boards and filler plates slightly for the cover to fully engage. The cover should drop on front of the filler plate.
5. Plug the unit back in and turn on the power switch.

Troubleshooting

Error Codes

Table 4-1 General Error Codes

Error Message	Meaning	Cause	Action
<i>BD COM</i>	Board Comm: Internal communication error	Motherboard and sensor board stopped communicating	1. Cycle power to unit 2. Return unit for repair
<i>GRIDLO</i> (HFIG bds only)	Grid voltage is too low	<input type="checkbox"/> Pressure is too high causing a glow discharge <input type="checkbox"/> HFIG board failure	1. Check BA gauge for grid to filament short or grid to housing short 2. Replace gauge
<i>HITEMP</i> (HFIG and IMG bds only)	Internal temperature is above 75° C	<input type="checkbox"/> Fan failure <input type="checkbox"/> XGS ventilation openings blocked <input type="checkbox"/> Internal temperature above 75° C	1. Allow unit to cool 2. Check that fan is operating 3. Ensure that there is adequate ventilation around the unit
<i>NOFIL1</i> (HFIG bds only)	Filament is open or cable disconnected	<input type="checkbox"/> Filament failure <input type="checkbox"/> Ion gauge cable not connected	1. Use second filament 2. Replace BA gauge 3. Check that cable is installed
<i>NOFIL2</i> (HFIG bds only)	Second filament is open or cable disconnected	<input type="checkbox"/> Filament failure <input type="checkbox"/> Ion gauge cable not connected	1. Replace BA gauge 2. Check internal sensor board connections 3. Check that cable is plugged in
<i>Open</i> (CNV bds only)	No Convection sensor detected	<input type="checkbox"/> Cable not connected <input type="checkbox"/> Sensor failure	1. Check cable 2. Replace sensor
<i>P>MAX</i> (HFIG bds only)	Pressure is above the maximum operating point for the gauge	<input type="checkbox"/> System vented from vacuum with gauges on <input type="checkbox"/> Attempted to turn gauges on with vacuum near overpressure limit	1. Turn gauges off before venting system or use AUTO-ON 2. Wait for vacuum to improve before turning on ion gauges
<i>No CBL</i> (Analog boards only)	No active gauge cable detected	<input type="checkbox"/> Cable not connected to XGS-600	1. Check cable

XGS-600 Gauge Controller

Table 4-1 General Error Codes (Continued) (Continued)

Error Message	Meaning	Cause	Action
<i>Fault</i> (Analog boards only)	Active gauge voltage < 0.5 V	<input type="checkbox"/> Gauge defective <input type="checkbox"/> Cable defective <input type="checkbox"/> Gauge drifted	1. Check cable 2. Check active gauge Replace if necessary
<i>Under</i> (Analog boards only)	CDG voltage negative or below previous VAC CAL	<input type="checkbox"/> CDG has drifted	1. Press CAL 2. Readjust zero at CDG

Tips

Agilent offers reference ionization B/A gauges, which are sealed off at approximately 5E-6 Torr/6.6E-4 Pa, as well as a Convection gauge simulator which can switch between atmosphere and vacuum simulation. These devices are extremely helpful in troubleshooting a vacuum system problem by isolating the defective component.



These reference gauges and stimulators are not NIST traceable calibrated gauges, and should not be used for calibration.

Troubleshooting Table

Table 4-2 Troubleshooting

Problem	Cause	Action
Hot filament gauge <i>hunts</i> or <i>cycles</i> around 1E-5Torr (1E-3Pa)	Auto emission adjustment occurs at this pressure. Increased filament power causes a rise in pressure. Condition will clear as system pressure decreases.	If taking pressure measurements in this range, reduce emission current setting for the gauge to 1.0 mA or less to turn off feature
IMG displays readings in the -11 Torr range when the pressure is known to be higher Sometimes after a long time period the reading becomes correct	<input type="checkbox"/> IMG cable not plugged in <input type="checkbox"/> IMG has not started <input type="checkbox"/> IMG took a long time to start	1. Check that cable is attached 2. Sometimes IMG's are hard to start when turned on at high vacuum 3. Raise pressure 4. Clean or replace IMG

XGS-600 Gauge Controller

Table 4-2 Troubleshooting (Continued)

Problem	Cause	Action
HFIG bd reads UHV when pressure is know to be higher	<ul style="list-style-type: none"> <input type="checkbox"/> Emission current not established due to worn out Th-Ir filament <input type="checkbox"/> Collector cable unplugged <input type="checkbox"/> HFIG board failure 	<ol style="list-style-type: none"> 1. Check collector connection at gauge (glass BA) and at XGS-600 2. Replace gauge or filament 3. Return unit for repair/replace HFIG bd
<i>ERR</i> appears in rightmost column of setpoint screen	Setpoint OFF pressure is < than ON pressure	Correct pressure entries so the setpoint ON pressure is less than the OFF pressure
<i>Duplicate</i> message appears when trying to enter a User Label	<input type="checkbox"/> Label is the same as another User Label	Create a different entry
User Label not accepted	<input type="checkbox"/> User input violates User Label rules	See "Sensor Setup Screen" on page 3-9 for User Label rules
Cannot turn HFIG or IMG on using the keypad	<ul style="list-style-type: none"> <input type="checkbox"/> Auto-ON programmed for that gauge <input type="checkbox"/> The keypad is locked out 	<ol style="list-style-type: none"> 1. This is the correct response 2. If manual control is desired, turn off AUTO-ON 3. Unlock keypad
Cannot turn on Degas	<ol style="list-style-type: none"> 1. Pressure is above 1E-5T 2. Attempted to turn on Degas2 while running Fil1 3. Attempted to degas third gauge 	<ol style="list-style-type: none"> 1. Pump down before degas 2. Change operation to Fil2 before attempting to degas that filament 3. XGS-600 will only degas two gauges at a time 4. Finish a degas before attempting to start a third
The front panel display indicates the setpoint triggers/releases at a slightly different pressure than what is programmed	Time delay = 0.0, 0.1	XGS-600 uses a less accurate pressure measurement for setpoint delays of <= 0.1 secs to obtain the fastest response
Changes to baud rate, comm. mode, units, keypad lockout, or ATM value do not take effect	Did not exit System Setup screen after making changes	After making changes, exit the screen for the changes to take effect

XGS-600 Gauge Controller

Table 4-2 Troubleshooting (Continued)

Problem	Cause	Action
Unit does not respond to RS232 or RS485 commands	<ol style="list-style-type: none"> 1. XGS600 in wrong serial mode or incorrect baud rate 2. Incorrect wiring 3. Incorrect terminal settings 	<ol style="list-style-type: none"> 1. Change serial comm to RS232 or RS485, select proper baud rate, set RS485 address in <i>General Setup</i> screen 2. Check wiring 3. Check that terminal has correct # of data, start/stop bits, etc.
Display goes blank followed by a refill of the screen. Operation is otherwise normal.	Screen refreshes approximately every 5 seconds	XGS-600 refreshes the entire screen periodically to update. No action required.
One or more ion gauge channels (HFIG and IMG) appear to restart, sometimes a <i>BDCOMM</i> message appears first	A major EMI disturbance or other anomaly has caused a sensor board watchdog timeout	This is how the XGS-600 recovers from hard and soft errors. No action required.
<i>BDCOMM</i> message appears on one or more channels and stays	A major EMI disturbance or other anomaly has caused a non-recoverable software error	Cycle AC (mains) power to the unit OFF and ON again to recover
IMG reads 10 mT	Pressure is greater than 10 mT	Wait for pressure to drop into operating range or use Auto-On feature to control IMG
Display goes blank	A major EMI has caused a display or software error	Cycle AC (mains) power to the unit OFF and ON again to recover, or wait for the automatic screen refresh (every 20 minutes)
Convection or TC readings fluctuate when first at HI VAC but then quiet down	This is normal behavior of the Convectorr and TC gauges when doing a pumpdown.	None
Convection or TC readings fluctuate in excess of 1 mT continuously when at Hi VAC	Possible defective gauge.	Replace gauge
Convection or TC readings unstable at atmosphere when measuring Helium	This is normal performance for thermal loss gauges in helium	Refer to "Helium Measurement Capability" on page 3-14 for performance limits when measuring helium

This page intentionally left blank.

Appendix A. XGS-600 Gauge Specifications

Instrument Specifications

Table A-1 provides the XGS-600 instrument specifications.

Table A-1 General XGS-600 Gauge Specifications

Specification	Description
Display	Type: Backlit dot matrix monochrome LCD Backlight: White LED Small Font mode: Up to 8 channels displayed simultaneously Large Font mode: Up to 2 channels displayed, readable from 15 feet
Keypad	5 button membrane with positive tactile feedback
Serial Communication	ASCII protocol: RS232 and RS485, no parity BCD protocol: RS232 RS485 address range: 00 - FF Baud Rate: 9600 or 19600
Open-Collector Set-Point Outputs	Type: 8 open collector type, ground referenced outputs Voltage Rating: 32 VDC max Current Rating: 50 mA max Output Voltage: V_{out} To Gnd $V_{on} @ 5 \text{ mA} = 0.6 V_{max}$ $V_{on} @ 25 \text{ mA} = 0.75 V_{max}$ $V_{on} @ 50 \text{ mA} = 0.90 \text{ V}$ Programming capability: Can assign up to 2 outputs per gauge channel Separate <i>make</i> and <i>break</i> pressure levels Independent time delays on <i>make</i> and <i>break</i> of 0.0 to 9.9 seconds Manual override capability of each set point output Response Time: 20 msec max (when delay = 0.0)

XGS-600 Gauge Controller

Table A-1 General XGS-600 Gauge Specifications (Continued)

Specification	Description
Relay Set-Point Outputs	<p>Electromagnetic relay Form C</p> <p>Voltage Rating: 30 VDC max</p> <p>Current Rating: 2 A DC max</p> <p>Contact Resistance:</p> <ul style="list-style-type: none"> <input type="checkbox"/> 50 mOhms - contacts are nickel, silver, gold plated <p>Programming capability:</p> <ul style="list-style-type: none"> <input type="checkbox"/> Can assign up to 2 outputs per gauge channel <input type="checkbox"/> Separate <i>make</i> and <i>break</i> pressure levels <input type="checkbox"/> Independent time delays on <i>make</i> and <i>break</i> of 0.0 to 9.9 seconds <input type="checkbox"/> Manual override capability of each set point output <p>Response Time:</p> <ul style="list-style-type: none"> <input type="checkbox"/> Make: 30 msec max <input type="checkbox"/> Break 40 msec max
Chassis	<p>Dimensions: ½ rack, 2U high, 11" deep</p> <p>Material: Grey Polycarbonate</p> <p>Ventilation: Internal fan with plenum and over-temperature sensing</p>
Fuse Rating	250V, 5A, FAST-BLO, 5x20mm
Mains Power and Cordage	<p>Voltage: 100-120, 200-240 VAC ±10% 50/60 HZ, 2A</p> <p>Available worldwide IEC cords</p>
Environmental/Installation	<p>Storage Temperature: -15 to 70° C</p> <p>Operating Temperature: BV certified 5 to 40° C, at 5 to 95% RH, non-condensing</p> <p>Installation Category: 2</p> <p>Pollution Degree: 2</p> <p>Indoor use</p> <p>Altitude: Up to 2000 m</p>

XGS-600 Gauge Controller

Table A-1 General XGS-600 Gauge Specifications (Continued)

Specification	Description
Regulatory Approval	CE Certified: Safety: EN61010 Emissions: EN6100-3-2 : 2006 EN6100-3-2 : 2005 EN61326: 1997/A1: 1998/A2: 2001/A3: 2003 EN55011 FCC Part 15 subpart J Certified to CSA1010 for US and Canada RoHS Compliant WEEE labeled

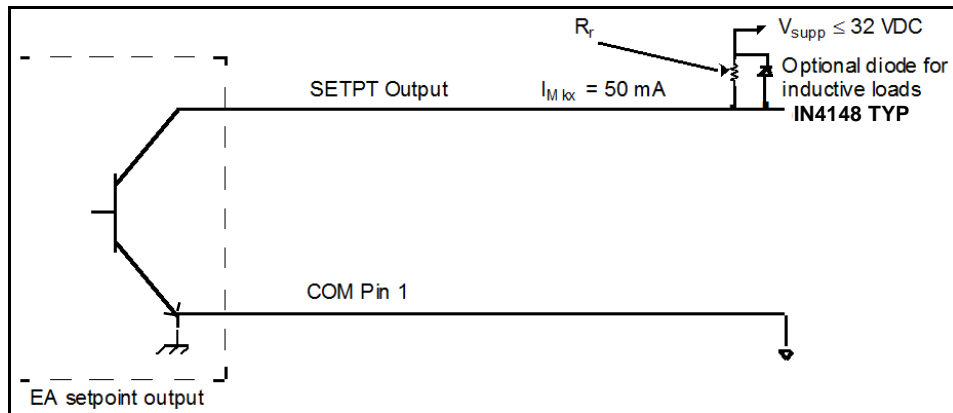

Figure A-1 Open Collector Setpoint Equivalent Circuit

When the setpoint is:

- Off, no current flows into the transistor and the output voltage equals V_{supp} .
- On, current flows into the transistor and the output voltage will be near ground. See Table A-1 for a specification of this voltage as a function of current.

XGS-600 Gauge Controller

Interfacing to a PLC requires that the PLC logic input sources current (Figure A-2).

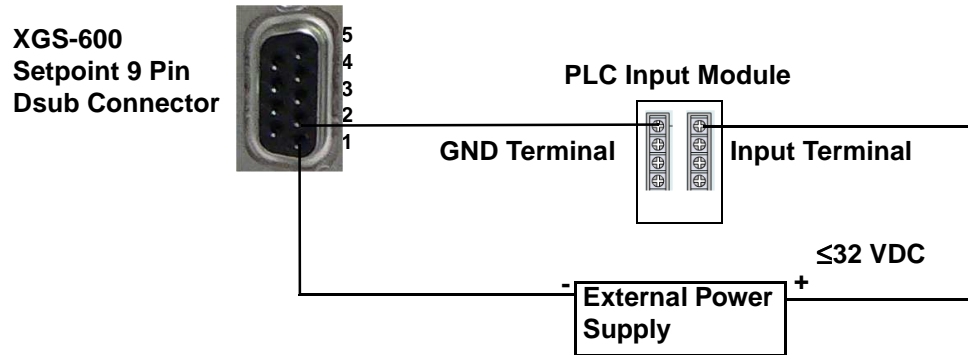

Figure A-2 PLC Input Module Current Configuration

Board Specifications/Descriptions

HFIG Board

The HFIG board operates all Agilent hot filament gauges and most other available Bayard-Alpert type hot filament ionization gauges including nude UHV types. The board can be set up for all Agilent hot filament gauges and allows you to set gauge emission current, sensitivity value, and gas correction factor. The UHV range and E-Beam degas are standard, as is dual filament control, remote I/O control of emission and filament selection, and 0 to 10 V analog output.

Table A-2 HFIG Gauge Specifications

Item	Description
Supported Gauge Heads	<input type="checkbox"/> Agilent 563, 564, 571, 572, UHV24, UHV24p, MBA-100, MBA-200
Displayed Measurement Range*	<input type="checkbox"/> 5.0E-12 Torr to 1 mTorr (UHV24, UHV24p, 572) <input type="checkbox"/> 5.0E-11 Torr to 10 mTorr (563, 571, MBA100, MBA200) * This represents the ability of the controller to display pressure values and not the capability of the gauge heads to accurately measure pressure.
Emission Current	0.1 to 10.0 mA
Sensitivity Input Range	00.1 to 99.9/Torr
Gas Correction Factor Range	0.01 to 9.99
Degas	E-Beam type, 600 V at 10 mA, enabled only when pressure is below 1.0E-05 Torr. Pressure indications displayed during degas. Automatic shutoff after approximately 25 minutes, or manual shutoff.
Analog Output	<input type="checkbox"/> Range: 0-10 VDC <input type="checkbox"/> Slope: 1 V per decade log <input type="checkbox"/> Characteristic: output voltage = Log (Pressure) + 11 <input type="checkbox"/> Output when gauge OFF or Error = 10V <input type="checkbox"/> Load Impedance: >10 kOhms <input type="checkbox"/> Response Time: <input type="checkbox"/> SLOW - 250 msec <input type="checkbox"/> FAST - 10 msec
Error Detection	<input type="checkbox"/> Open Filament <input type="checkbox"/> Shorted Grid <input type="checkbox"/> Over Temperature <input type="checkbox"/> Over Pressure (1mT or 10mT dependant on tube type selected)
Gauge Connector	<input type="checkbox"/> Collector: SMB coax <input type="checkbox"/> Fil and Grid:AMP 5 pos Univ Mate-N-Lok

XGS-600 Gauge Controller

Table A-2 HFIG Gauge Specifications

Item	Description
Remote I/O	<ul style="list-style-type: none"> <input type="checkbox"/> Connector: 6 pin IEEE 1394 (Firewire type) <input type="checkbox"/> Inputs for Emission on/off and DEGAS on/off are user selectable to be either Active LO or Active HI. Driving the input to the active state turns on that function. <ul style="list-style-type: none"> <input type="checkbox"/> HI = +5 V max, 2.4 V min <input type="checkbox"/> LO = 0.8 V max, 0 V min <input type="checkbox"/> Filament Select input: Pin 1 open or driven HI selects Fil1. Pin 1 grounded selects Fil2. <input type="checkbox"/> Status Output goes HI during error condition <input type="checkbox"/> Analog Output
Allowable Cable Length	<ul style="list-style-type: none"> <input type="checkbox"/> up to 50' using Agilent standard cable <input type="checkbox"/> up to 300' using under 10' Agilent standard cable + Agilent extension cable

Convection Gauge Board

The Convection card operates two Thermocouple/Convection gauges and allows you to calibrate:

- To the actual atmospheric pressure value,
- To vacuum pressure,
- and select calibration for air or argon.

Calibration is Agilent's *Smart Cal* that determines whether a CAL command is for vacuum or atmosphere. Remote control of calibration and analog output is standard. Each channel has its own 9-pin Dsub connector.

Table A-3 Convection Board Specifications

Item	Description
Supported Gauge Heads	Agilent Model, 536, 531, and ConvecTorr
Displayed Measurement Range	1.0E-4 Torr to 1000 Torr
Gas Types	Air, Argon or Helium (see "Helium Measurement Capability" on page 3-14)
Atmosphere Value Range	500 to 1000 Torr

XGS-600 Gauge Controller

Table A-3 Convection Board Specifications

Item	Description
Analog Output	<input type="checkbox"/> Range: 0-10 VDC <input type="checkbox"/> Slope: 1 V per decade log <input type="checkbox"/> Characteristic: output voltage = Log (Pressure) + 4 <input type="checkbox"/> Output when gauge OFF or Error = 10 V <input type="checkbox"/> Load Impedance: >10 kOhms <input type="checkbox"/> Response Time: <input type="checkbox"/> SLOW - 250 msec <input type="checkbox"/> FAST - 10 msec
Error Detection	Open cable/sensor
Gauge Connector	Dsub9 (female)
Remote I/O Connector	6 pin Firewire type Grounding the input pin activates that function The Status Output goes hi during an error. Note: the analog outputs for CNV1 and CNV2 are also available at pin 7 of their respective Dsub connectors.
Allowable Cable Length	<input type="checkbox"/> Air/Argon - up to 300 ' using Agilent TC or Convectorr cable <input type="checkbox"/> Helium - up to 150' using Agilent TC or Convectorr cable

IMG Board

The IMG board operates Agilent IMG-100 and IMG-300 gauges and allows you to set gauge sensitivity value, and gas correction factor. The UHV range is standard, as is remote I/O control of emission and 0 to 10 V analog output.

Table A-4 IMG Board Specifications

Item	Description
Supported Gauge Heads	Agilent IMG-100, IMG-300
Measurement Range*	1.0E-12 to 1.0E-02 Torr * (or equiv mbar and Pa) * This represents the ability of the controller to display pressure values and not the capability of the gauge heads to accurately measure pressure.
Sensitivity Input Range	00.1 to 99.9
Gas Correction Factor Range	0.1 to 9.9

XGS-600 Gauge Controller

Table A-4 IMG Board Specifications (Continued)

Item	Description
Analog Output	<ul style="list-style-type: none"> <input type="checkbox"/> Range: 0-10 VDC <input type="checkbox"/> Slope: 1 V per decade log <input type="checkbox"/> Characteristic: output voltage = Log (Pressure) + 11 <input type="checkbox"/> Output when gauge OFF or Error = 10 V <input type="checkbox"/> Load Impedance: >10 kOhms <input type="checkbox"/> Response Time: <ul style="list-style-type: none"> <input type="checkbox"/> SLOW - 250 msec <input type="checkbox"/> FAST - 10 msec
Error Detection	Over Temperature
Gauge Connector	SHV
Remote I/O Connector	<ul style="list-style-type: none"> <input type="checkbox"/> Connector: 6 pin IEEE 1394 (Firewire type) <input type="checkbox"/> Input for Emission on/off is user selectable to be either Active LO or Active HI. Driving the input to the active state will turn on the gauge. <ul style="list-style-type: none"> <input type="checkbox"/> HI = +5 V max, 2.4 V min <input type="checkbox"/> LO = 0.8 V max, 0 V min <input type="checkbox"/> Status Output goes HI during error condition <input type="checkbox"/> Analog Output
Allowable Cable Length	up to 300' using RG59U

Analog Input Board

The Analog Input board operates all Agilent Active Gauges and many other Active Gauges types. The boards allow you to calibrate:

- To the actual atmospheric pressure value (CT-100, PVG, PCG, FRG series)
- To vacuum pressure (CT-100, PVG, PCG series) of 1×10^{-4} Torr or equivalent Pa, mbar.
- To Zero adjust (CDG series)

I/O Pin Assignments

Table A-6 through Table A-11 give the I/O pin assignments for the various boards and connectors.

Table A-6 IMG Board I/O Pin Assignments

Function	Pin # (J26)
EMIS ON	6
ANALOG OUT	5
STATUS OUT	4
GND	2 + Shield
-	1
-	3

Table A-7 HFIG Board I/O Pin Assignments

Function	Pin # (J26)
EMIS ON	6
ANALOG OUT	5
STATUS OUT	4
GND	2 + Shield
FIL 2 SELECT INPUT	1
DEGAS ON INPUT	3

Table A-8 Convection and Analog Board I/O Pin Assignments

Function	Pin # (J1)
CH1 ANALOG OUT	5
CH2 ANALOG OUT	3
EXT CH1 CAL IN	1
EXT CH2 CAL IN	6
STATUS OUT	4
GND	2 + Shield

XGS-600 Gauge Controller

Table A-9 Set-Point Connector Pin Assignments

Function	Pin #
GND	1
SET POINT 1 OUTPUT	2
SET POINT 2 OUTPUT	3
SET POINT 3 OUTPUT	4
SET POINT 4 OUTPUT	5
SET POINT 5 OUTPUT	6
SET POINT 6 OUTPUT	7
SET POINT 7 OUTPUT	8
SET POINT 8 OUTPUT	9

Table A-10 Relay Connector Set-Point vs. Terminal Pin Assignments

Setpoint Number	Pin #		
	C	NC	NO
1	1	2	14
2	3	15	16
3	4	17	5
4	6	18	19
5	7	9	20
6	8	21	22
7	10	11	23
8	13	24	25

Table A-11 Serial Connector Pin Assignments

Function	Pin #
+RS485 XFD (DIFF INPUT/OUTPUT)	1
TXD OUTPUT RS232	2
RXD INPUT RS232	3
NOT USED	4

XGS-600 Gauge Controller

Table A-11 Serial Connector Pin Assignments

Function	Pin #
GND	5
NOT USED	6
NOT USED	7
RTS OUTPUT RS232	8
-RS485 XFD (DIFF INPUT/OUTPUT)	9

Table A-12 Analog Input Board Connector Pin Assignments

Function	Pin #
+15 V out (MKS CDG)	5
-15 V out (MKS CDG)	4
Spare	3
Sig Ret	2
Pwr Gnd	1
Signal In (0-10 V)	9
Gauge ID	8
Cable Detect	7
+24 V	6

XGS-600 vs MultiGauge and SenTorr Backwards Compatibility Detail

XGS-600 replaces both MultiGauge and SenTorr rack mount controllers. While the XGS-600 was designed to be substantially backwards compatible, there are some design features that prevent the new product from being 100% backwards compatible.

Backwards Compatible Features

There are three board options, they are:

- Hot Filament Ion Gauge Board (HFIG)
- Inverted Magnetron Board (IMG)
- Two channel Convection Board (CONV)

The *Hot Filament board* replaces both the UHV and BA MultiGauge boards and implements the SenTorr BA and UHV models. You select the type of sensor being employed and software takes care of the settings. The ion gauge cable connectors are identical to the older products.

The *Inverted Magnetron* board employs the same SHV connector as MultiGauge and operates both of the IMG100 and the IMG300 (UHV-IMG) as does the current MultiGauge board.

The *Two Channel Convection board* has the same gauge cable connectors as the current MultiGauge Convection card, and the SenTorr xxTC and xx2C models. MultiGauge uses the Dsub connector for the analog output, as well as for the sensor connections, and this is supported in XGS-600.

The RS232 serial communications connector and protocol is supported in XGS-600, as well. However, the RS485 connection is now housed in the same Dsub-9 connector as for the RS232, and is not backwards compatible with the MultiGauge and SenTorr Mini-DIN connectors.

Relay board, Dsub 25, however, maximum number of two setpoints per channel.

Non-Backwards Compatible Features

The significant changes with the XGS-600 vs MultiGauge and SenTorr are the following:

- XGS-600 does not have a 4 channel TC card (MG)
- The analog outputs are housed in a firewire type connector (as mentioned above, the two channel Convection board has its analog outputs in the Dsub's as well)
- Remote I/O signals are also housed in the same fire-wire connector. There is no I/O board option as in MultiGauge
- The standard non-isolated open-collector set-point outputs are housed in a 9-position Dsub connector. All eight NO outputs share a single ground connected

XGS-600 Gauge Controller

common pin. SenTorr used terminal block connectors while MultiGauge used a 25-position Dsub. XGS-600 does not provide terminal blocks.

- ❑ The standard relay outputs are housed in a 25-position Dsub connector using the same pinout as MultiGauge, provide NO and NC contacts, where only two setpoints per channel can be assigned. These contacts are not rated for switching AC mains voltages.
- ❑ XGS-600 is not available in a *Black Box* version with a remote mountable display.

Table A-13 list the features compatible for the MultiGauge and SenTorr units.

Table A-13 Feature Compatibility Table

Feature	XGS-600	MultiGauge	SenTorr BA or UHV	SenTorr CC
Hot Filament Gauges	All	All	All	n/a
Cold Cathode Gauges	IMG100 IMG300 (UHV-IMG)	IMG100 UHV-IMG 525CCG	n/a	525CCG
Convection Gauges	2 ch Convection Bd using (2) Dsub9	4 ch TC Bd using Dsub37 2 ch ConvecTorr Bd using (2) Dsub9	2 ch ConvecTorr using (2) Dsub9 2 ch TC	2 ch ConvecTorr using (2) Dsub9 2 ch TC
CDG's	Analog Input Board	(2) Dual Ch CDG Bds	n/a	n/a
Rem I/O	Uses Fire-wire conn on each board Emission/degas control inputs can be user selected to be active LO (default) or active HI. CNV CAL inputs are active LO. Logic levels are std TTL logic, +5V max input.	Needs optional Remote I/O Bd using Dsub37 Uses opto-isolated active HI inputs 32V max	Micro phone jack for IG control Uses opto-isolated active HI inputs 32V max	Micro phone jack for IG control Uses opto-isolated active HI inputs 32V max
Analog Output	In Fire-wire conn of each Bd Conv Bd also provides access pin in Dsub9	Micro phone jack on each Bd 2ch and 4ch Conv bds provide access in Dsub conn	Micro phone jack	Micro phone jack

XGS-600 Gauge Controller

Table A-13 Feature Compatibility Table (Continued)

Feature	XGS-600	MultiGauge	SenTorr BA or UHV	SenTorr CC
Set Points	<ul style="list-style-type: none"> <input type="checkbox"/> Std 8 set-points, 2 per ch using open collector drivers in Dsub9 for fastest response <input type="checkbox"/> Std 8 set-points, 2 per ch using relays using Dsub 25 access to C, NO, NC contact 	Optional 8 setpoints using relays using Dsub25, access to C,NO,NC contacts	Optional 4 setpoints using relays using term block type conn, access to C,NO,NC contacts	Optional 4 setpoints using relays using term block type conn, access to C,NO,NC contacts
RS232	Std Dsub9 IBM pinout, supports MG protocol	Opt Dsub9, IBM pinout	Opt Dsub9, IBM pinout	Opt Dsub9, IBM pinout
RS485	Std in Dsub9, supports MG protocol	Opt with choice of daisy chain using MiniDIN or Dsub9	Opt with choice of daisy chain using MiniDIN or Dsub9	Opt with choice of daisy chain using MiniDIN or Dsub9
BCD (RS232)	Supports older MG Px.x serial protocol applications XGS-600 BCD only	Px.x EPROMs	N/A	N/A
<i>Black Box</i> and Remote Display option	No	No	Yes	Yes

XGS-600 Gauge Controller

Table A-14 list the cable compatibility for the MultiGauge and SenTorr units.

Table A-14 Cable Compatibility Table

Cable	XGS-600	MultiGauge	SenTorr BA or UHV	SenTorr CC
UHV Bakeable L6440	Yes	Yes	Yes	N/A
UHV non-bakeable L6441	Yes	Yes	Yes	N/A
Glass BA L6455	Yes	Yes	Yes	N/A
Ion Gauge Extension L6456	Yes	Yes	Yes	N/A
525 CCG L5671*	No	Yes	n/a	Yes
IMG R0341, R0311	Yes	Yes	n/a	No
MBA R1172	Yes	Yes	Yes	n/a
Quad/Dual TC L6475*	No	Yes	No	No
Single TC L9131	Yes	Yes	Yes	Yes
Single Conv L9122	Yes	Yes	Yes	Yes
CDG L9153	No	Yes	No	No

* Adapters are available

Appendix B. ASCII Serial Commands

Response to serial command inquiries approximately 10 ms, response time defined as time between receipt of last query character to transmission of first response character. Serial queries more frequent than 10 per second will compromise system responsiveness.

Command Syntax and Definitions

The command format is:

{XGS-600 address} {command number} {optional data} {carriage return}

The response format is:

> {optional data} {carriage return}

The following characters are used in Table B-1:

Command	Description	Notes
#		All commands to the XGS-600 must begin with the character #.
aa	RS485 Address	=00 for RS232 (system default). Max allowable: 20hex
01	Command Number	Each command is identified by a unique command number, 2 hex digits, 01-FF.
c	Sensor Code	=U, signifies User Label is to follow.
n	User Labels	As found on Sensor Setup screen. Examples: #00B0UION4UGATE3.2E-03 sets AUTO-ON for ion gauge <i>ION4</i> using CNV gauge <i>GATE</i> . #0030UGATE1 turns on emissions of sensor User Label Gate1. #0055UTOP26.00 sets sensitivity for ion gauge with User Label Top. Note: If User Label is not defined by user, default User Label is Sensor ID.
Note: Alternatively, <i>cn</i> can be used to designate a short code instead of User Label, backward compatible to Multi-Gauge/SenTorr protocol; see separate instructions below (Table B-1 on page B-2)		
h	Hex Digit	Used to identify setpoint number or to list status of 8 bits.

XGS-600 Gauge Controller

Command	Description	Notes
x	Data Digit	
< CR >	Termination	All commands sent to the XGS-600 require < CR > termination. < LF > is ignored so it is possible to use < CR/LF > with RS232 but not with RS485 as it would cause a collision with the response. Please note that time to response is extremely quick (10 to 20 ms) so be ready! Responses are also terminated with < CR >.

The XGS-600 sends *?FF* as a response if the command or data is invalid, or if the command length is incorrect. There is no response to a wrong address, or lack of termination character.

Table B-1 Serial Command Set

Description	Command	Response from XGS-600	Notes
Read XGS contents	#aa01	>hhhhhhhhhh where <i>hh</i> sensor board codes are: 10 = Hot Filament Ion Gauge board (HFIG) 3A = Inverted Magnetron board (IMG) 40 = convection board (CNV) = Analog Board 4C FE = Empty slot	Lists two-character codes identifying the 6 board slots in the system, following board installation sequence from left to right (front view).
Read pressure	#aa02cn	>x.xxxE-xx	
Read software revision	#aa05	>hhhh,hhhh . . . where <i>hhhh</i> represents revision hh.hh	Revisions shown for main board, then each sensor board following board installation sequence from left to right (front view).
System Reset	#aa06	>	
Read Pressure Dump	#aa0F	>x.xxxE-xx,x.xxxE-xx, . . .	All sensor readings in one command. Readings follow board installation sequence from left to right (front view).

XGS-600 Gauge Controller

Table B-1 Serial Command Set (Continued)

Description	Command	Response from XGS-600	Notes
Set pressure units to Torr	#aa10	>	
Set pressure units to mBar	#aa11	>	
Set pressure units to Pascal	#aa12	>	
Read pressure units	#aa13	>xx where: xx = 00 is Torr xx = 01 is mBar xx = 02 is Pascal	
Assign User Label to Sensor	#aa14cnLABEL where c sensor code =I for ion gauges HFIG and IMG =T for CNVs + AUXs n = Sensor Count counting TCs or ion gauges from left to right from the front panel view. LABEL= user-defined 1-5 characters.	>	Label can be any 5 or fewer characters (AHZ, 0-9, or space), except for IMGxx, HFIGx, CNVxxx and AUXxxx, (where x is any character) which are reserved.
Read User Label of Sensor	#aa15cn	>LABEL where LABEL is user-defined 1-5 characters.	If no User Label is assigned, defaults to system-assigned Sensor ID.
Setup Lockout OFF	#aa20	>	
Setup Lockout ON	#aa21	>	
Read Setup Lockout status	#aa22	>xx where: xx = 00 is OFF xx = 01 is ON	
Set Auto-On	#aaB0cn1cn2x.xE-xx where cn1 is the Ion Gauge and cn2 is the TC.	>	

XGS-600 Gauge Controller

Table B-1 Serial Command Set (Continued)

Description	Command	Response from XGS-600	Notes
Read Auto-On	#aaB1cn where cn is Ion Gauge.	>cnx.xExx where cn is the TC.	
Ion Gauge Commands (HFIG and IMG gauges)			
Assign Tube Type to Sensor (only HFIG and IMG boards)	#aa16cnxx where xx = 11 for IMG100 (default) 13 for IMG300 51 for MBA100 52 for MBA200 63 for 563 64 for 564 71 for 571 72 for 572 80 for UHV24 (default) 81 for UHV24p	>	
Read Sensor Tube Type (only HFIG and IMG boards)	#aa17cn	>xx where xx = 11 for IMG100 (default) 13 for IMG300 51 for MBA100 52 for MBA200 63 for 563 64 for 564 71 for 571 72 for 572 80 for UHV24 (default) 81 for UHV24p	
Set Emission OFF	#aa30cn	>	
Set Emission ON (Fil 1)	#aa31cn	>	Also used for single-filament gauges.
Read Emission status	#aa32cn	>xx where: xx = 00 is OFF xx = 01 is ON	
Set Emission ON (Fil2)	#aa33cn	>	

XGS-600 Gauge Controller

Table B-1 Serial Command Set (Continued)

Description	Command	Response from XGS-600	Notes
Read Filament Lit	#aa34cn	>xx where: xx = 01 is Filament 1 xx = 02 is Filament 2	
Set Auto Fil Advance Off	#aa35	>	
Set Auto Fil Advance On	#aa36	>	
Read Auto Fil Advance State	#aa37	>xx where: xx = 00 is OFF xx = 01 is ON	
Set degas OFF	#aa40cn	>	
Set degas ON	#aa41cn	>	
Read degas status	#aa42cn	>xx where: xx = 00 is OFF xx = 01 is ON	
Read ion gauge gas correction	#aa50cn	>x.xxx	
Set ion gauge gas correction	#aa51cnx.xxx	>	
Read Emission current	#aa52cn	>x.xxx	Least significant two digits always zero.
Set Emission current	#aa53cnx.xxx	>	Least significant two digits will be ignored.
Read Sensitivity	#aa54cn	>xx.xx	Always reads in Torr. Least significant digit is always zero.

XGS-600 Gauge Controller

Table B-1 Serial Command Set (Continued)

Description	Command	Response from XGS-600	Notes
Set Sensitivity	#aa55cnxx.xx	>	<p>This sensitivity value <u>must always be in Torr</u> due to xx.xx format restriction. Note however the value displayed on front panel is in Torr, mbar, or Pascal.</p> <p>Least significant digit will be ignored.</p> <p>Note: Will overwrite any factory setting.</p>
Setpoint Commands			
Read Setpoint States	#aa03	>00hh where hh is a hex value where each bit represents setpoints 1 - 8 and value 0=Off, 1=On	Setpoint numbers correspond to the numbers on the Setpoint screen.
Read assigned setpoints	#aa04cn	>00hh where hh is a hex value where each bit represents setpoints 1 - 8 and value 0=Not assigned, 1=Assigned	
Set Setpoint OFF/ON/Auto	#aa5Ehx where h is setpoint number 1-8 and x is state: 0 = OFF (manual override) 1 = ON (manual override) 3 = Auto (based on pressure) Example: #005E83 sets setpoint #8 to Auto.	>	

XGS-600 Gauge Controller

Table B-1 Serial Command Set (Continued)

Description	Command	Response from XGS-600	Notes
Read Setpoint OFF/ON/Auto	#aa5Fh where h is setpoint number 1-8	>x where x is state: 0 = OFF (manual override) 1 = ON (manual override) 3 = Auto (based on pressure)	
Set Setpoint On pressure level	#aa6hcnx.xxxE-xx where h is setpoint number 1-8	>	
Set Setpoint ON Delay time	#aaChx.x where h is setpoint number 1-8 and x.x is delay in seconds. C is part of the hex command number. Example: #00C31.2 sets on delay to 1.2 seconds for setpoint # 3	>	Setpoint must first be assigned to a sensor using setpoint screen or command 6h.
Set Setpoint Off pressure level	#aa7hcnx.xxxE-xx where h is setpoint number 1 - 8	>	Setpoint ON level must be set before OFF level.
Set Setpoint Off Delay time	#aaDhx.x where h is setpoint number 1-8 and x.x is delay in seconds	>	Setpoint must be assigned to a sensor.
Read Setpoint On pressure level	#aa8h where h is setpoint number 1 - 8	>x.xxxE-xx	
Read Setpoint ON Delay time	#aaEh where h is setpoint number 1-8	>x.x where x.x is delay in seconds	
Read Setpoint Off pressure level	#aa9h where h is setpoint number 1 - 8	>x.xxxE-xx	

XGS-600 Gauge Controller

Table B-1 Serial Command Set (Continued)

Description	Command	Response from XGS-600	Notes
Read Setpoint Off Delay time	#aaFh where h is setpoint number 1 - 8	>xx where x.x is delay in seconds	
AUX and CNV Commands			
Calibrate	#aaA1cn where cn is a CNV or AUX	>	This command has the same function as CAL on the main screen, i.e. used for both atmosphere and vacuum calibrations.
Set Atmosphere Value	#aaA3x.xxxE+xx where pressure is local atmospheric value.	>	Same as System Setup screen Atmosphere Value.
Read CNV gas type (CNV only)	#aa4Ecn	>x where: x=0 for Nitrogen/Air x=1 for Argon	
Set CNV gas type (CNV only)	#aa4Fcnx where: x=0 for Nitrogen/Air x=1 for Argon	>	

NOTE

All alpha characters must be upper case.



Notes to owners of Multi-Gauge and SenTorr:

- ❑ Most commands used by Multi-Gauge and SenTorr are still found in this protocol.
- ❑ Commands which apply to Multi-Gauge/SenTorr but do not apply to the XGS are ignored by the XGS-600. There is no response and no error message.
- ❑ Any commands (ex. # 56-59) referring to a gauge or sensor type that is not supported by the XGS-600 result in ?FF error message.

XGS-600 Gauge Controller

Backward-compatible sensor code can still be used in XGS-600 as with Multi-Gauge/SenTorr protocol:

Command Entry	Description	Notes
c	Sensor Code	=T for TC/CNV = I for ion gauge (HFIG or IMG) Case sensitive.
n	Sensor Count	Counting TCs or ion gauges from left to right from the front panel view. Example: #003013 turns on the third ion gauge.

Using HyperTerminal

To see if communication has been established use a terminal emulator program like ProComm or Windows 3.xx Terminal or Hyperterminal.

- Use the recommended pre-made cinch cable type MDC-6 Pxx w/mini-Din connector.

Windows HyperTerminal Set-Up Instructions

1. Click **Start**.
2. Select *Programs > Accessories > Communications > HyperTerminal*.
3. Double-click **Hypertrm.exe**. The *Connection Description* dialog box appears.
4. Enter a name and choose an icon for the connection, for example: XGS-600 RS-232.
5. Click **OK**. The *Connect To* dialog box appears.
6. Select a COM port from the *Connect Using*; the pull-down list. The *Com Properties/Port Setting* dialog box appears.
7. Configure the following settings:
 - Bits per second (baud rate) – **9600** or **19200**, whichever is set on XGS-600.
 - Data bits: – **8**
 - Parity: – **None**
 - Stop bits: – **1**
 - Flow Control: – **None**
8. Click **OK**.
9. Select **Properties** from the *File* menu. The *Properties* window appears.
10. Configure the following settings on the *Connect To* tab:
 - Connect using – Verify the COM port is correct.

XGS-600 Gauge Controller

- Click **Configure** and verify the port settings are correct.
11. Ensure that the *Settings* tab is configured as follows:
- Terminal keys radio button selected.
 - Ctrl+H radio button selected.
 - Auto detect selected from the Emulation pull-down list.
 - ANSI entered in the Telnet terminal ID.
 - 500 set in the Background buffer lines field.
12. Click **ASCII Set-Up**. The *ASCII Set-Up* dialog box appears.
13. Ensure that the settings are as follows:
- Line delay – **0 milliseconds**
 - Character delay – **0 milliseconds**
 - ASCII Receiving – **Wrap lines that exceed terminal width**
- The cursor begins blinking.
14. Type some simple commands and see if there is a response:
- #0001
 - #0005
 - #000F

Appendix C. BCD Serial Commands

The response time to serial command inquiries is approximately 10 msec and is defined as the time between receiving the last query character to transmission of the first response character. Serial queries occurring more frequently than 10 per second will compromise system responsiveness.

C.1 Command Format

- ❑ The data format consists of a start bit (logic 0), 8 data bits, and a stop bit (logic 1). There is no parity bit.
- ❑ All commands are one byte commands that apply to the whole unit or are followed by one or more bytes to indicate the gauge the command is operating (Card Information Byte) and the desired pressure or parameter setting, if necessary.
- ❑ If an invalid command is received the XGS600 returns a one byte response of FFh.
- ❑ If a command is not completely received within approximately 5 seconds, the XGS600 ignores the command in process and expect a fully new command.
- ❑ In all of the following, the suffix *H* indicates hexadecimal notation.

C.1.1 Card Information Byte

This byte tells the controller which gauge channel to act on for reading pressure or changing status.

The card information byte consists of two nibbles. The first nibble is the board base address and is determined by the slot in which the board is installed. The second nibble is a 0 for HFIG and IMG boards and the Convectorr Gauge number (1,2,3...) for a Convection board. Since the XGS-600 board installation rules are different than Multigauge, the base address is not the same as the slot number. This allows maximum backwards compatibility with old applications. The mapping of slots and addresses is shown in Table C-1 (in the following instructions slot # refers to the XGS-600 physical slot):

Table C-1 Card Information Byte Mapping

XGS-600 Slot #	BCD base Address
1	2
2	3
3	4
4	5

XGS-600 Gauge Controller

Table C-1 Card Information Byte Mapping (Continued)

XGS-600 Slot #	BCD base Address
5	1
6	6

This means that if a Multigauge had a UHV card installed in MG slot # 3, the HFIG card would have to be installed in XGS600 slot #2 for its BCD address to also be 3.

C.1.2 Emulation of MG 4 Channel TC CARD

Since XGS-600 does not have a 4-channel TC card, backwards compatibility requires some way to emulate the 4-channel card. This is accomplished by installing two convection cards in physically adjacent slots. Doing this allows the second card to be addressed as the third and fourth channels of the first card and causes the Read Contents command to report the two cards as a 4-channel TC card installed in the lower numbered slot.

Example1: Convection cards are installed in slot #'s 5 and 6.

- Read Contents command reports *40h* for slot #5 (BCD addr 1).
- The card installed in slot 5 is addressed as BCD addrs 11 + 12. The card in slot 6 is addressed as BCD addrs 13 and 14.

Example 2: Convection cards are installed in slots 5 and 1.

- The Read Contents command reports the cards as *48H* at BCD addresses 1 and 2.
- The card installed in slot #5 is addressed as 11 + 12. The card in slot #1 is addressed as 21 and 22. This maintains compatibility with MG using two convector cards.

C.1.3 Pressure Information

Pressure information is transmitted in the format of *x.xxxExx* and requires three bytes. The first two are the mantissa and the third is the exponent in two's complement notation.

For example:

7.600 E+2 --- {76h} {00h} {02h}
2.145E-7 --- {21h} {45h} {F9h}
OFF ---- {00h} {00h} {00h}

Error codes are transmitted in MG/Sentorr format.

For example:

NO FIL1 is reported as E05 ---- {0Eh} {00h} {05h}

XGS-600 Gauge Controller

P>MAX is reported as E09 ---- {0Eh} {00h} {09h}

Parameter information consists of two bytes, where Sensitivity is xx.xx and emission current and gas correction are x.xxx.

For example:

Sensitivity = 20.00 --- {20h} {00h}

emission current = 3.500ma - {35h} {00h}

C.1.4 Reading All Pressure Channels

You can read all installed gauge channels with a single query command. The number of returned bytes is three times the number of installed gauges. The gauges are read in the order of the BCD base address. No separators are sent between bytes.

C.1.5 Read MultiGauge Contents Command

To maintain compatibility with Multigauge, which only had 5 slots, this command outputs the ID of cards that are installed in addresses 1-5 only, even if a card is installed in BCD address 6.

The Multigauge's Porting capability is not supported by the XGS600

C.2 Command List

Table C-2 lists all of the Multigauge BCD commands supported by the XGS600. The XGS600 does not support all old commands.

Table C-2 BCD Command List

Command	Byte # and Syntax	Byte # - Response
Read Card Contents (1 byte) Response (5 bytes)	Byte 1- {01h} where: 10h = HFIG card set for UHV24 or UHV24p 20h = HFIG card set to 564, MBA100, MBA200 30h = HFIG card set to 572,571,563 3Ah= IMG card 40h = emulated 4ch TC card 48h = Convection card FFh = empty slot	Byte 1 - {card #1-ID} Byte 2 - {card #1-ID} Byte 3 - {card #1-ID} Byte 4 - {card #1-ID} Byte 5 - {card #1-ID}
Read Pressure (2 bytes) Response (3 bytes)	Byte 1- {02h} Byte 2- {card info byte} while ---- appears, the response is 3 bytes of {00h}	Byte 1 - {mantissa digits 1,2} Byte 2 - {mantissa digits 3,4} Byte 3 - {exponent}
Read SW Revision (1 byte) Response (2 bytes)	Byte 1- {05h} where the revision is Px.y	Byte 1 - {0xh} Byte 2- {0yh}
Reset to Default (1 byte)	Byte 1- {06h}	
Read Pressure Units (1byte) Response (1 byte)	Byte 1- {13h} where: 00h = Torr 01h = mBar 02h = Pa	Byte 1 - {xxh}

XGS-600 Gauge Controller

Table C-2 BCD Command List (Continued)

Command	Byte # and Syntax	Byte # - Response
Emission OFF (2 byte)	Byte 1- {30h} Byte 2- {card info byte}	
Emission ON (2 bytes)	Byte 1- {31h} Byte 2- {card info byte}	
Emission ON Fil2 (2 bytes)	Byte 1- {33h} Byte 2- {card info byte}	
Read Emission Status (2 bytes) Response (1 byte)	Byte 1- {32h} Byte 2- {card info byte} where 00h = OFF 01h = ON 02h = ON Fil2	Byte 1 - {xxh}
Degas OFF (2 bytes)	Byte 1- {40h} Byte 2- {card info byte}	
Degas ON (2 bytes)	Byte 1- {41h} Byte 2- {card info byte}	
Read Degas Status (2 bytes) Response (1 byte)	Byte 1- {42h} Byte 2- {card info byte} where 00h = OFF 01h = ON	Byte 1 - {xxh}
Read Emission Curr (2 bytes) Response (2 bytes)	Byte 1- {52h} Byte 2- {card info byte}	Byte 1 - mantissa digits 1,2 Byte 2- {mantissa digits 3,4}
Set Emission Curr (4 bytes)	Byte 1- {53h} Byte 2- {card info byte} Byte 3- {mantissa digits 1,2} Byte 4- {mantissa digits 3,4}	

XGS-600 Gauge Controller

Table C-2 BCD Command List (Continued)

Command	Byte # and Syntax	Byte # - Response
Read Sensitivity (2 bytes) Response (2 bytes)	Byte 1 - {54h} Byte 2 - {card info byte}	Byte 1- {mantissa digits 1,2} Byte 2- {mantissa digits 3,4}
Set Sensitivity (4 bytes)	Byte 1- {55h} Byte 2- {card info byte} Byte 3- {mantissa digits 1,2} Byte 4 - {mantissa digits 3,4}	
Set TC/Conv to ATM (2 bytes)	Byte 1- {A1h} Byte 2 - {card info byte}	
Set TC/Conv to VAC (2 bytes)	Byte 1 - {A2h} Byte 2 - {card info byte}	
Read Pressure All (1 byte) Response (3 bytes times the number of gauges)	Byte 1 - {0Fh}	Byte 1- {mantissa digits 1,2} Byte 2- {mantissa digits 3,4} Byte 3- {exponent} ..{ } { } { } Runs from the lowest # address gauge to the highest# addr gauge

Appendix D. Gas Correction Factor Table

Table D-1 on page D-2 lists relative gauge gas correction factors for various gases. The table is reproduced for convenience only.

WARNING



The XGS-6000 used with any ion or convection gauge is NOT considered intrinsically safe, and should not be used with potentially flammable or explosive gas mixtures.

The values are derived by empirical methods substantiated by measurements reported in literature. This table was compiled and published by Robert L. Summers of Lewis Research Center, NASA Technical Note TND-5285, National Aeronautics and Space Administration, Washington, DC, June 1969.

To automatically convert readings of the XGS-600 Controller, normally calibrated for nitrogen, to read pressures of the other gasses:

1. Use *Sensor Setup* to access the *GAS CORRECTION* function.
2. Enter the correction constant from the table.

The XGS600 multiplies the initial pressure reading by the gas correction constant and displays the correct adjusted value. The default for Gas Correction is 1.

The correction for different gas species is purely arithmetic. The sensitivity of the tube is affected by different gases which, in turn, are responsible for the tube output being manipulated by the pressure equation. There is some loss in resolution of the instrument when gas correction constants are used. The loss in resolution becomes more apparent as the correction constants approach 0.5 from either direction.

When the correction constants are 0.1 or 10, the tube output is 1/10 or 10 times normal. This causes the instrument to lose the high vacuum decade or the near atmosphere decade, respectively.

XGS-600 Gauge Controller

Table D-1 Gas Correction Factor Table

Gas Type	Gas Correction Factor
Air/Nitrogen	1.00
Acetone	0.28
Argon	0.77
Carbon Dioxide	0.71
Carbon Monoxide	0.95
Chlorine	1.47
Deuterium	2.86
Ethanol	0.28
Ethylene	0.43
Helium	5.56
Hydrogen	2.17
Krypton	0.53
Methane	0.71
Methanol	0.56
Neon	0.30
Nitrous Oxide	0.67
Oxygen	1.00
Water	0.91
Xenon	0.34

Vacuum Products Division Instructions for returning products

Dear Customer:

Please follow these instructions whenever one of our products needs to be returned.

- 1) Complete the attached Request for Return form and send it to Agilent Technologies (see below), taking particular care to identify all products that have pumped or been exposed to any toxic or hazardous materials.
- 2) After evaluating the information, Agilent Technologies will provide you with a Return Authorization (RA) number via email or fax, as requested.
Note: Depending on the type of return, a Purchase Order may be required at the time the Request for Return is submitted. We will quote any necessary services (evaluation, repair, special cleaning, eg).
- 3) **Important steps for the shipment of returning product:**
 - Remove all accessories from the core product (e.g. inlet screens, vent valves).
 - Prior to shipment, drain any oils or other liquids, purge or flush all gasses, and wipe off any excess residue.
 - If ordering an Advance Exchange product, **please use the packaging from the Advance Exchange to return the defective product.**
 - Seal the product in a plastic bag, and package product carefully to avoid damage in transit. You are responsible for loss or damage in transit.
 - Agilent Technologies is not responsible for returning customer provided packaging or containers.
 - **Clearly label package with RA number.** Using the shipping label provided will ensure the proper address and RA number are on the package. Packages shipped to Agilent without a RA clearly written on the outside cannot be accepted and will be returned.
- 4) Return only products for which the RA was issued.
- 5) **Product being returned under a RA must be received within 15 business days.**
- 6) **Ship to the location specified on the printable label, which will be sent, along with the RA number, as soon as we have received all of the required information.** Customer is responsible for freight charges on returning product.
- 7) Return shipments must comply with all applicable **Shipping Regulations** (IATA, DOT, etc.) and carrier requirements.

RETURN THE COMPLETED **REQUEST FOR RETURN** FORM TO YOUR NEAREST LOCATION:

EUROPE:
Fax: 00 39 011 9979 330
Fax Free: 00 800 345 345 00
Toll Free: 00 800 234 234 00
vpt-customer@agilent.com

NORTH AMERICA:
Fax: 1 781 860 9252
Toll Free: 800 882 7426, Option 3
vpl-ra@agilent.com

PACIFIC RIM:
please visit our website for individual
office information
<http://www.agilent.com>



Please read important policy information on Page 3 that applies to all returns.

1) CUSTOMER INFORMATION

Company Name:		Contact Name:	
Tel:	Email:	Fax:	
Customer Ship To:		Customer Bill To:	
Europe only: VAT reg. Number:		USA/Canada only: <input type="checkbox"/> Taxable <input type="checkbox"/> Non-taxable	

2) PRODUCT IDENTIFICATION

Product Description	Agilent P/N	Agilent S/N	Original Purchasing Reference

3) TYPE OF RETURN (Choose one from each row and supply Purchase Order if requesting a billable service)

- 3A.** Non-Billable Billable **➔** New PO # (hard copy must be submitted with this form):
- 3B.** Exchange Repair Upgrade Consignment/Demo Calibration Evaluation Return for Credit

4) HEALTH and SAFETY CERTIFICATION

AGILENT TECHNOLOGIES CANNOT ACCEPT ANY PRODUCTS CONTAMINATED WITH BIOLOGICAL OR EXPLOSIVE HAZARDS, RADIOACTIVE MATERIAL, OR MERCURY AT ITS FACILITY.

Call Agilent Technologies to discuss alternatives if this requirement presents a problem.

The equipment listed above (check one):

- HAS NOT** pumped or been exposed to any toxic or hazardous materials. OR
- HAS** pumped or been exposed to the following toxic or hazardous materials. If this box is checked, the following information must also be filled out. Check boxes for all materials to which product(s) pumped or was exposed:

- Toxic Corrosive Reactive Flammable Explosive Biological Radioactive

List all toxic/hazardous materials. Include product name, chemical name, and chemical symbol or formula:

NOTE: If a product is received at Agilent which is contaminated with a toxic or hazardous material that was not disclosed, **the customer will be held responsible** for all costs incurred to ensure the safe handling of the product, and **is liable** for any harm or injury to Agilent employees as well as to any third party occurring as a result of exposure to toxic or hazardous materials present in the product.

Print Name: _____ **Authorized Signature:** **Date:** _____

5) FAILURE INFORMATION:

Failure Mode (REQUIRED FIELD. See next page for suggestions of failure terms):
Detailed Description of Malfunction: (Please provide the error message)
Application (system and model):

I understand and agree to the terms of Section 6, Page 3/3.

Print Name: _____ **Authorized Signature:** **Date:** _____



Vacuum Products Division
Request for Return Form
(Health and Safety Certification)

Please use these Failure Mode to describe the concern about the product on Page 2.

TURBO PUMPS and TURBO CONTROLLERS

Table with 3 columns: APPARENT DEFECT/MALFUNCTION, POSITION, and PARAMETERS. Lists various failure modes like 'Does not start', 'Noise', 'Vertical', 'Horizontal', etc.

ION PUMPS/CONTROLLERS

Table listing failure modes for Ion Pumps/Controllers: Bad feedthrough, Vacuum leak, Error code on display, Poor vacuum, High voltage problem, Other.

VALVES/COMPONENTS

Table listing failure modes for Valves/Components: Main seal leak, Solenoid failure, Damaged sealing area, Bellows leak, Damaged flange, Other.

LEAK DETECTORS

Table listing failure modes for Leak Detectors: Cannot calibrate, Vacuum system unstable, Failed to start, No zero/high background, Cannot reach test mode, Other.

INSTRUMENTS

Table listing failure modes for Instruments: Gauge tube not working, Communication failure, Error code on display, Display problem, Degas not working, Other.

SCROLL AND ROTARY VANE PUMPS

Table listing failure modes for Scroll and Rotary Vane Pumps: Pump doesn't start, Doesn't reach vacuum, Pump seized, Noisy pump (describe), Over temperature, Other.

DIFFUSION PUMPS

Table listing failure modes for Diffusion Pumps: Heater failure, Doesn't reach vacuum, Vacuum leak, Electrical problem, Cooling coil damage, Other.

Section 6) ADDITIONAL TERMS

Please read the terms and conditions below as they apply to all returns and are in addition to the Agilent Technologies Vacuum Product Division – Products and Services Terms of Sale.

- Customer is responsible for the freight charges for the returning product. Return shipments must comply with all applicable Shipping Regulations (IATA, DOT, etc.) and carrier requirements.
Customers receiving an Advance Exchange product agree to return the defective, rebuildable part to Agilent Technologies within 15 business days. Failure to do so, or returning a non-rebuildable part (crashed), will result in an invoice for the non-returned/non-rebuildable part.
Returns for credit toward the purchase of new or refurbished Products are subject to prior Agilent approval and may incur a restocking fee. Please reference the original purchase order number.
Units returned for evaluation will be evaluated, and a quote for repair will be issued. If you choose to have the unit repaired, the cost of the evaluation will be deducted from the final repair pricing. A Purchase Order for the final repair price should be issued within 3 weeks of quotation date. Units without a Purchase Order for repair will be returned to the customer, and the evaluation fee will be invoiced.
A Special Cleaning fee will apply to all exposed products per Section 4 of this document.
If requesting a calibration service, units must be functionally capable of being calibrated.

This page intentionally left blank.

Agilent Technologies

Vacuum Product Division

United States & Canada

Agilent Technologies
Vacuum Products Division
121 Hartwell Avenue
Lexington, MA 02421 USA
Tel: +1 781 861 7200
Toll-Free: +1 800 882 7426
Fax: +1 871 860 5437

Benelux

Agilent Technologies
Vacuum Products Division
Herculesweg 8
4338 PL Middelburg
THE NETHERLANDS
Tel: +31 118 671570
Fax: +31 118 671569

China

Agilent Technologies
Vacuum Products Division
Room 1648
Central Tower South Wing
Beijing Junefield Plaza
No. 10 XuanWuMenWai Street
Beijing 100052 P.R. CHINA
Tel.: +86 (10) 6310 8550
Toll-Free: 800 820 3278
Fax: +86 (10) 6310 0141

France

Agilent Technologies
Vacuum Products Division
7 avenue des Tropiques
Z.A. de Courtaboeuf - B.P. 12
91941 Les Ulis cedex FRANCE
Tel.: +33 (0) 1 69 86 38 84
Fax: +33 (0) 1 69 86 29 88

Germany & Austria

Agilent Technologies
Vacuum Products Division
Alsfelder Strasse 6
Postfach 11 14 35
64289 Darmstadt GERMANY
Tel.: +49 (0) 6151 703 353
Fax: +49 (0) 6151 703 302

India

Agilent Technologies
Vacuum Product Division
205-A, "A" wing of Galleria,
2nd floor, Hiranandani Gardens,
Powai, Mumbai-400 076, India
Tel.: +91 22-2570 8595 / 8597
Fax: +91 22- 2570 8599

Italy

Agilent Technologies
Vacuum Products Division
via F.lli Varian 54
10040 Leini, (Torino) ITALY
Tel.: +39 011 997 9111
Toll-Free: 00 800 234 234 00
Fax: +39 011 997 9350

Japan

Agilent Technologies
Vacuum Products Division
Sumitomo Shibaura Building 4-16-36
8th Floor
4-16-36 Shibaura Minato-ku
Tokyo 108 JAPAN
Tel.: +81 3 5232 1253
Toll-Free: 0120 655 040
Fax: +81 3 5232 1710

Korea

Agilent Technologies
Vacuum Products Division
Shinsa 2nd Bldg. 2F 966-5
Daechi-dong
Kangnam-gu, Seoul
KOREA 135-280
Tel.: +82 2 3452 2452
Toll-Free: 080 222 2452
Fax: +82 2 3452 2451

Mexico

Agilent Technologies
Vacuum Products Division
Concepcion Beistegui No 109
Col Del Valle C.P. 03100
MEXICO, D.F.
Tel.: +52 5 523 9465
Fax: +52 5 523 9472

Southeast Asia

Agilent Technologies
Vacuum Products Division
South East Asia (SEA) - Alex Ho
H/P: +601 2213 1253
Fax: +603 6733 8121

Singapore

Agilent Technologies
Vacuum Products Division
Singapore
Unit 10-04 Helios
Biopolis @ one-north
11 Biopolis Way, 138667
Singapore
H/P: +65 92364988
Fax: +65 64789603

Taiwan

Agilent Technologies
Vacuum Products Division
14F-6, No. 77, Hsin Tai Wu Road,
Sec. 1
Hsi chih, Taipei Hsien, Taiwan,
R.O.C.
Tel.: +886 2 2698 9555
Toll Free: 0800 051 342
Fax: +886 2 2698 9678

UK & Ireland

Agilent Technologies
Vacuum Products Division
6 Mead Road
Oxford Industrial Park
Tel.: +44 (0) 1865 291570
Fax: +44 (0) 1865 291571



Agilent Technologies