



ASM 310

Portable leak detector

Operating instructions

Dear customer,

You have just bought an adixen detector.

We would like to thank you and we are proud to count you among our customers.

This product is a result of the experience acquired since many years in vacuum and leak detection technology.

The applications of helium leak testing are extremely diversified ranging from high-tech installation maintenance to high-speed testing of industrial products.

Each product of the adixen detector range is designed to meet the specific needs of each application:

- portability,
- high sensitivity,
- pumping capacity,
- pumping type.



This product complies with the requirements of European Directives, listed in the Declaration of Conformity contained in G100 of this manual. These Directives are amended by Directive 93/68/E.E.C (E.C. Marking).

Copyright/Intellectual property:

***The use of adixen products are subject to copyright and intellectual property rights in force in any jurisdiction.
All rights reserved, including copying this document in whole or any part without prior written authorization from adixen Vacuum Products.***

Specifications and information are subject to change without notice by from adixen Vacuum Products.

Preliminary remarks

Throughout this operating manual, you could find this type of message **""Setting" menus arborescence  C 600"**: it refers to a specific chapter of the operating manual. Please read it for further information.

Chapter A

INTRODUCTION

- A 100 - Introduction
- A 200 - About leak detection
- A 400 - Accessories
- A 500 - Technical characteristics
- A 600 - Dimensions

Chapter B

INSTALLATION

- B 100 - Safety instructions
- B 110 - Unpacking - Storage - Transport
- B 112 - Product labelling
- B 200 - Neutral gas purge and inlet vent connection
- B 300 - Controlling the detector)
- B 301 - RS 232
- B 302 - 15 pin Interface
- B 400 - Start-up

Chapter C

OPERATION

- C 100 - Getting started with the leak detector
- C 110 - Perform a test
- C 200 - Control panel
- C 300 - Graphic display
- C 400 - Settings
- C 401 - Set points Menu
- C 402 - Test Menu
- C 403 - Spectro Menu
- C 404 - Maintenance Menu
- C 405 - Configuration Menu
- C 406 - Advanced Menu
- C 500 - Factory configuration of the leak detector parameters
- C 600 - "Setting" menus arborescence
- C 700 - Remote control (accessory)
- C 900 - Long distance sniffer probe and Helium spray gun (accessories)

Chapter D

MAINTENANCE - TROUBLESHOOTING

- D 100 - Indicator lights and default display
- D 200 - General troubleshooting guide
- D 200/D 300 - General troubleshooting guide/Symptoms description
- D 300 - Symptoms description

L0232 ≥ v3.3 r00
L0322 ≥ v3.3 r00
L0264 ≥ v3.2 r00
L0224 ≥ v2.0 r00

General contents

ASM 310 - Operating instructions

Chapter E

MAINTENANCE SHEETS

- E 100 - Maintenance operation instructions
- E 110 - Access to internal components
- E 120 - Table of preventive maintenance intervals
- E 141 - Leak detector tightness checking
- E 142 - Leak detector depollution
- E 231 - P0411 Supervisor board
- E 262 - P0482 Bluetooth board
- E 410 - Autocalibration of the leak detector
- E 411 - Calibration of a leak detector connected to a pumping group
- E 412 - Calibrated leaks
- E 413 - Replacement of the internal calibrated leak
- E 430 - Analyzer cell maintenance
- E 530 - Valves installation and maintenance
- E 550 - Replacement of a fan
- E 555 - Replacement of the purge filter
- E 600 - Remote control
- E 610 - Long distance sniffer probe and Helium spray gun (accessories)
- E 710 - Roughing pump maintenance (MD1)

Chapter F

COMPONENTS

- F 000 - Spares parts - Instructions of use
- F 001 - Service
- F 100 - Tools
- F 200 - Monitoring and display
- F 300 - Power and electrical supply
- F 400 - Automatic control system and electronic circuits
- F 500 - Measurement
- F 600 - Pumping
- F 700 - Valves
- F 800 - Pipes - Connections - Seals
- F 900 - Cover
- F 1000 - Options and accessories
- F 1100 - Pictures of components

Chapter G

APPENDIX

- G 100 - Declaration of conformity
- G 200 - Wiring diagram
- G 400 - Long distance sniffer probe user manual
- G 500 - Helium spray gun user manual
- G 600 - Service
- G 700 - Units
- G 800 - Tools



Introduction

ASM 310 Operating instructions Detailed contents

Preliminary remarks

Throughout this operating manual, you could find this type of message **""Setting" menus arborescence**  **C 600**: it refers to a specific chapter of the operating manual. Please read it for further information.

A 100

Introduction

A 200

About leak detection

- Overview
- Vacuum circuit of a leak detector
- Test method
- Analyzer cell operating principle
- About helium and hydrogen

A 400

Accessories

- Accessories Common to all leak detectors
- Specific accessories to one or several leak detectors

A 500

Technical characteristics

A 600

Dimensions

Introduction



Congratulations, you have just acquired a unique dry helium leak detector truly portable: the **ASM 310**.

The ASM 310 is the lightest unit of its category (**less than 48 lbs**) that offers the following features:

- 1 cfm (1.7 m³/h) dry and clean roughing capacity,
- 1.1 l/s helium pumping speed at the inlet of the unit,
- New analyzer cell design that delivers 3 years of full operation without any maintenance required,
- Operator interface display 100 % customized to meet all customers needs,
- Data acquisition downloadable to a SD memory card for easy storage and convenience (graphs as well as text),
- Import capabilities such as pictures (bmp format).

Ideally suited for any leak testing applications where portability is a Must, this unit will deliver more than you would expect. This is more than a helium leak detector, it is now yours to discover and enjoy.

About leak detection

Overview Leak detection is used to detect micro-openings, porosities, permeation through materials etc. The means of detection is a tracer gas: Helium. This gas is so light that it can penetrate microscopic cracks very fast.

The analyzer cell measures helium partial pressure created by helium molecules that come from the leaking parts. These molecules are pumped in by the vacuum pumps of the helium leak detector and end up inside the analyzer cell. This partial helium pressure is converted into a flow rate. The analyzer cell is tuned to detect three gas species, hydrogen (M2), helium isotope (M3) and helium (M4). For more information on the operating principle, please go to the end of this chapter.

The ASM 310 helium leak detector has a wide measuring range capability. It can detect a leak as large as 10^{-2} mbar l/s down to a leak as small as 3×10^{-11} mbar l/s.

A leak of 10^{-2} mbar l/s is equivalent to a bubble of 1 cc escaping a part every 100 seconds.

A leak of 3×10^{-11} mbar l/s corresponds to a bubble of 1 cc escaping a part every 1,050 years.

As for reference, please see below for more leak rate correlations.

For the same size crack, a part will leak out helium at different rates based on the internal helium pressure. The greater the internal helium pressure, the higher the leak rate.

Leak testing large leaks versus leak testing tiny leaks will require different settings, for more information, please go to chapter C.

Leak Rate	3×10^{-11} mbar l/s	1×10^{-10} mbar l/s	1×10^{-09} mbar l/s	1×10^{-08} mbar l/s	1×10^{-07} mbar l/s	1×10^{-06} mbar l/s	1×10^{-5} mbar l/s	1×10^{-04} mbar l/s	1×10^{-03} mbar l/s
1 cc Bubble over time frame	1,050 years	317 years	31.7 years	3.17 years	116 days	11.6 days	1.2 day	2.7 hours	17 minutes

About leak detection

Vacuum circuit of a leak detector

The general vacuum diagram of the leak detector is shown below. A dynamic version of the vacuum diagram is available on the leak detector display panel. Green valves indicate opened valves. Red valves indicate closed valves.

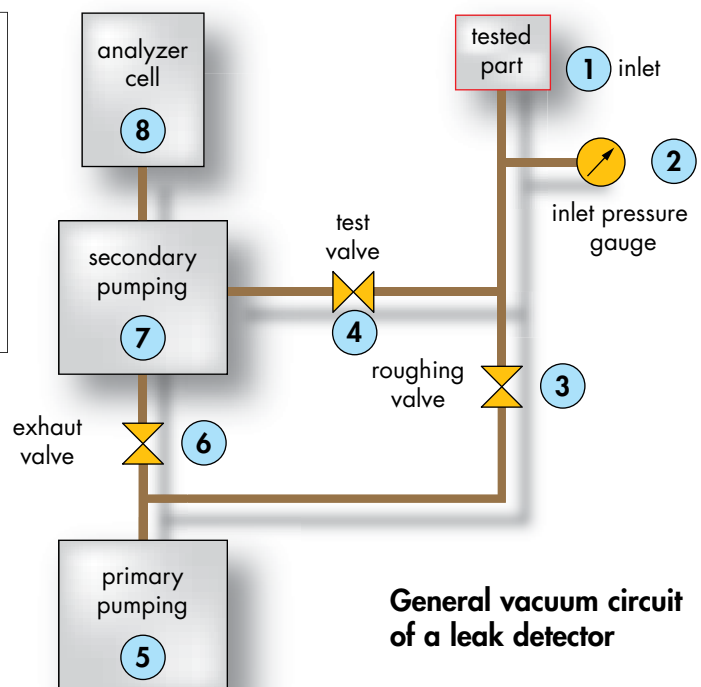
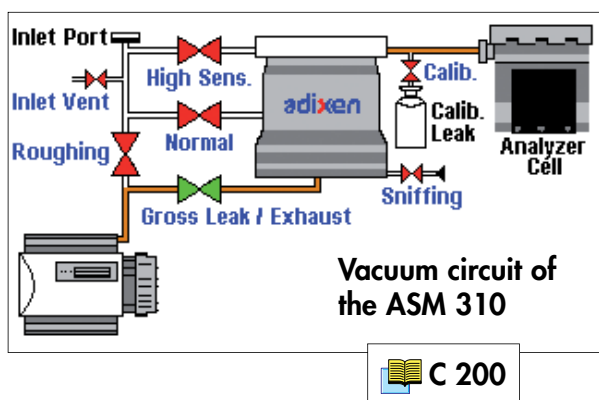

Test Procedure:

- Connect the part to be tested at the inlet of the leak detector (1), then press the [START/Stand by] key. When the unit is not in test mode (stand-by or roughing mode), the helium displayed corresponds to the internal helium background of the unit.
- Roughing Mode: Valve (3) opens and the primary pump evacuates the inlet of the unit as well as the part connected to it.
- When the inlet pressure (2) reaches the test cross over, the roughing valve (3) closes, the exhaust valve (6) opens, the test valve (4) opens. The high vacuum is then connected to the inlet of the leak detector taking care of the gas load. The analyzer cell (8) will measure any helium present. The value of the leak will be measured and displayed on the control panel.

About leak detection

Test method Choice

Several test methods are possible. The testing method is selected according to the test part and the measurement range required:

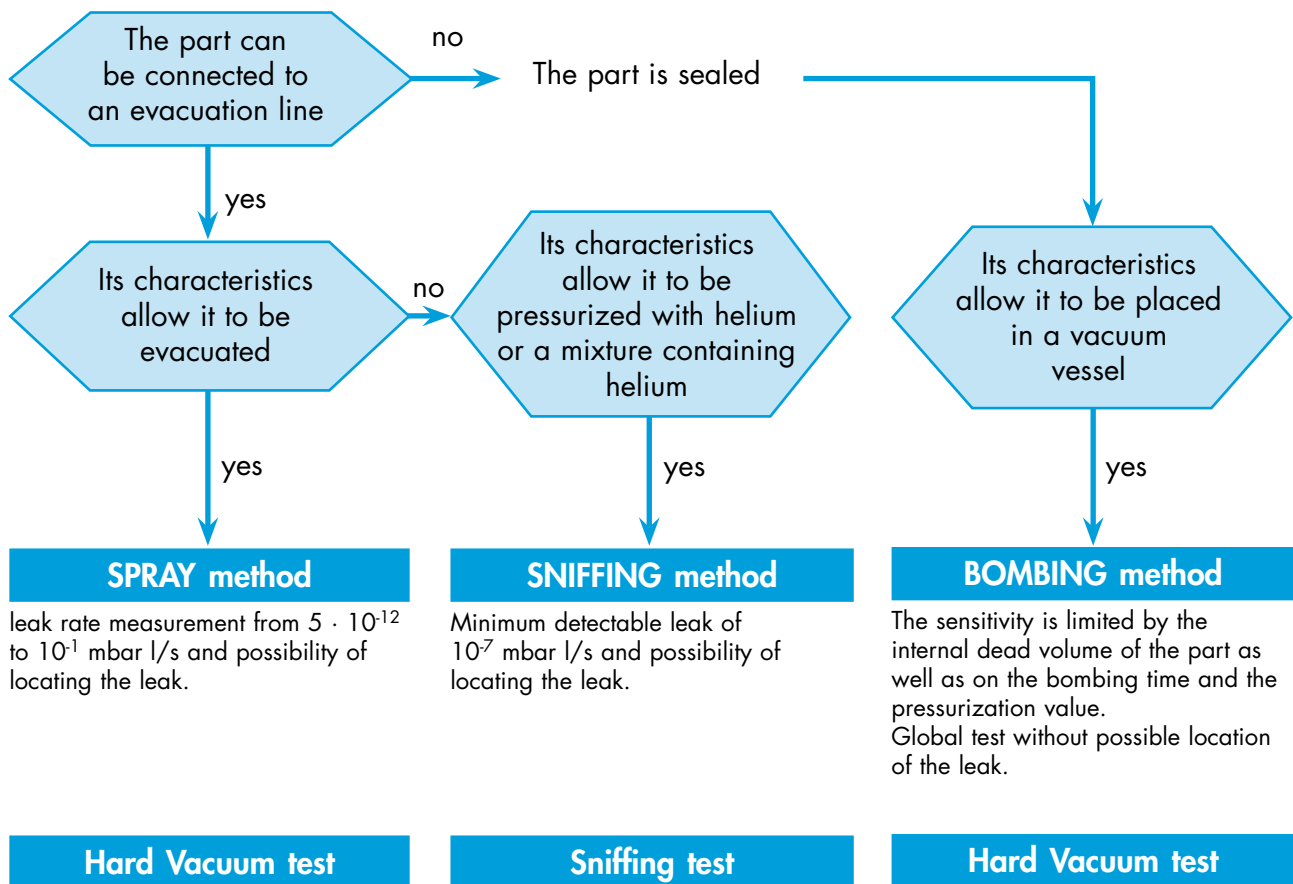

About leak detection

Spray method This involves removing air from the part tested, connecting it to the analyzer cell and then spraying helium over the outer surface.

Global test

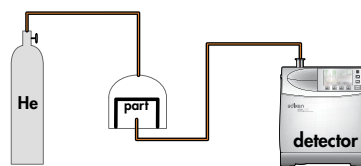

The part is placed under a cover, into which helium is injected.

The leak cannot be located.

The detector measures the flow of helium penetrating the part.

Connection rules: refer to  **B 300**

Spray test

or

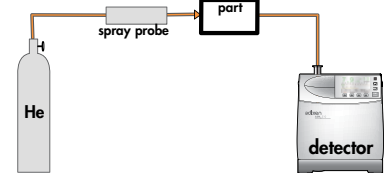

Potential leaking areas are sprayed with helium.

The leak can be located.

Response time

When spraying starts, the leak signal is not displayed instantaneously on the analyzer cell:

there is a response time which depends on the volume V being tested and the helium pumping speed S of the system at the opening of the part, according to the following relation:

$$T = V/S \quad (T \text{ in second, } V \text{ in litre, } S \text{ in l/s})$$

T is the time required for the signal to reach 63 % of the final value.

About leak detection

Sniffing method

The test part is pressurized with helium. The detector, via a sniffer probe samples the helium escaping from the part. Global test is generally kept for gross leaks ($> 10^{-3}$ mbar l/s). In 90 % of uses, the sniffing method is used in local.

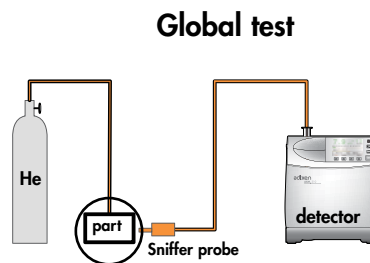

The part is placed under a cover containing a sniffer probe.

The leak cannot be located.

The helium from the leak accumulates over time inside the cover. The detector measures the concentration of helium.

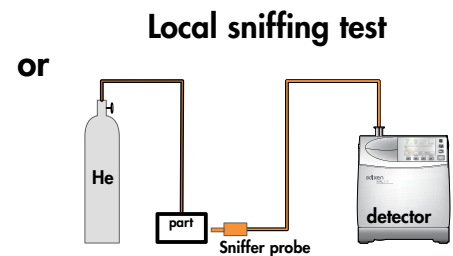

The sniffer probe is moved over areas likely to contain leaks.

The leak can be located.

The signal supplied by the analyzer is not an exact measurement of the leak. The sniffer probe only samples part of the helium escaping from the part. The sample depends on the distance separating the leak from the tip of the probe.

About leak detection

Bombing method

This method is used for sealed objects that cannot be connected directly to the detector (semiconductors, waterproof watches, etc.). The "MIL-STD-883- Method 1014" standard allows to comprehend parameters of this test. Before this test, it is necessary to do a gross leak test to remove parts with a very gross leak.

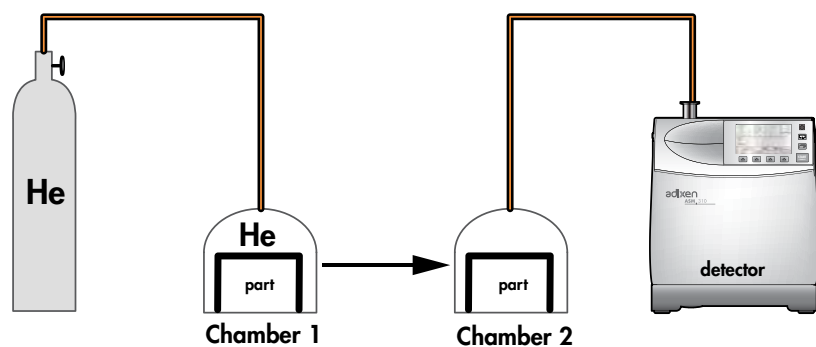

The part is placed in a chamber containing pressurized helium.

The helium penetrates the part if it has a leak.

The part is then removed from the chamber and placed in another vacuum chamber which is connected to the detector. The helium escapes from the part through the leak and produces a signal.

This signal is not a direct measurement of the leak as the helium pressure inside the part is difficult to determine. Several parts play an important part such as: the pressurization time, the helium bombing pressure, the internal volume, the aeration time, the size of the leak.

Please consult us for details about this method.

About leak detection

Analyzer cell operating principle

Description

The analyzer cell works on the principle of mass spectrometry and is set by default to the mass of helium ($m/e = 4$). Other gasses can be used (helium 3 or hydrogene).

m/e = atomic mass of the particle/number of electrons lost on ionization.

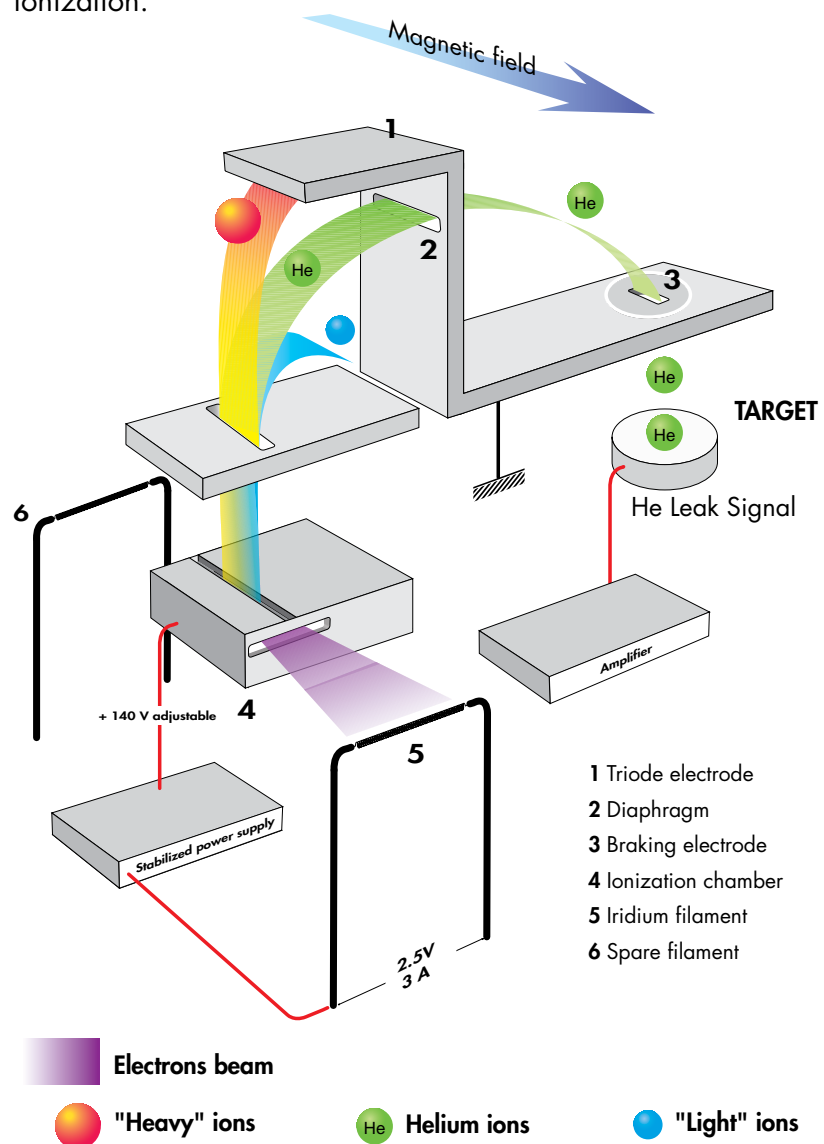

The principle of magnetic deflexion spectrometry is as follows.

The molecules of the gas being analyzed pass into an ionization chamber 4 where they are bombarded by an electron beam generated by a heated iridium filament 5. A large number of the molecules are transformed into ions.

About leak detection

The iridium filament allows a good performance at high pressures and a small overheating.

These ionized particles are accelerated by an electrical field.

They arrive in a zone subjected to a magnetic field which has the property of deflecting the trajectories of the ions along different curves according to the masses of those ions (to be more precised, according to their m/e ratios). Thus the ions beam, which contained ions with different masses, is divided into several beams, each containing only ions with the same m/e ratio. For example, the helium ions ($m/e = 4$) are separated from the lighter (H^{2+} or H^{1+} , smaller beams) or heavier ions (N^{2+} or O^{2+} , bigger beam).

The triode electrode **1** collects the ions which the mass is higher than the tracer gas mass. The electronic current measured in this way allows to calculate the total pressure in the analyzer cell.

Because there is a constant magnetic field (permanent magnet), the accelerator electrical field is adjusted so that the tracer gas ions follow a pre-determined trajectory (passing through diaphragm **2**) and arrive on the target at the input to a direct current amplifier.

In order to separate the helium ions from "noise" caused by other ions, an electrode located in front of the target eliminates them. This electrode **3** is called the "braking electrode".

The current of ions of the tracer gas is proportional to the partial pressure this one in the installation and by measuring it we can find the flow rate of the leak that has been detected.

It is essential that the total pressure in the analyzer cell is less than 10^{-3} mbar, so that the trajectories of the electrons and the ions are not disturbed by residual molecules.

There is a spare iridium filament **6** in the analyzer cell.

About leak detection

- Design** Great care has been taken with the design of the 3rd generation cell in order to repeatedly obtain the same characteristics and to achieve excellent stability:
- the metal parts are made of stainless steel,
 - the filament holder is made of machined aluminium and filament iridium,
 - there is an integrated amplifier.

The cell assembly is composed of:

■ **The vacuum chamber:**

The analyzer cell vacuum chamber is made of light alloy (aluminium).

■ **The main cover function is to contain and position the following 3 modules:**

- ionisation module: "ions" generation,
- braking module: ions sorting and dispersed ions suppression,
- equipped plate module: repected ions amplification.

■ **The preamplifier and its associated electronics:**

- Power supply board: delivers power to all the components
- Measure board: Treat and convert the signal into a digital signal (semi-log form).
- Preamp board: preamplification and mechanical interface.

About leak detection

About helium and hydrogen Helium

Helium is the second most common element in the universe, representing about 23 % of the total matter. 76 % is Hydrogen. All other elements represent an insignificantly small fraction of the total.

Helium is a 100 % green gas and has absolutely no environmental impact on the atmosphere.

Helium was discovered by spectroscopy in a solar eclipse on August 18, 1868. The discovery in the sun's chromosphere gave the new element its name: "helios" in Greek means "sun". While Helium is very common in the universe most of it is in the stars: on earth it is actually not abundant. Since it is so light all the Helium present during the formation of earth escaped to space.

Helium is created deep in the earth from the radioactive decay of uranium and thorium which also gives the earth its internal heat. On earth Helium was discovered in 1881 by spectroscopy of Mount Vesuvio in Italy – the volcanic gases emanated by the mountain showed the same lines in the spectrum as already known from the sun.

Helium concentration in the atmosphere is 5 times bigger than the one of Krypton and 60 times higher than Xenon. The heavier noble gases are isolated from air rectification. In contrary, Helium is "mined" from natural gas and oil wells and stored. The annual world wide production is ca. 3×10^7 m³ or 4,500 tons.

Helium is constantly seeping up from the ground all around us, but it is so light that almost all of it escapes into space fairly rapidly. On the other hand there is a constant flow of Helium from space and the sun to earth. This gives a dynamic equilibrium and is the reason for the world wide constant concentration of 5 ppm Helium in air.

Helium is a very light colorless element and it is one of the six noble gases which means it doesn't react with anything for all practical intents and purposes. It's the most difficult gas to liquefy.

It's used as an inert shield gas to protect things from oxidation – and of course as leak detection tracer gas.

About leak detection

Helium and leak detection: which purity?

Helium is commercialized in many different purity levels, the highest level of purity is requested from some laboratories for fundamental researches or very accurate analyses.

The use of the Helium as a tracer gas into a mass spectrometer doesn't require such attention. A purity in the range of 97 % to 99 % is enough.

There is absolutely no risk of accuracy lost or contamination for the analyzer cell by using standard purity level of Helium gas.

Hydrogenated nitrogen

If Hydrogen (H_2) and Oxygen (O_2) are mixed and heated, they react and create water vapor (H_2O). During this process more heat is generated which may (if the concentration is high enough) ignite the surrounding gas. If this process propagates, the gas explodes.

At low concentration of Hydrogen (< 4 % in air) the generated heat is not enough to ignite the surrounding gas.

At concentrations in the range 4 to 12 % the combustion may spread only if actions are taken to prevent the generated heat from dissipating. It is a common misconception that hydrogen will explode as soon as the concentration exceeds 4 %. It may explode only if conditions are favorable for spontaneous propagation of combustion.

⚠ DANGER

Never use pure hydrogen or a mixture with a hydrogen concentration higher than 10 % to realize a "hydrogen" test as tracer gas.

If you use the recommended tracer gas of 5 % H_2 / 95 % N_2 and mix it with air there will either be too little hydrogen or too little oxygen to constitute a combustible gas mixture. Hence this gas mixture is classified as non flammable. The actual limit is 5.7 %.

The mixture 10 % H_2 / 90 % N_2 is commonly used in the industry because it is flammable only under certain conditions. This mixture is however classified according to ISO 10156 as Flammable Gas and should only be used after due safety considerations and approvals.

Accessories

Accessories Common to all leak detectors

Calibrated leaks	C1
Calibration accessory in sniffing	C2
Remote control	C3
Sniffer probe	C4
Liquid sniffer probe	C5
Helium spray gun	C6
Locking clamp	C7
Bombing chambers	C8
Inlet filters	C9

Specific accessories to one or several leak detectors

		ASM 310	ASM 380	ASI 30
Transport case	S1	•		
Transport cart	S2	•		
Bottle support	S3		•	
Bluetooth (*)	S4		•	•
37 pin Input/Output board (*)	S5		•	•
37 pin Input/Output board with Wi-Fi (*)			•	•
37 pin Input/Output board with Ethernet (*)				
Profibus board (*)	S6			•
Industrial control panel (*)	S7			•
Sniffing kit (*)	S8			•
2005 IS primary pump	S9			•
Interface extension kit	S10			•
Power supply cords	S11	•		•
Measurement gauge	S12			•

(*) also available in option

You can find via our Web Site free softwares designed to help you in your applications. Refer to  **G 800**.

Accessories

C1 He calibrated leaks



(from 10^{-9} mbar l/s to 10^{-4} mbar l/s)

- Supplied with certificate of calibration.
- $\pm 10\%$ accuracy.
- Possibility to deliver a standard value (included in a predetermined range, see table below) or a specific value according to the customer requirement.

Decade	Range code	Standard value provided	Reservoir
10^{-9} mbar l/s	9	between 1 and $3 \cdot 10^{-9}$ mbar l/s	Aluminium
10^{-8} mbar l/s	8	between 1 and $3 \cdot 10^{-8}$ mbar l/s	Aluminium
10^{-7} mbar l/s	7	between 1 and $3 \cdot 10^{-7}$ mbar l/s	Aluminium
	3	between 3 and $6 \cdot 10^{-7}$ mbar l/s	250 cc stainless steel
10^{-6} mbar l/s	6	between 1 and $3 \cdot 10^{-6}$ mbar l/s	250 cc stainless steel
	5	between 5 and $8 \cdot 10^{-6}$ mbar l/s	250 cc stainless steel
10^{-5} mbar l/s	4	between 1 and $3 \cdot 10^{-5}$ mbar l/s	1000 cc stainless steel
	2	between 5 and $8 \cdot 10^{-5}$ mbar l/s	1000 cc stainless steel
10^{-4} mbar l/s	1	between 1 and $3 \cdot 10^{-4}$ mbar l/s	1000 cc stainless steel

Accessories

F	4			
---	---	--	--	--

Isolation valve		
	without	with
code	0	V

Manual isolation valve. The isolation valve is mandatory for values greater than $8 \cdot 10^{-6}$ mbar l/s

Gaz	
	Helium
code	4

Decades									
	10^{-9}	10^{-8}	10^{-7}	10^{-6}	10^{-5}	10^{-4}			
code	9	8	7	3	6	5	4	2	1

Flange				
	DN 16	DN 25	DN 40	DN 50
code	0	1	2	3 ⁽¹⁾

(1) DN 50 not available for decades 10^{-5} and 10^{-4} mbar l/s

Specific value		
	yes	no
code	1	0

- Temperature coefficient 3 % per degree Celsius for any value $< 8 \cdot 10^{-6}$ mbar l/s (permeation type), 0.2 % per °C for greater value (capillary type).
- Loss 2 % per year for any value $< 8 \cdot 10^{-6}$ mbar l/s.
- When a specific value is requested, due to the technology used,
- The manufacturer can only guarantee an effective nominal value within ± 20 % of the requested nominal value.

Ex: requested value = $1.8 \cdot 10^{-6}$ mbar l/s

- guaranteed delivered value between 1.44 et $2.16 \cdot 10^{-6}$ mbar l/s

- code in DN25 with a valve **FV4611**, and indicates "requested value = $1.8 \cdot 10^{-6}$ mbar l/s".

C2 Calibration accessory in sniffing

Used to connect the calibrated leak and the sniffer probe for a calibration.

Model	Part No
DN 16	110715
DN 25	110716



Accessories

C3 Remote control

The remote control is equipped with magnets allowing the operator to place it on a magnetized surface. The operator can read the helium signal and has access to control keys such as cycle command autocalibration and auto-zero.



English serigraphy

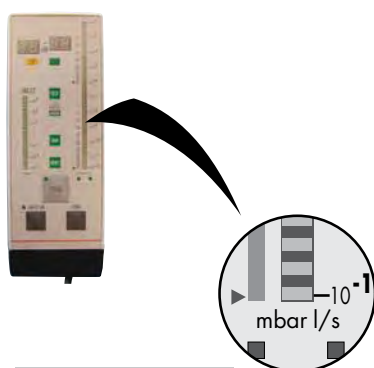

mbar l/s
or Torr l/s
or Pa m³/s

Japanese serigraphy

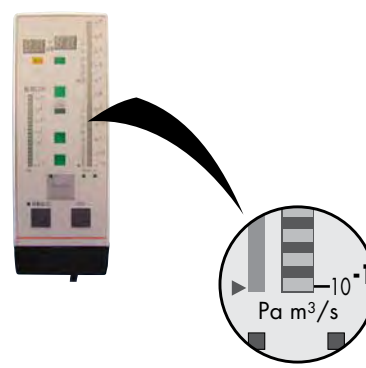

Pa m³/s
only

Remote control with 5 m/16.4 feet cable length:

Model	Part No
Unit: mbar l/s - Front face in English	106688
Unit: Torr l/s - Front face in English	108881
Unit: Pa m ³ /s - Front face in English	108880
Unit: Pa m ³ /s - Front face in English	106690

Cable for remote control (remote control not provided):



Cable only

Model	Part No
Cable of 10 m/32.8 feet/394 inches	101881
Cable of 15 m/49.2 feet/590 inches	101882
Cable of 20 m/65.5 feet/787 inches	802494
Cable of 25 m/82 feet/984 inches	802339
Cable of 30 m/98.4 feet/1181 inches	802767
Cable of 35 m/114.8 feet/1378 inches	802768
Cable of 40 m/131.2 feet/1575 inches	802769
Cable of 45 m/147.6 feet/1772 inches	802770
Cable of 50 m/164 feet/1968 inches	802771

Accessories

C4 Sniffer probe Sniffer probe with rigid nozzle Sniffer probe with flexible nozzle



Sniffer probe part number	5 m tubing				10 m tubing			
	Rigid nozzle		Flexible nozzle*		Rigid nozzle		Flexible nozzle*	
	9 cm	30 cm	15 cm	45 cm	9 cm	30 cm	15 cm	45 cm
	SNC1E1T1	SNC1E2T1	SNC1E3T1	SNC1E4T1	SNC2E1T1	SNC2E2T1	SNC2E3T1	SNC2E4T1

* Sniffer probes with flexible nozzle cannot be used with the ASM 310.

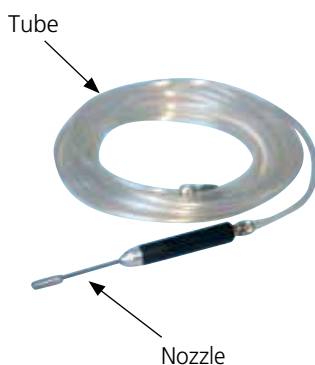

Sniffer probe with short rigid nozzle (9 cm/3.5"):

Model	Part No
Tube length 20 m/69.6 feet/787 inches	802826
Tube length 30 m/96.4 feet/1181 inches	802827
Tube length 40 m/131.2 feet/1575 inches	802828
Tube length 50 m/164 feet/1968 inches	802829
Tube length 60 m/169.8 feet/2362 inches	802830
Tube length 70 m/229.6 feet/2756 inches	802831
Tube length 80 m/232.4 feet/3150 inches	802832
Tube length 90 m/295.2 feet/3543 inches	802833
Tube length 100 m/328 feet/3937 inches	802834

Sniffer probe with long flexible nozzle (30 cm/18"):

Model	Part No
Tube length 20 m/69.6 feet/787 inches	802835
Tube length 30 m/96.4 feet/1181 inches	802836
Tube length 40 m/131.2 feet/1575 inches	802837
Tube length 50 m/164 feet/1968 inches	802838
Tube length 60 m/169.8 feet/2362 inches	802839
Tube length 70 m/229.6 feet/2756 inches	802840
Tube length 80 m/232.4 feet/3150 inches	802841
Tube length 90 m/295.2 feet/3543 inches	802842
Tube length 100 m/328 feet/3937 inches	802843

Accessories

C5 Liquid sniffer probe (to be connected to the inlet port of a leak detector)

Temperature coefficient: 7 % per °Celcius.

Standard leak rate: $2 \cdot 10^{-4}$ mbar l/s

Able to measure helium concentration inside water or liquids.



Model	Flange	Part No
Sniffer probe with membrane	DN 25	103592
Sniffer probe with membrane and smooth tube connection	Ø 14 mm	067678

Accessories

C6 Helium spray gun Part number: 109951

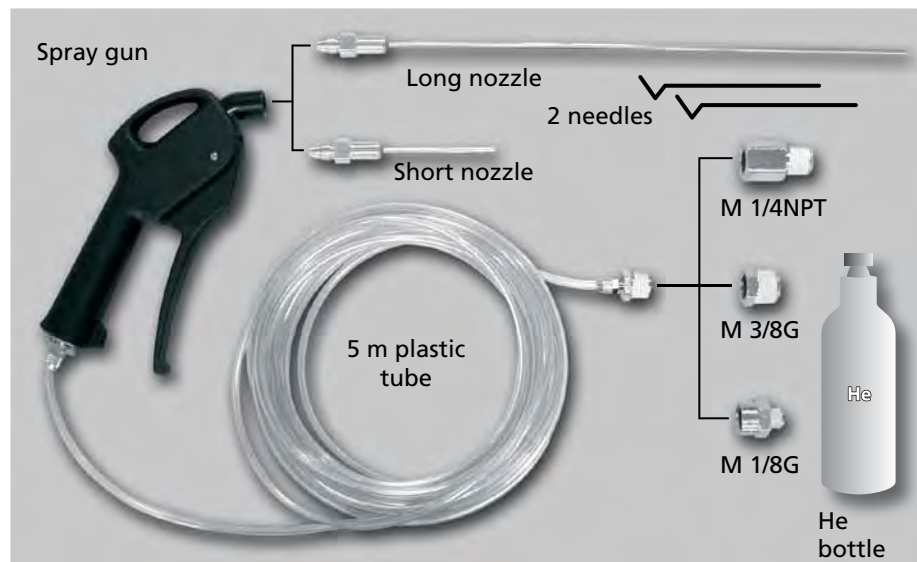

Spraying Helium in order to detect a leak is usually very easy, especially if you need fast and rough detection.

Spraying Helium could also become a technical challenge when you need to pinpoint very fine leaks, especially when they are located in areas with difficult access.

The Helium spray gun is an easy to use and multipurpose tool which allows you to work in various conditions of test:

- Multi standard: thanks to the 3 different adapters to be connected to the Helium bottle (M 1/4 NPT, M 3/8G and M 1/8G).
- Multi purpose: thanks to the 2 nozzle lengths of 80 mm / 3.14 inch and 290 mm / 14.4 inch.
- Standard leak mode: for quick and rough leak tests.
- Fine leak mode.

The Helium spray gun is provided with 2 standard needles which allow the adjustment of the Helium flow at the outlet of the nozzle.

Accessories

C7 Locking clamp DN 40 KF

Part number: **118801**

Like classical clamp, the locking clamp allows to fix an accessory: however, you must use a special tool delivered with to open/close the clamp.



Fixing ring detail



Special tool use

C8 Bombing chambers

Model	DN Flange	Part No
Bombing chamber 10 bars (Ø 150 - L 200 - Vol.: 3.5 l)	-	786396
Bombing chamber 25 bars (Ø 150 - L 200 - Vol.: 6.4 l)	-	786397



C9 Inlet filters Complete inlet filters



Model	DN Flange	Part No
20 µm inlet filter	25/25	105841
20 µm inlet filter	40/40	105842
20 µm inlet filter	40/25	105843
5 µm inlet filter	25/25	105844
5 µm inlet filter	40/40	105845
5 µm inlet filter	40/25	105846

Accessories

Spare parts for inlet filters

	Model	DN Flange	Part No
	stainless steel mesh filter 70 µm	16	072721
	stainless steel mesh filter 70 µm	25	072857
	stainless steel mesh filter 70 µm	40	067636
	20 µm inlet filter	Ø 114 mm	105847
	5 µm inlet filter	Ø 114 mm	105848
	O'ring, dia. 5 mm	Ø 114 mm	082152

Accessories

S1 Transport case Part number: 119594



S2 Transport cart Part number: 114820



CAUTION

Maxi authorized weight on the transport cart: 26 kg/57 lb
Compulsory fixing to the leak detector.

Accessories

S3 Bottle holder

Part number: **118444**

The bottle holder allows to fix a helium bottle of Ø 180 mm maximum on the leak detector (example: B5 or B11 type).



The helium bottle is not supplied with bottle holder: it is at the customer's charge.



Bottle holder fixed on the leak detector



Bottle holder equipped with helium bottle

Installation: Refer to  **B 240**.

S4 Bluetooth

Part number: **P0482E1**

Description  **A 300**.

Installation and use: refer to  **B 308**.



Accessories

S5 Input/Output board

37 pin input/output board

	ASM 380	ASI 30
Part number	118088S	118577

Description  A 300.

Installation and use: refer to  B 308.

Check compatibility between « 37 pin input/output board » accessory and the other interfaces in option/accessory: refer to  B 300.

37 pin input/output board with Wi-Fi

	ASM 380	ASI 30
Part number	118089S	118578

Description  A 300.

Installation and use: refer to  B 305.



Check compatibility between « 37 pin input/output board with Wi-Fi » accessory and the other interfaces in option/accessory: refer to  B 300.

37 pin input/output board with Ethernet

	ASM 380	ASI 30
Part number	118090S	118579

Description  A 300.

Installation and use: refer to  B 306.





Check compatibility between « 37 pin input/output board with Ethernet » accessory and the other interfaces in option/accessory: refer to  B 300.

Accessories

S6 Profibus board Part number: 118581

Description  A 300.

Installation and use: refer to  B 307.

Check compatibility between « Profibus board » accessory and the other interfaces in option/accessory: refer to  B 300.

S7 Industrial control panel

Industrial control panel with ½ 19» rack format is available with 3 different lengths cables linking the electronic module and the control panel: 1.8 m, 5 m or 10 m.

Model	Part No
½ rack industrial control panel (only)	119100S
Cable of 1.8 m length	114435
Cable of 5 m length	A458735
Cable of 10 m length	110881

S8 Sniffing kit Part number: 104757

It is composed of:

- a sniffing cell,
- 2 quick connectors (male and female),
- connection accessories,
- pipe.



This option allows working in sniffing mode.

Kit installation:  B 240.

The option use requires a primary pumping associated to the leak detector: at the customer's charge.

Sniffing probe required in sniffing mode is not delivered in the kit: at the customer's charge.

Accessories

S9 2005 SI Pump This accessory allows adding a primary pumping to the leak detector. This primary pumping connected to the "Sniffing kit" option/ accessory, will allow working sniffing mode.

Characteristics

- 2 stages pump
- flow rate: 4 m³/h
- connector for LDS
- voltages should be specified when ordering
- supplied without connecting accessories.
- accessories for primary pump:
 - filter OME 25 S – P/N **104200**
 - filter cartridge – P/N **068304**

Part No to command

205 SIX X X M

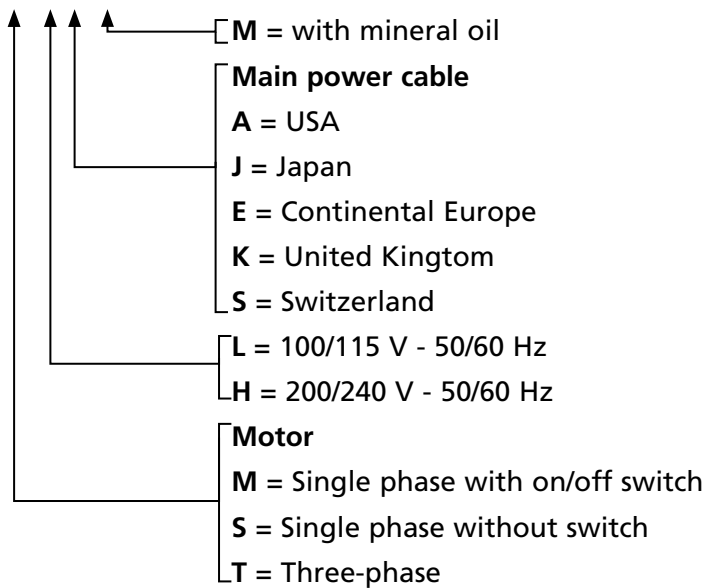

Accessories

S10 Interface extension kit

Part number: **119428**

The « Interface extension kit » allows having 3 screw plug connectors on the ASI 30 instead of a 37 pins Sub D connector.

It is composed of:

- an interface extension board,
- a kit with screws and fixing braces
- 3 female connectors.

Kit installation:  **B 240.**

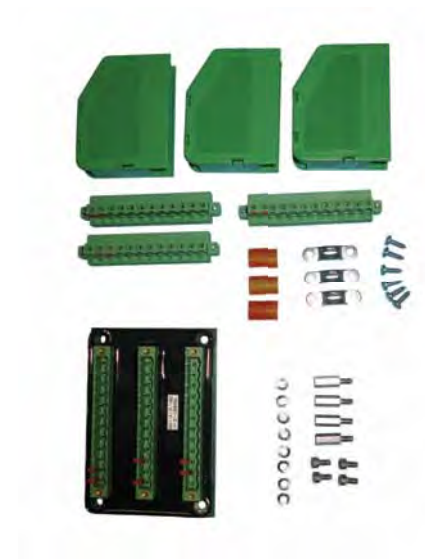

S11 Power supply cords

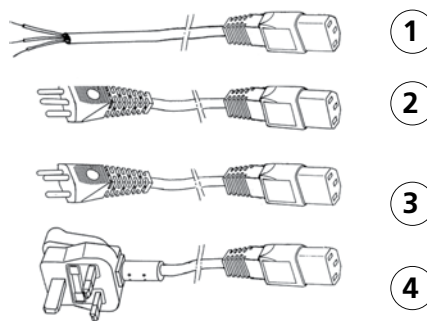

	Designation	Part No
①	Cable, main power; 2 m - without plug	104559
②	Cable, main power; 2 m - Italy	104758
③	Cable, main power; 2 m - Switzerland	103718
④	Cable, main power; 2.5 m - United Kingdom	104411

Accessories

S12 Measurement gauge

Gauge part number: PT R26 950

Gauge cable part number: PT 448 250 -T

ASI 30 electronic module is set to be used with TPR 280 gauge.

Measurement range: $5 \cdot 10^{-4}$ to 1000 mbar

Flange: DN 16 ISO-KF

TPR 280 gauges with other flanges: refer to Pfeiffer Vacuum book.



Technical characteristics

	Measurement range(*) (Helium)		Crossover pressure (at inlet)	
	mbar l/s	Pa m ³ /s	mbar	Pa
Gross Leak test mode	$8 \cdot 10^{-7}$ to $1 \cdot 10^{-1}$	$8 \cdot 10^{-8}$ to $1 \cdot 10^{-2}$	15	1500
Normal test mode	$1 \cdot 10^{-10}$ to $3 \cdot 10^{-4}$	$1 \cdot 10^{-11}$ to $3 \cdot 10^{-5}$	$5 \cdot 10^{-1}$	50
High Sensitivity test mode	$1 \cdot 10^{-11}$ to $2 \cdot 10^{-4}$ $5 \cdot 10^{-12}$ with zero function	$1 \cdot 10^{-12}$ to $2 \cdot 10^{-5}$ $5 \cdot 10^{-13}$ with zero function	$4 \cdot 10^{-2}$	4
Sniffing test mode	$1 \cdot 10^{-7}$ to $1 \cdot 10^{-1}$	$1 \cdot 10^{-8}$ to $1 \cdot 10^{-2}$	sniffer probe at atm. pressure	
Response time (Inlet port blanked off)			< 1 s	

* Zero function not activated, in standard conditions (20 °C, 5 ppm He ambient, degassed detector).

Gross leak test mode:

without zero function	$8 \cdot 10^{-7}$ mbar.l/s
with zero function	$8 \cdot 10^{-9}$ mbar.l/s

Technical data according to AVS 2.3 or EN 1518 or ISO 3530 standard

Helium pumping speed: Normal or High Sensitivity test mode

At inlet port	1.1 l/s
---------------	---------

Roughing primary pump characteristics:

Hybrid pump pumping speed (in air)	1.7 m ³ /h
------------------------------------	-----------------------

Turbomolecular pump characteristics:

Turbomolecular pump pumping speed (in air)	30 l/s
Turbomolecular pump exhaust pressure safety limit	45 mbar
Helium pumping speed	20 l/s

Analyzer cell (Spectro):

Analyzer cell design	self protected 180° magnetic deviation mass spectrometer
Analyzer cell filaments	2 Iridium filaments
Emission current range	0.2 to 2 mA

Display:

Inlet port pressure display range	10^3 to 10^{-3} mbar / 10^5 to 10^{-1} Pa
-----------------------------------	---

Technical characteristics

Set points adjustments:	85 dB modulated and adjustable audio signal
Hard vacuum Audio signal set point	Adjustable throughout the entire measuring range
Sniffing Audio set point	Adjustable throughout the entire measuring range

Start-up time (at 20 °C)

Without auto-calibration	< 2 min ± 10 %
With auto-calibration	< 3 min 30 s ± 10 %

Time to reach test mode:

	inlet port blanked-off	connected to 1.6 l volume	connected to 46 l volume
Gross Leak test mode	2 s	< 25 s	< 10 min
Normal test mode	4 s	< 35 s	< 20 min
High Sensitivity test mode	5 s	< 55 s	< 100 min

Miscellaneous:

Power voltage	90 - 240 V ± 10%
Power frequency	50/60 Hz single phase
Power consumption (maximum)	300 VA
Start-up temperature	10 to 40 °C
Ambient operating temperature	10 to 40 °C
Storage temperature	- 25 to 70 °C
Noise level (at 1 meter; audio alarm not operational, stand-by mode, after 1/2 h of use)	< 48 dBA
House protection level	IP 20
Inlet	DN 25 ISO-KF
Maxi couple to apply on the inlet part (any direction)	5 n.m
Humidity max. (at 40 °C)	95 %
Weight	< 48 lbs
Maximum weight of the tested part	5 kg / 11 lb

A 600

Dimensions (mm/feet)

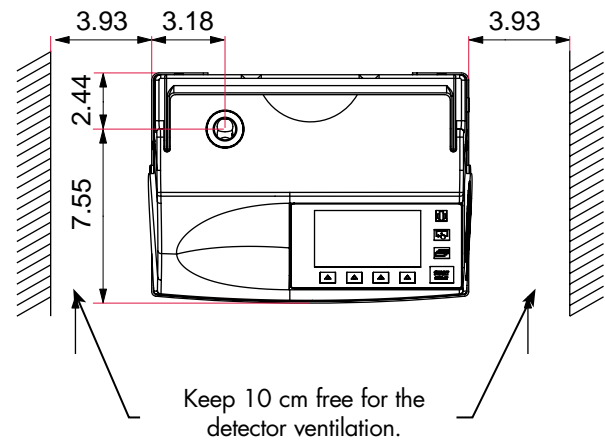
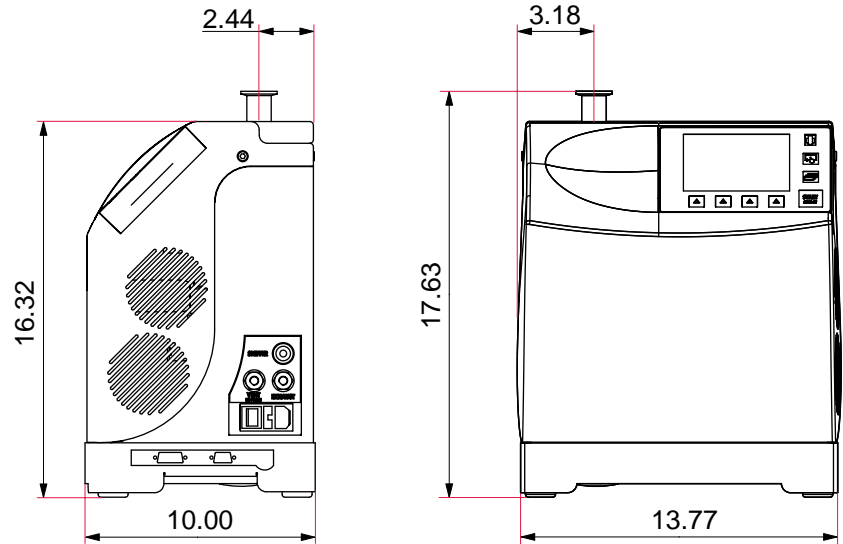



Installation

ASM 310 Operating instructions Detailed contents

Preliminary remarks

Throughout this operating manual, you could find this type of message **""Setting" menus arborescence**  **C 600**: it refers to a specific chapter of the operating manual. Please read it for further information.

B 100

Safety instructions

- Overview
- Storage
- Unpacking
- Installation
- Operation
- Maintenance

B 110

Unpacking - Storage - Transport

- Unpacking
- Supplies
- Storage
- Transport

B 112

Product labelling

- Detector packaging
- Detector
- Pumps

B 200

Neutral gas purge and inlet vent connection

- Purpose
- Connection to the leak detector
- Gas characteristics

B 300

Controlling the detector

- Proposed interfaces

B 301

RS 232

- Purpose
- Connection
- Use



Installation

ASM 310 Operating instructions Detailed contents

B 302

15 pin Interface

- Purpose
- Connection
- Use
- Analog Output

B 400

Start-up

- Connecting the detector to the installation
- Starting up
- Switching off recommended

Safety instructions

CAUTION

Indicates a potentially hazardous situation which, if not avoided, could result in property damage.

CAUTION

Indicates a potentially hazardous situation which, if not avoided, could result in moderate or minor injury. It may also be used to alert against unsafe practices.

WARNING

Indicates a potentially hazardous situation which, if not avoided, could result in death or severe injury.

DANGER

Indicates an imminently hazardous situation that, if not avoided, will result in death or severe injury (extreme situations).

Overview

Before switching on the appliance, study the operating manual and make sure you follow the safety instructions it gives. You can recognise these by the 'Caution', 'Warning' and 'Danger' symbols. Good practice tips and manufacturer's recommendations are in a blue box.

The performance and operational safety of this product are guaranteed provided it is used normally in the operating conditions defined in this manual.

It is the customer's task to:

- train operators to use the product if they do not speak the language the manual is written in,
- ensure operators know the safe practices to apply when using the product.

We took care to provide you with a clean appliance. To keep it in this condition, unpack it only in its final place of use.

For emergencies and breakdowns, contact the manager of your local service center (see addresses at back of manual).

Make sure the equipment shows no sign of transport damage. If it has been damaged, take the necessary steps to record this with the carrier and inform the manufacturer. In all cases, we recommend keeping the packaging (reusable materials) for further transport of the equipment or for prolonged storage.

Safety instructions

Our products are designed to comply with current EEC regulations. Users making their own modifications to the product are liable to break its compliance with these regulations, degrade its EMC (electromagnetic compatibility) rating, and make it unsafe to use. The manufacturer declines all liability for the consequences of such operations.

CAUTION

The product's EMC rating is obtained on the understanding that it is installed in compliance with EMC rules.

Of special note: in environments that are prone to emit interference,

- use shielded cables and connections on interfaces,
- put earthed screening on the power supply line, from the power source up to 3 meters (10 ft) from the product cable entry.

Storage

When storing the detector, please note that we guarantee the reliability of our equipment for three months in normal storage conditions (see operating manual for storage temperatures). Beyond this period, factors like temperature, humidity, or salt in the air can lead to deterioration of 'sensitive' items (elastomer, lubricant, etc.).

For storage longer than 3 months, follow the instructions in the operating manual.

Unpacking

Heavy detector

This product needs special handling precautions due to its weight. It should be removed from its crate only by staff trained in heavy materials handling:

- make sure the detector is stripped of all excess weight (accessories, customization, etc.) and the side covers are fastened,
- use the lifting rings provided with the product. The maker can not be held liable for the consequences of using other rings.
- screw the rings firmly home into the holes, provided, facing in the right direction to accept the slings,
- never lift the detector by means of a single lifting ring,
- the sling must not form an angle of more than 45 ° from vertical.

Installation

WARNING

Risk of tilting.

Although the appliance meets EEC safety regulations (normal range $\pm 10^\circ$), it is advisable to guard against the risk of tilting during handling, installation, and use.

ASM 380 detector.

When the detector is placed on a gradient of more than 3 ° (6 %), it can drag the operator along due to its heavy weight:

- use castors to move it,
- locate it on flat, hard ground,
- do not push it sideways or press on its side faces,
- do not leave objects leaning on the side of it.

The detector is not designed to carry people or loads and is not for use as a seat or step.

Safety instructions

Installation (cont.)

In leak detectors fitted with atmospheric air purging, avoid performing detection operations in non ventilated rooms. The helium concentration may be too high.

CAUTION

The leak detector must be installed on a horizontal flat surface and never laid on its side. Some models cater for other positions; these are described in the operating manual.

CAUTION

The leak detector is Class 1 equipment and therefore must be earthed. The user must check the electrical installation to which the leak detector is connected:

- it must comply with current standards (IEC 364),
- it must have a standards compliant earth wire, properly connected to earth.

WARNING

Electric shock hazard on touching.
When the main isolator is switched to the «0» position, items located between the mains connection and the isolator are still under mains voltage. Disconnect the mains cable from all power sources before commencing any maintenance work on the product.

WARNING

Electric shock hazard.
Some components have capacitors charged to over 60VDC. When power is switched off, they keep their charge for a time. Residual voltages from the filter capacitors can cause electric shocks all the way back to the mains plug. Wait 5 minutes after power-off before commencing any work on the appliance.

WARNING

A helium leak test must be performed in environmental conditions bearing no risk to the user or equipment (atmosphere neither in flammable, nor explosive). The user and/or OEM are ultimately responsible for ensuring proper safety conditions apply to the working product. The manufacturer has no control over the type of gas the detector is used with. Parts tested, equipment used, and the plant itself must show no trace of aggressive, chemical, corrosive, inflammable, reactive, toxic, explosive substances, neither condensable vapors, even in tiny quantities.
These are hazardous substances, and the process user must take responsibility for applying all relevant safety instructions in accordance with the legislation in effect at the site.
The detector's nitrogen purge system is not intended to dilute these gases. The manufacturer can not be held liable and the guarantee is void if the detector is used while these gases are present.

WARNING

Lock out (LO/TO) of nitrogen purging circuit.
The user will need to provide a dedicated Nitrogen circuit, fitted with a manual valve, that can be locked out within a radius of 3 m (10 ft) of the equipment.

Safety instructions

Operation

CAUTION

ASM 380 detector

This leak detector must not be used without its purge system. The user must make sure the purger is present and working properly.

The manufacturer shall not be held liable for any damage to the product and the guarantee is void if the purge does not work.

⚠ WARNING

The products are factory tested to ensure they will not leak in normal operating conditions. It is the user's responsibility to ensure this level of leak tightness is maintained.

⚠ DANGER

Explosion hazard.

To detect leaks using «hydrogen» tracer gas, always use hydrogenated nitrogen (95 % N₂ and 5 % H₂) (see chapter A of operating manual).

⚠ CAUTION

If the appliance is used in applications where dust or solid particles are present, we advise protecting it with an inlet filter (see section A of the operating manual).

Always use clean pipes and fittings in the pumping installation.

⚠ CAUTION

Make sure all parts and chambers connected to the inlet of our products can withstand a negative pressure of 1 bar below atmospheric pressure and that they are impervious to damage from vacuum (seals, etc.).

⚠ CAUTION

The inlet pressure must be no higher than atmospheric pressure. Too high a pressure can damage the product

⚠ WARNING

Remove the blanking plates on the inlet and exhaust orifices. These are to prevent foreign bodies entering the pump during transport and storage.

⚠ CAUTION

Make sure the exhaust pressure does not exceed 1200 mbar (absolute). Too high a pressure can damage the appliance.

After connecting the appliance to the pumping line, check for leaks along the whole of the line to ensure proper connections have been made (pump, pipes, valves, etc.).

Safety instructions

Operation (cont.)

CAUTION

Leak detectors fitted with oil seal roughing pumps. These pumps come without oil, which is delivered in separate drums. The material safety sheet for the oil is available upon request. Always wear gloves and goggles when filling the pumps with oil.

DANGER

The voltages and currents in use can induce electric shock. Isolate and lock out power to the appliance before maintaining it or removing the cover. Only skilled, authorized people may carry out maintenance work.

CAUTION

Risk of seizing
Avoid moving or applying shock to a running detector.
Portable detectors: avoid rotating the appliance about an axis perpendicular to the axis of rotation of the high vacuum pump.

CAUTION

ASM 380 detector.
Nipping hazard:
- keep hands away from the sides when opening the cover,
- keep hands away from the front of the cover when closing it.
Laceration hazard:
Do not move the appliance by holding the bumper bar. Use the handle provided.

Maintenance

The outside of the appliance and control box can be cleaned with a lint free wiper. Avoid using cleaning products that deteriorate printed surfaces and self adhesive labels. All other cleaning operations must be done by our service centers.

Whenever you return the product to an adixen repair service center, you must comply with the requirements of the «Procedure for returning adixen products» and fill in the safety questionnaire available in appendix chapter of the operating manual.

Safety instructions

Maintenance (cont.)



Do not eliminate maintenance waste via standard disposal channels. Have it destroyed by a qualified company if necessary.

Decontamination – product dismantling

According to the regulations 2002/96/CE about Waste of electrical and electronical equipments, and 2002/95/CE about Restriction of Hazardous substances, the manufacturer provides a recycling paid service for the end of-life of waste electrical and electronic equipment.

Any obligation of the manufacturer to take back such equipment shall apply only to complete not amended or modified equipment, using adixen Vacuum Products original spare parts, delivered by adixen Vacuum Products, containing i.e. all its components and sub-assemblies.

This obligation will not cover the shipping cost to an adixen take back facility. Before returning the product, fill in the safety form available in appendix of the operating manual. Attach it to the product before shipping to the service-repair office closest to you.

CAUTION

Leak detectors fitted with oil seal roughing pumps.

We advise draining the pump prior to any transport of the equipment.

Always wear gloves and goggles when draining the pumps.

Do not put waste oil down the drain. Have it destroyed by a qualified company if necessary.

WARNING

Maintenance must be performed by a skilled maintenance operator trained in the relevant health and safety aspects (EMC, electrical hazards, chemical pollution, etc.).

Isolate the product from all energy sources (mains electricity, compressed air, etc.) before starting work.

Major overhauls must be performed by qualified staff who have received training from the manufacturer, especially when it comes to handling the fluids inside the detector (see instructions in operating manual).

WARNING

The products are designed to avoid subjecting users to heat hazards. Specific operating conditions can nevertheless exist that require extra caution from users due to the high temperatures generated (outer surfaces > 70° C):
Wear protective gloves to work on the appliance, especially during maintenance.

Unpacking - Storage - Transport

Unpacking

When the equipment is received, unpack it carefully: do not discard the packaging until you have made sure that the unit has not been damaged during transport. Yet, we advise to keep it for a possible transport. Check **the shock indicator** of the detector. Before opening, check the **name of the model** and the **serial number**.

In the event of an anomaly, take the necessary action with the skipper and notify if necessary.

To get out the detector of its packaging, proceed in the following way:



①

Free the detector handle and pull it to the back.



②

Revolve the handle. If it is stuck, you don't pull it enough to the back.



③

Raise the detector.

Weight: see  **A 500**.

If you use a hoist to get out the detector, indeed position the hooks of this one in notches planned for that purpose on the handle.

Supplies

The following parts are supplied with your detector:

- a documentation kit.
- a calibration certificate of the internal calibrated leak, stapled inside the operating manual.
- 1 SD card (inside the control panel)
- 1 maintenance kit.
- 1 plug Sub D 15 pts not wired for I/O.
- Power supply cord France and US (other power supply cords :  **A 400**).

Unpacking - Storage - Transport

Storage For prolonged storage, factors such as temperature, humidity, saline atmosphere, etc. may damage the detector elements.

Please call your local representative for further information.

Before starting up after storage for over six months, it is recommended to change all the seals (contact customer service).

The seals kits must be kept away from heat and light (direct sunlight and ultraviolet light) in order to prevent hardening of the elastomers.

Transport We advise to use the transport case specially designed for the ASM 310.

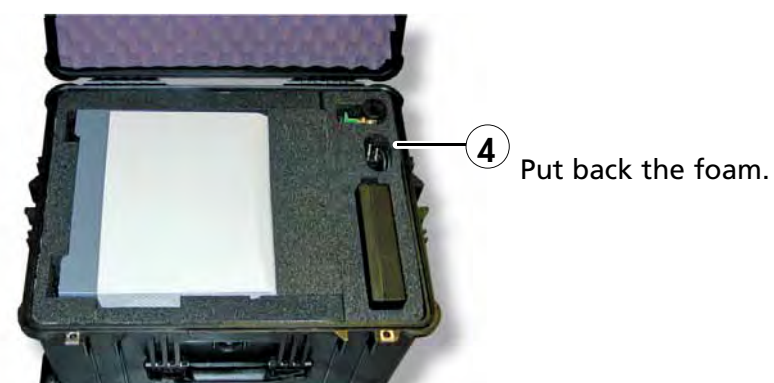
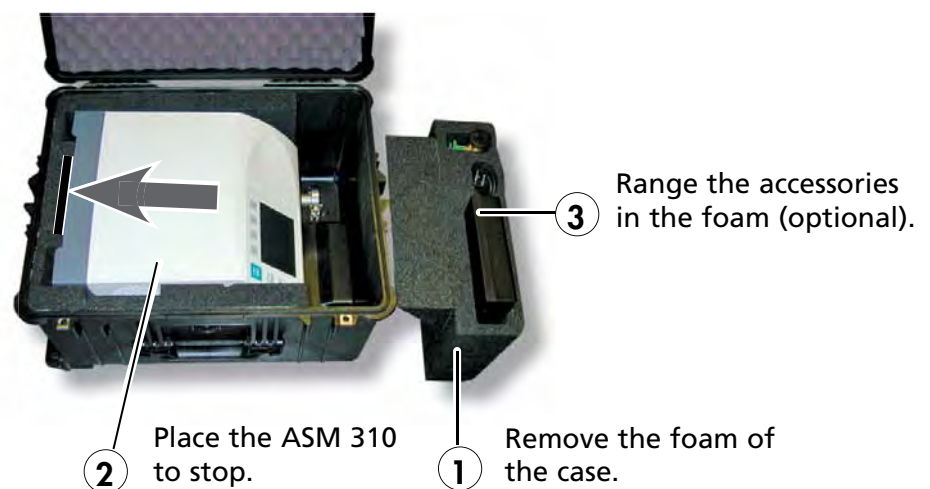

Product labelling

Detector packaging

- Marking on the packaging used for product delivery.

WARNING

WE RECOMMEND KEEPING THE ORIGINAL PACKAGING (REUSABLE MATERIALS) FOR FURTHER TRANSPORT OF THE EQUIPMENT.

CONSULT THE OPERATING INSTRUCTIONS BEFORE PRODUCT UNPACKING.

ATTENTION

NOUS VOUS RECOMMANDONS DE CONSERVER L'EMBALLAGE D'ORIGINE (MATERIAU RECYCLABLE) POUR TRANSPORTER L'EQUIPEMENT.

CONSULTER DE L'UTILISATEUR AVANT DEBALLAGE DU PRODUIT.

ACHTUNG

WIR RATEN IHNEN DIE ORIGINALVERPACKUNG (WIEDERVERWERTBARES MATERIAL) FÜR EINEN SPÄTEREN TRANSPORT AUFZUBEWAHREN.

VOR DEM AUSPACKEN, DER BETRIEBSANLEITUNG LESEN UND BEACHTEN.

- Shock indicator: indicates if the box has been shook.

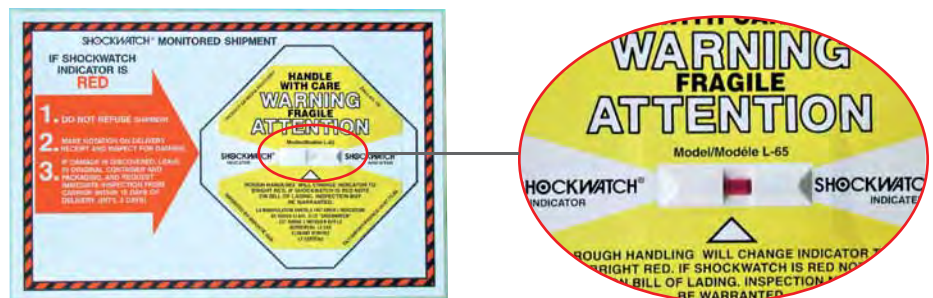

- Tilt indicator: indicates that the box has been tipped.

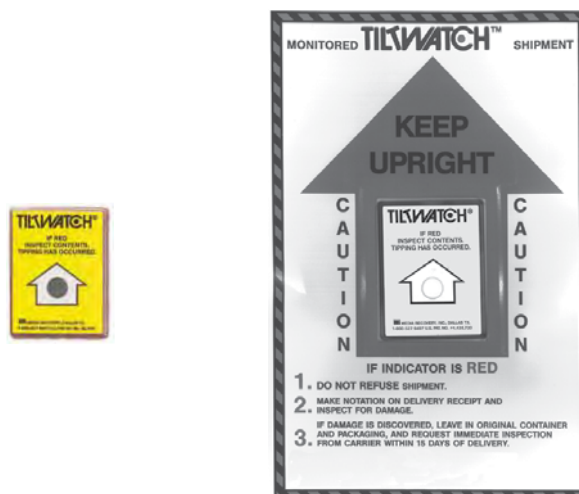

- Safety label: guarantees that nobody has opened the packaging since the manufacturing departure.



Product labelling

- Detector**
- Located on the frame, identity label indicates:
 - General data allowing identifying the leak detector.
 - Safety data allowing using the leak detector in good conditions.



1	Part number
2	Designation
3	Net weight
4	Use voltage
5	Use frequency
6	Maxi power consumption
7	Serial number
8	Index
9	Manufacturing date

- Product customized in factory, according to customer order.

**PRODUIT PERSONNALISÉ
CUSTOMIZED PRODUCT**

- Located on the frame, this label indicates if “Bluetooth”, “Input/output board with Ethernet” or “Input/output board with Wi-Fi” options are placed in the detector.
If yes, their Mac addresses, required for their configuration, are indicated.

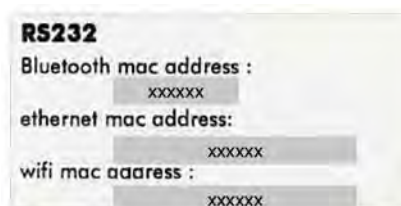

Product labelling

- Located on the frame, under the cover, this label indicates for each firmware load in the leak detector, its version and checksum.

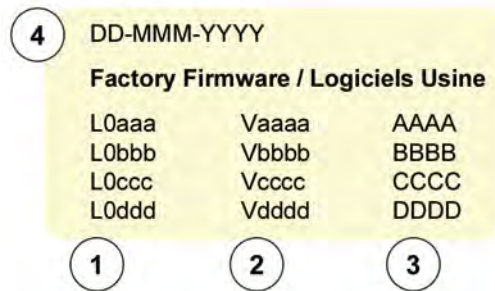

1	Firmware name
2	Firmware version
3	Firmware checksum
4	Label edition date

- Located on the frame, under the cover, this label indicates parameters values only necessary to Service Centers for the leak detector maintenance.

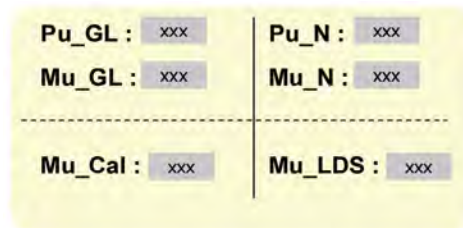

- Leak detector quality control comply at factory leaving.

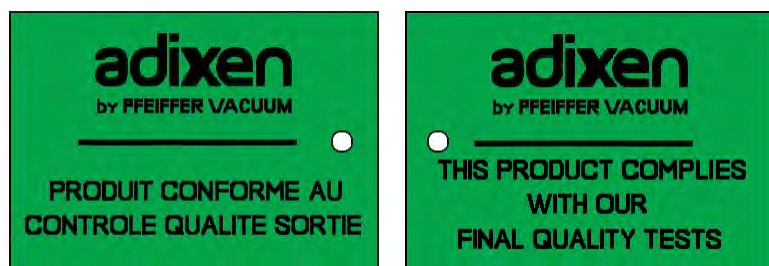

- Leak detector conformed with the R.O.H.S. directives.



Product labelling

- Located on the detector, this label indicates that the product lifting must:
 - be made from the handling points identified with this label (rings, handles, ...),
 - respect the handling rules book considering its weight and dimensions.
 - See Operating Instructions for more details.

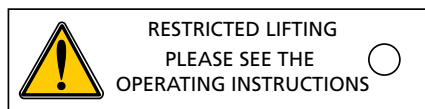

- Don't move the leak detector in operation in all positions.

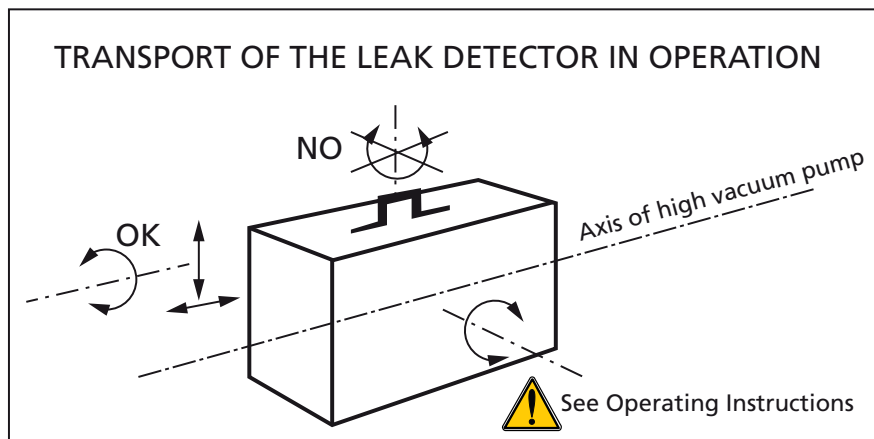

- Exhaust port: not to be blocked.

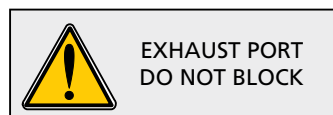

- Product drained before leaving factory: fill the primary pump with oil before running.

NOTICE
PUMP IS SHIPPED WITHOUT
 ○ **OIL INSTALLED**
 consult maintenance manual
CAUTION

ATTENTION
POMPE LIVREE SANS HUILE
 ○ **A L'INTERIEUR**
 consulter le manuel d'utilisation
ATTENTION

Product labelling

- This label indicates a detector ground point.



- Located on some electronic boards, this label indicates that some of the internal parts are energized and could cause electrical shocks in case of contact.



- Located on the frame, this label indicates that some of the internal parts are energized and could cause electrical shocks in case of contact. This label recommends disconnecting power supply cable and waiting 5 minutes before any maintenance operation.

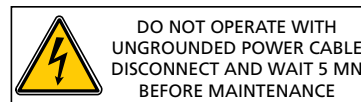

- Located on some electronic boards, this label indicates that some of the internal parts are energized and could cause electrical shocks in case of contact. This label recommends:
 - Do not using the leak detector with the power supply cable not connected to the ground,
 - disconnecting electrically the leak detector before any maintenance operation.

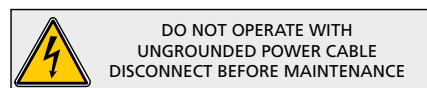

- Located on some electronic boards, this label indicates that some of the internal parts are energized and could cause electrical shocks in case of contact. This label recommends disconnecting electrically the leak detector before removing the cover.



Product labelling

Pumps

- Located on the rear of the pump, this label warns the user against possible risk of injury due to any hand contact with hot surfaces. It states that protective gloves should be used before performing any intervention.



- Located on the upper cover, this label indicates that due to its heavy weight the product should not be handled manually, but always through appropriate handling devices.



- Located on the upper cover, this label indicates that some of the internal parts are energized and could cause electrical shocks in case of contact. It advises to disconnect the pump before any intervention or to properly lock-out and tag-out the equipment breaker before any intervention on the pump.

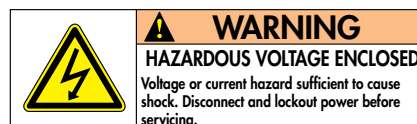

- Located on the upper cover, this label informs the user that moving parts present inside the pump could cause personal injury, like crushing or cutting. The user must keep all body parts away from moving parts.



Neutral gas purge and inlet vent connection

Purpose

Neutral gas purge

- Used to accelerate the cleanup of the helium background noise in the pumps after detecting a significant leak.
- Make High Sensitivity tests easier due to the reduction and stabilization of the helium background noise.
- As a supplement to the neutral gas purge, use the “He max” function ( C 401).

Inlet vent

- Vent the inlet of the detector and the connected part to atmospheric pressure.
- Could be used to accelerate the cleanup of the helium background noise in the leak detector after detecting a significant leak.

Connection to the leak detector

The neutral gas purge and the inlet vent are connected on the same port: the same gas is used for both (ambient air or neutral gas).

 B 300.

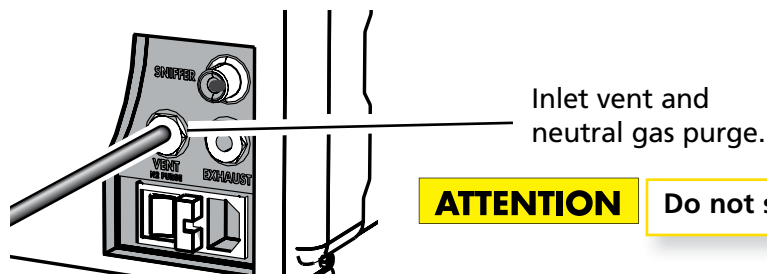

Neutral gas purge

- If no purge system is connected, the gas purge is connected to the ambient air and maintains an air flow inside the leak detector.
- The neutral gas purge status (open or closed) depends on the software. No parameter can be changed by the operator.

Inlet vent

- The inlet vent status (open or closed) depends on the parameters set by the operator ( C 500).
- If no inlet vent system is connected, the inlet vent is connected to the ambient air.

Neutral gas purge and inlet vent connection

Gas characteristics

Type Dry nitrogen is typically the neutral gas used but you can use any gas on the condition that it is low in helium (concentration ≤ 1 ppm).

Ambient air should not be polluted with helium: no detection in a not airy room.

Quality/purity According to the installation or item to test, the gas should be clean, dry, without dust, and non toxic.

Purge flow ≈ 5 sccm

Use pressure

- 0.1 to 0.3 bar relative (≈ 1.5 to 4.5 psig),
- 1.1 to 1.3 bar absolute (≈ 16 to 20 psia)

If the purge gas pressure is too high, the inlet valve could always be stay closed.

Controlling the detector

Proposed interfaces

- Standard interface
- ① RS 232 (📖 B 301)
 - ② 15 pins interface (📖 B 302).

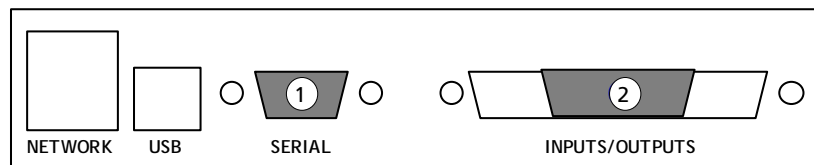

RS 232

Purpose The RS 232 interface allows to control the leak detector with a PC compatible computer.

Connection Refer to  **B 400**.

The Sub D 9 pin femelle connector is at customer's charge.



- Use**
- It is necessary to allocate RS 232 to serial link 1 in the control panel advanced menu ( **C 406**) to activate it.
 - Refer to the RS 232 specific operating manual supplied with the leak detector operating manual.

15 pin Interface

Purpose The 15 pin Input/Output interface allows to control the leak detector with a programmable logic controller or any other external control device.

It also allows to get back a 0 - 10 V signal (1 V/decade) corresponding to the leak flow measurement.

Connection Refer to  **B 400**.

The 15 pin male connector and its cover are supplied with the leak detector.

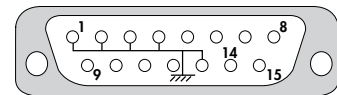

CAUTION

It is recommended to use a shielded cable which is grounded on the connector cover.

Use

Inputs	Digital	14	Cycle start
	Analog	5	Not activated
Outputs	Digital	6	Selected test mode reached
		7	Reject point threshold crossed
	Analog	9	Mantissa (0/10 V)*
		10	He signal (logarithmic) (*)
		11	Not activated
		12	Exponent (0/10 V)
Ground			1 - 2 - 3 - 4 - 13
Headphones		8	Headphones + ⁽¹⁾
		15	Headphones - ⁽¹⁾

(*) By default ; Adjustable by the user.

(1) To activate audio/headphones output, it is necessary to send "=HPD" RS 232 command to the leak detector : this command deactivates the loudspeaker.

To deactivate audio/headphones output, it is necessary to send "=HPE" RS 232 command to the leak detector : this command activates again the loudspeaker.

15 pin Interface

- Analog Output**
- 2 adjustable analog outputs. For each, user can set its allocation and, if necessary, the start decade (scale start). There is also 1 fixed output (19-ground) for the exponent.

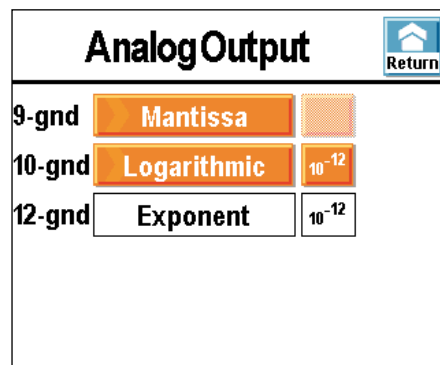

Possible values for each output:

Value	Function
Mantissa	1/10 V (*)
Exponent	0/10 V – Low decade to set (*)
Logarithmic	0/10 V - Low decade to set (*)
Inlet pressure	If a pressure measurement gauge is installed in the customer installation (at the customer's charge) (*) 2,5 V/8,5 V (10 ⁻³ to 10 ⁺³ mbar)
He compound	0/10 V (compound exponent, mantissa)

(*) Graphs and formulas in appendix: G 300

After modification, we advise to save all inputs/outputs set.

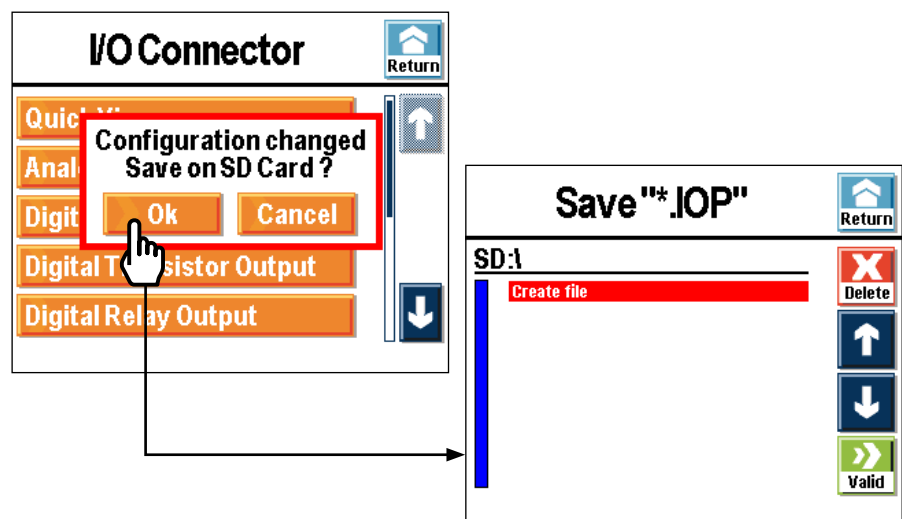

Start-up

Connecting the detector to the installation

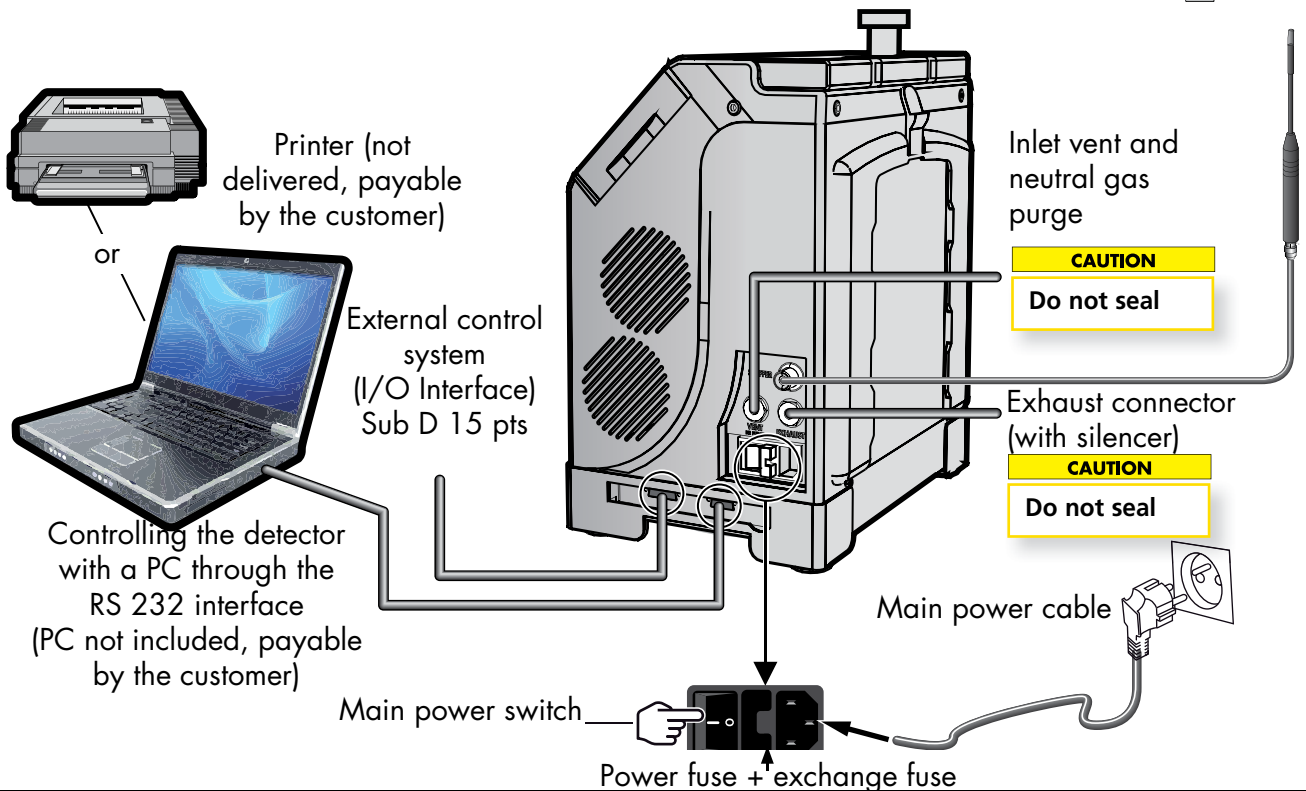
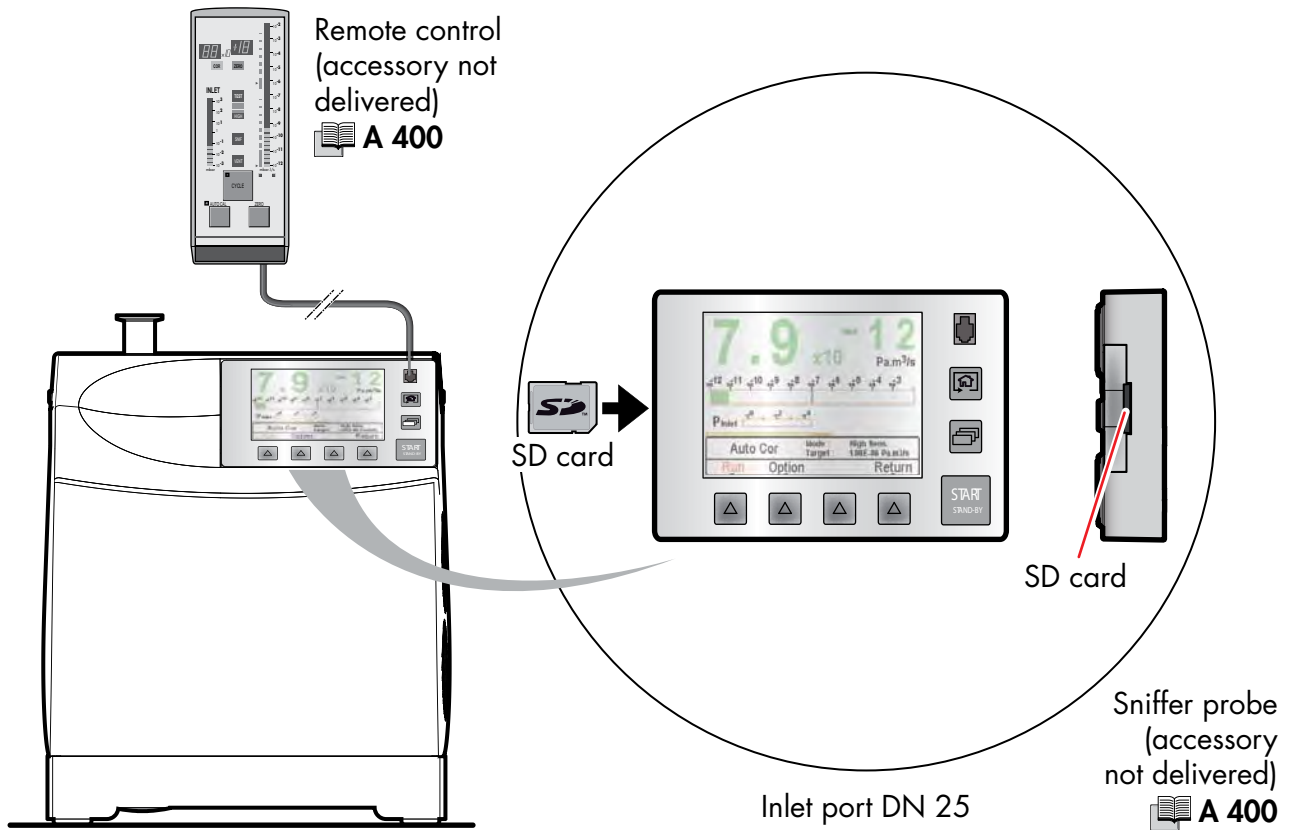

Start-up

Basic vacuum rules for the installation connecting

- We recommend connecting the leak detectors using pipes in stainless steel with a diameter equal to the inlet port.
- The connection between the piece to be tested and the leak detector must be as short as possible, direct, perfectly tight (which means it is important to design adapted tools to connect the piece).
- The volume between the tested part and the test chamber (free volume) must be as small as possible.
- The length of the connection influence the "response time". It means that if the connection is very long (more than 1.5 meter with diameter equal to the inlet of the detector) the signal will move more slowly.
- Don't use plastic flexibles as compressed air tubes.
- Check carefully that the material doesn't allow helium permeation.

Use positions

The leak detector could be use in a horizontal position: turn the control panel for a better reading.



Position the leak detector so that there is no risk of fall or shock.



Start-up

Cart fixing The cart is an accessory purchased separately: fix it on the leak detector.



Control panel fixing The control panel fixing allows to lock it (the operator could not remove it) and possibly to disconnect it from the leak detector in particular in case of leak detector use in vertical position. It also makes the SD card access inaccessible. The control panel could also be fix on all other supports thanks to 2 nuts embed in the plastic hull.

Start-up

- Starting up** Your leak detector is multivoltage (from 90 to 240 V \pm 10 %): connect it to the power plug.
- 1st starting up** During the first starting up after reception, you can adjust the unit, the date, the hour and the language of the displays and the digital voice.
These parameters can afterward be modified if necessary.
( **C 303**).
- Starting up after an unused/ storage period** After an unused storage period, there is additional time at the start-up for outgassing.
The countdown before using the leak detector is displayed.
The operator can cancel this additional time by pressing . But it is not recommended. It is not abnormal that after an unused storage period, the calibration fails. In this case, wait 30 minutes and do it again.
- Cold starting up** In case of starting up in too low temperature, there is additional time at the start-up for outgassing and some components reheating.
The countdown before using the leak detector is displayed.
The operator can cancel this additional time by pressing . But it is not recommended.
- Getting started with the leak detector** If you have never used a leak detector, know that there is no risk of starting your detector and discovering the menus even without particular knowledge. But we advise to read chapters B and C.

If you have already used this type of product, do not hesitate to discover the menus by yourself. Read the chapter C.

Start-up

Switching off recommended

The leak detector can be switched off at any time by depressing the main power switch to 0 (OFF) but it is advised (especially when the leak detector may not be used for an extended period of time) to stop it following the procedure described below.

- Place the blank-off flange or close the test chamber.
- Start a test cycle.
- Wait until the leak detector reaches the more sensitive test mode
Make sure that the inlet vent is OFF.
- Stop the test cycle.
- Stop the leak detector.
- Wait before moving the detector so as to make sure of the complete turbomolecular pump stop.

The leak detector is so under vacuum avoiding an important degassing time in a future use.



ASM 310 Operating instructions Detailed contents

Preliminary remarks

Throughout this operating manual, you could find this type of message **""Setting" menus arborescence**  **C 600**: it refers to a specific chapter of the operating manual. Please read it for further information.

C 100

Getting started with the leak detector

- Start/stop a test
- To familiarize oneself with the control panel

C 110

Perform a test

C 200

Control panel

- Description
- Applicative windows
- Function keys

C 300

Graphic display

- Purpose
- Setting
- Deletion
- Recording
- Recording visualization
- Plotting saving

C 400

Settings

- Purpose
- Legend
- Value adjustment from the control panel

C 401

Set points Menu

- Purpose
- Audio alarm and digital voice set points
- He max.
- Set points
- Probe clogged



ASM 310 Operating instructions Detailed contents

C 402

Test Menu

- Purpose
- Test methods
- Correction factor
- Test mode
- Cycle end function
- Air inlet

C 403

Spectro Menu

- Purpose
- Tracer gas
- Fil. Margin
- Calibrated leak

C 404

Maintenance Menu

- Purpose
- Filament 1-2
- Cycles counter
- Primary pump - Secondary pump
- Events history
- Calibrations history
- Infos

C 405

Configuration Menu

- Purpose
- Hour / Date / Unit / Language
- Function Keys
- Applicative windows
- Screen settings
- Access Password

C 406

Advanced Menu

- Purpose
- Leak detection menu
- Leak detection: start-up time delay
- Leak detection: Memo function
- Leak detection: Background suppression function
- Leak detection: Calibration
- Leak detection: Analyzer cell
- Leak detection: Internal Pirani gauge calibration
- Input/Output menu
- Input/Output: COM serial port
- SD card menu
- Load/Save Detec. Param.



ASM 310 Operating instructions Detailed contents

C 500

Factory configuration of the leak detector parameters

- Parameters configuration

C 600

"Setting" menus arborescence

C 700

Remote control (accessory)

- Interface
- Connecting
- Choice
- Use and display

C 900

Long distance sniffer probe and Helium spray gun (accessories)

Getting started with the leak detector

Safely for your leak detector and yourself, you can realize quickly a vacuum test and discover your leak detector.

Refer to the sheet  **B 300** for the installation and detector starting up in case of doubt.

Start/stop a test

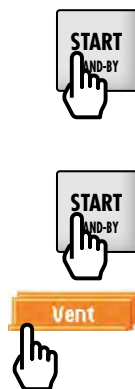

- Place the blank-off flange on the detector inlet (detector state on delivery).

- Start a test.

- The helium signal displays the measured leak value: it corresponds in our case to the detector background.

- Stop the test.

- To remove the blank-off flange, do an air inlet ( **C 402**).

To familiarize oneself with the control panel

Refer to the sheet  **C 200** for the control panel description.



- Press on the key  several times to familiarize with the application windows.



- Press on the key  several times to discover the 3 function keys levels proposed.













- At each level, press on each function key (on the control panel or with the key  opposite) to discover its action.

Perform a test

By default, the leak detector is set to perform a helium hard vacuum test, in the most sensitive test mode.

2 tests modes are proposed: hard vacuum and sniffing ( A 200).

Hard vacuum test mode	Sniffing test mode
 Select the hard vacuum test mode ( C 402).	 Select the sniffing test mode ( C 402).
Connect the part to be tested to the leak detector inlet port or put the part in the test chamber connected to the leak detector.	While the leak detector is in stand-by, connect the sniffer probe (accessory to be purchased separately) to the sniffer port of the leak detector.
 Set the reject point ( C 401).	
 Start a test.	
The leak value measured displays.	
 Stop the test. The detector returns automatically to stand-by mode.	
If Memo function is activated and a printer is connected to the detector, a test ticket will be printed automatically after the test ( C 406).	

- Notes**
- In stand-by mode, the leak value displayed is the helium background value.
 - If the automatic cycle function is activated, the test end is different ( C 304).

Control panel

Description

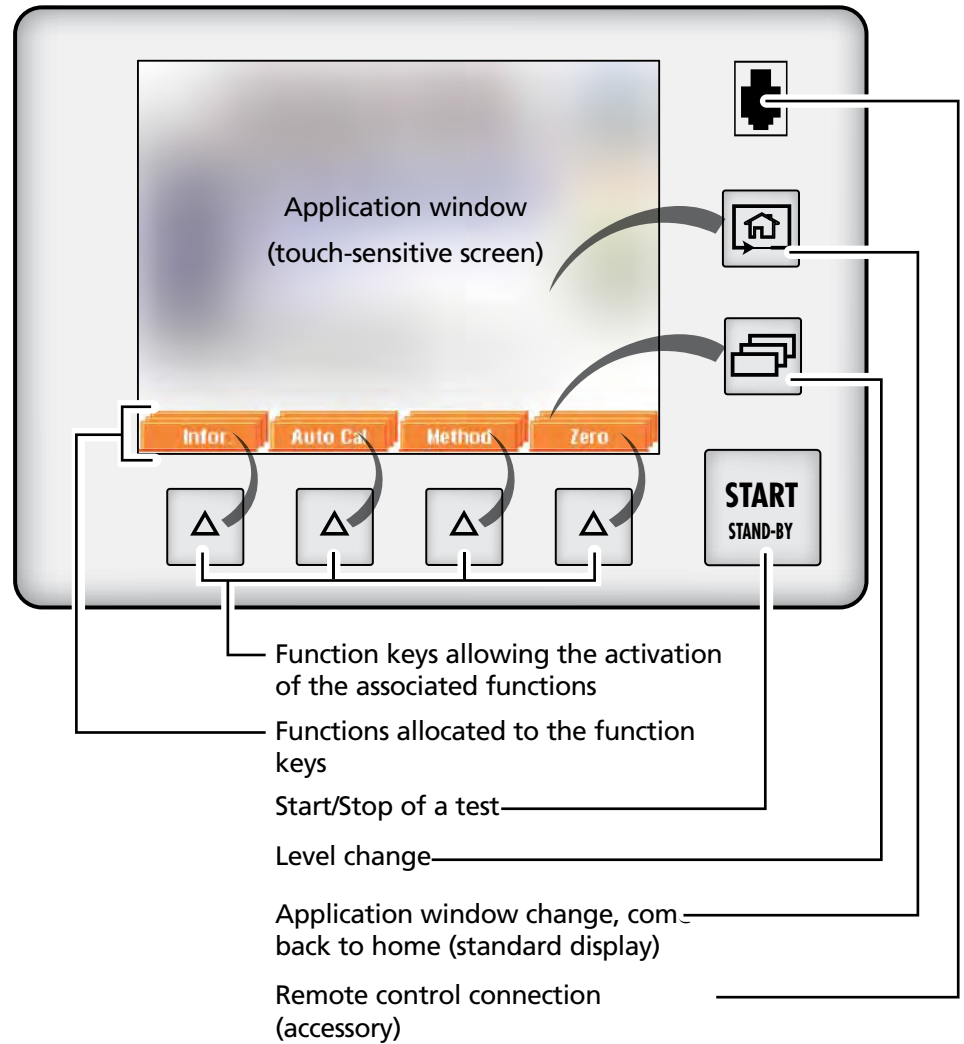

Use a finger or any object with end rounded off on the touch-sensitive screen. Do not use sharp objects (screwdriver for example).

Contrast/Luminosity

C 403

Screensaver

C 405

Any press on the screen will reactivate the display.

If the touch-sensitive screen is defective, the functions remain accessible by keys: use the RS 232 to pilot/set the detector or the SD card (setting only).

Control panel

Application windows

Standard display Inform the operator of the test

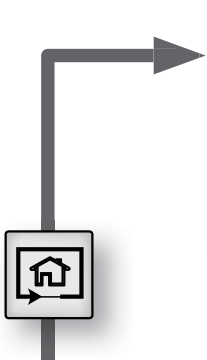
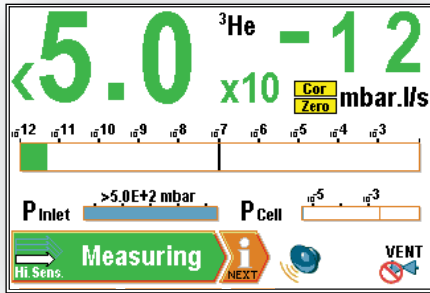

Setting Allows the operator to set/ configure the detector according to its needs

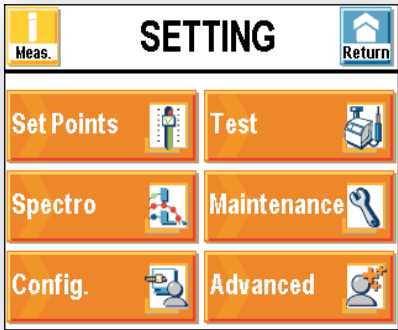

Graphic display Allows the operator to follow and to record the He signals and the pressure according to time

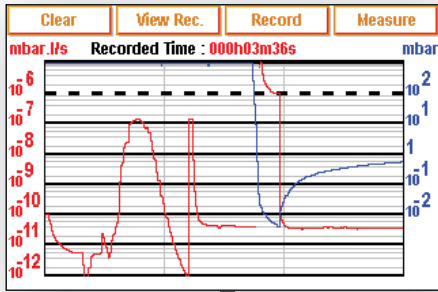

Vacuum circuit Indicate to the operator the leak detector vacuum circuit as well as the valves state.

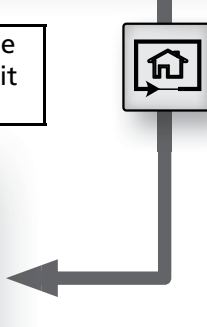
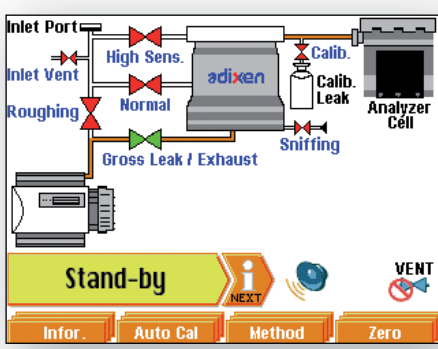

The operator can mask, add, switch some windows in the loop **C 403**.

The operator can have only a single application window displayed.

Control panel

Standard display Display most generally used to do a test.

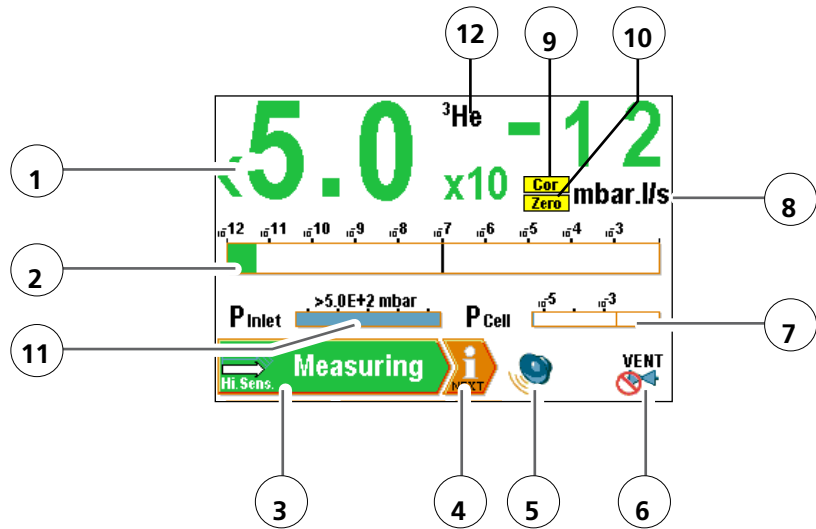



1	He signal digital display (green \leq reject set point $<$ red)
2	He signal bargraph display (adjustable scale)
3	Detector state and detection mode
4	Default information access
5	Mute function activated/desactivated indicator
6	Inlet vent function activated/desactivated indicator (📖 C 402)
7	Cell pressure bargraph display
8	Measure unit of the leak flow
9	Signal correction function activated indicator
10	Zero function activated indicator
11	Detector inlet pressure display (coherent unit with the leak flow unit)
12	Tracer gas (if ^3He or H_2)

Control panel

Graphic display C 300

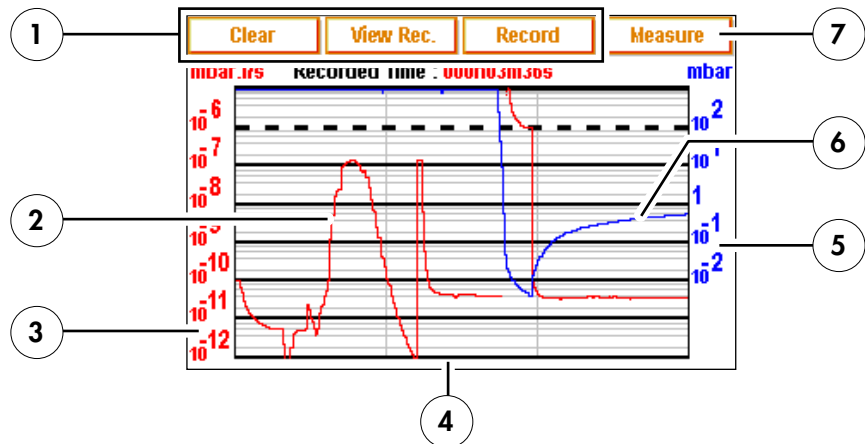
Display used to facilitate the tests requiring a high precision, by showing the measured signal and its evolution.



1	Delete/visualisate/record graph
2	Tracer gas signal display (in red)
3	Tracer gas signal scale (in red)
4	Time scale
5	Inlet pressure scale (in blue)
6	Inlet pressure display (in blue)
7	Measure/masking display:  → 

Vacuum circuit

Display used to follow the valves state during a test and so to have a better knowledge of the detector functioning.

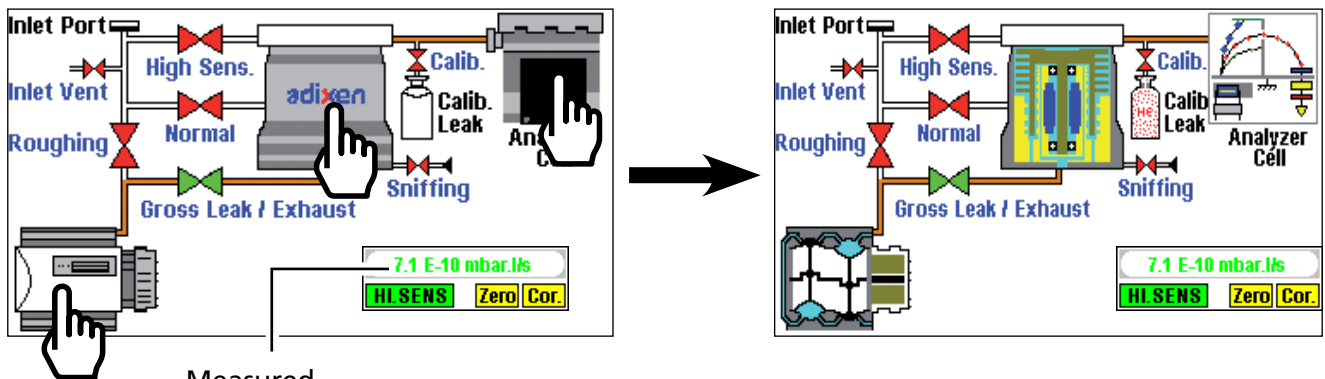

Measured signal digital display

The vacuum circuit varies according to the detector state:

- green: valve opened
- red: valve closed.





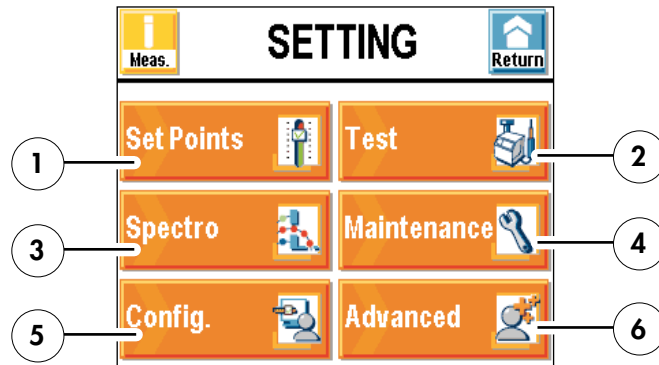

It is not possible to control valves.

Control panel



 **Setting**
C 400... C 406

Menu allowing the detector setting access.



1	Set points setting: reject set point, audio level, digital voice, He max.	 C 401
2	Method and test mode selection. Inlet vent management. Correction value. Cycle end.	 C 402
3	Filament management, tracer gas selection. Calibrated leak setting.	 C 403
4	Maintenances planning	 C 404
5	Detector configuration for the user: language, unit, password, function keys, applicative windows	 C 405
6	Advanced functions* kept for specific detector uses. It is necessary to read the operating manual. *advanced setting required a good leak detection knowledge: cell setting, pressure gauge, etc.	 C 406



- "Setting" menu is also accessible from any window by pressing simultaneously the keys  and .

Control panel

"Measure" display This window could be display as soon as the key  is displayed.

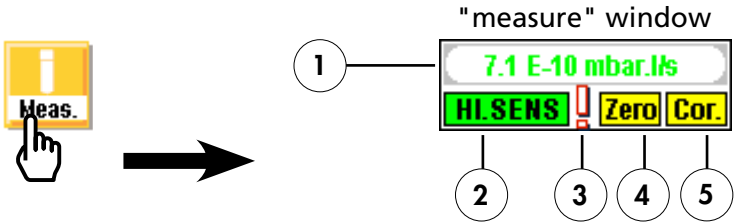

1	He signal digital display (green \leq reject set point $<$ red)
2	Detector state
3	Default information indicator
4	Zero function activated indicator
5	Signal correction function activated indicator

The operator could move the "measure" window on the touch-sensitive screen: press on the measure window with the finger and move this one on the screen.

Control panel

Function keys 12 function keys, customized by the operator, divided on 3 lines allow:

- either activate directly the function, without use "Setting" menu,
- or adjust a set point,
- or display informations,
- or give or not the access to a limited number of functions.

3 standard configurations are proposed meeting the majority of the user's need (📖 C 405).

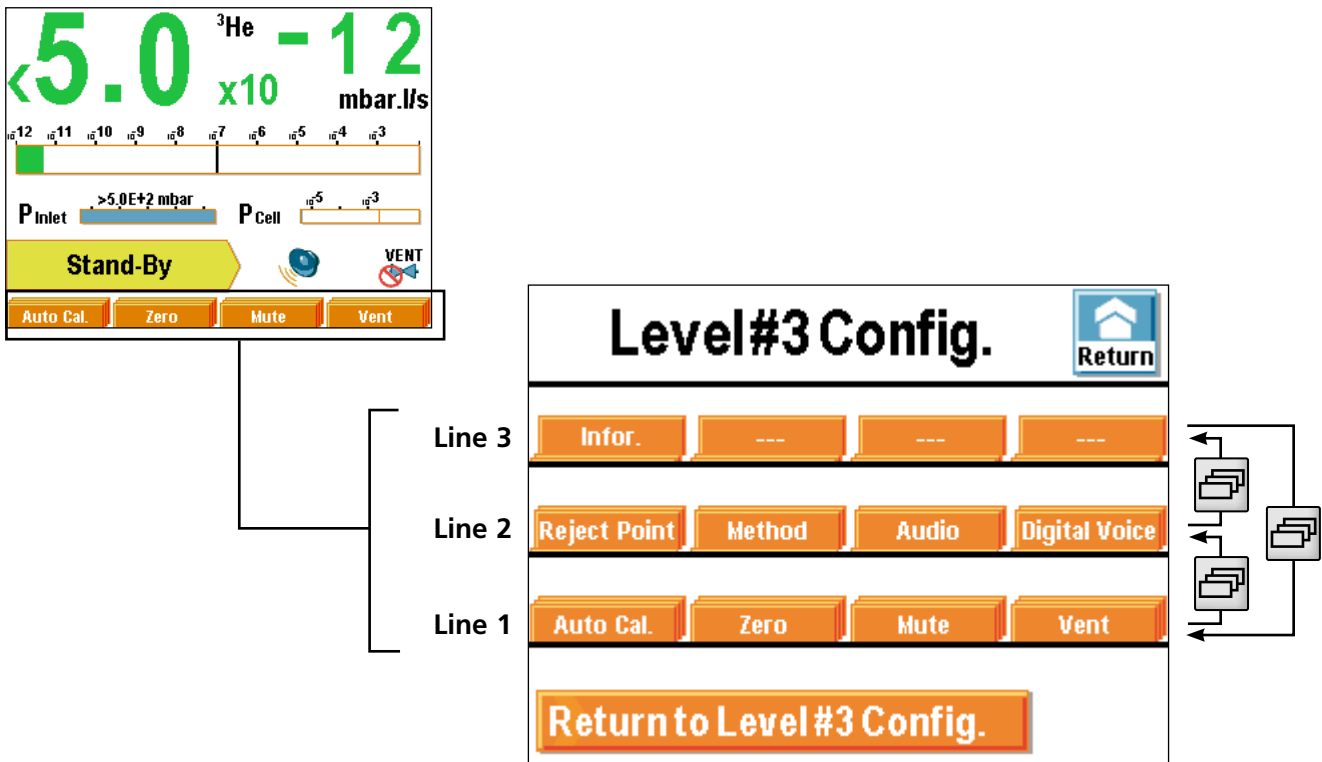

If necessary, the operator can customize the function keys. 📖 C 405.

Graphic display

Purpose Graphic display allows to the operator to follow the measured signal and/or inlet pressure evolution in the time and to record it.

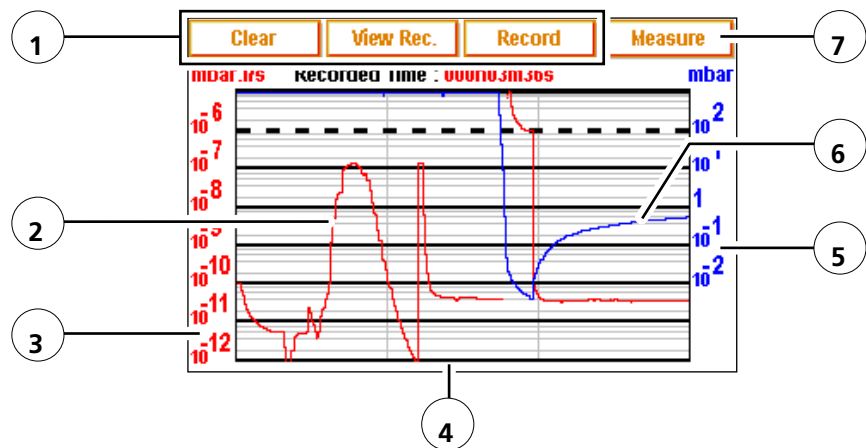

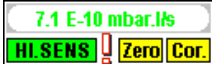
1	Delete/visualize/record a plotting
2	Tracer gas signal display (in red)
3	Tracer gas signal scale (in red)
4	Time scale
5	Inlet pressure scale (in blue)
6	Inlet pressure display (in blue): pressure = 10^3 constantly if there is no external gauge connected
7	Measure displayed/hidden:  → 

- Scales (3), (4), (5), are adjustable by pressing on the graph.
- The operator could move the "measure" window on the touch-sensitive screen: press on the measure window with the finger and move this one on the screen.

Graphic display

Setting Access to the graph setting menu by pressing on the graph.

Display

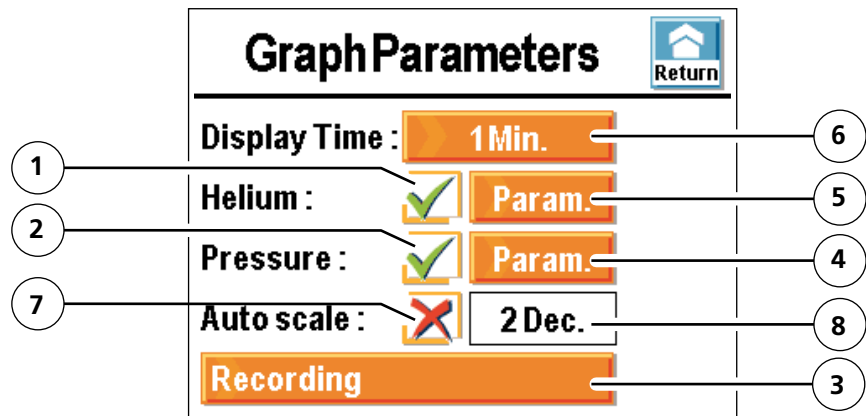

1	Display/mask the measured signal
2	Display/mask the inlet pressure
3	Recording time parameters
4	Inlet pressure scale parameters
5	He signal scale parameters (if automatic scale deactivated)
6	Screen display time speed
7	Activate/Deactivate automatic scale
8	Automatic scale setting

Automatic scale Automatic scale allows displaying measured signal centred on 2 or 4 decades.

Scale moves in function of measured signal. If automatic scale is set, it is no more possible to set the He signal scale (1):

Example : He signal = $5 \cdot 10^{-7}$ mbar l/s

- automatic scale 2 decades → scale from $5 \cdot 10^{-6}$ to $5 \cdot 10^{-8}$ mbar l/s
- automatic scale 4 decades → scale from $5 \cdot 10^{-5}$ to $5 \cdot 10^{-9}$ mbar l/s

Graphic display

Recording

GraphParameters Return

Display Time : **Fast**

Helium : **Param.**

Pressure : **Param.**

Recording

Recording Return

Samp. Time : **0,2 Sec**

Capacity : **6h33m25s**

Recording total time according to the sample time

Sample time

Sample time	Maximum capacity	File size
0.2 s	6 hours 33 minutes	≈ 7 Mo
30 s	983 hours	

Graphic display

Deletion  Deletion of the screen in progress.

Recording Recording allows to record measure points in the control panel: **it does not save these points.** (see § "Saving the recording").

The recorded points will be lost if the leak detector is switch off: if necessary, save the recording them on the SD card.



- Change if necessary the recording parameters.

- Start a recording 

All points displayed on the graph before the recording start will not be recorded.

- Stop recording 

- To display recording 

- If the memory is not delete between 2 recordings, (), all the successive recordings are consecutive on the recorded graph. A cursor  indicates the end of each recording.

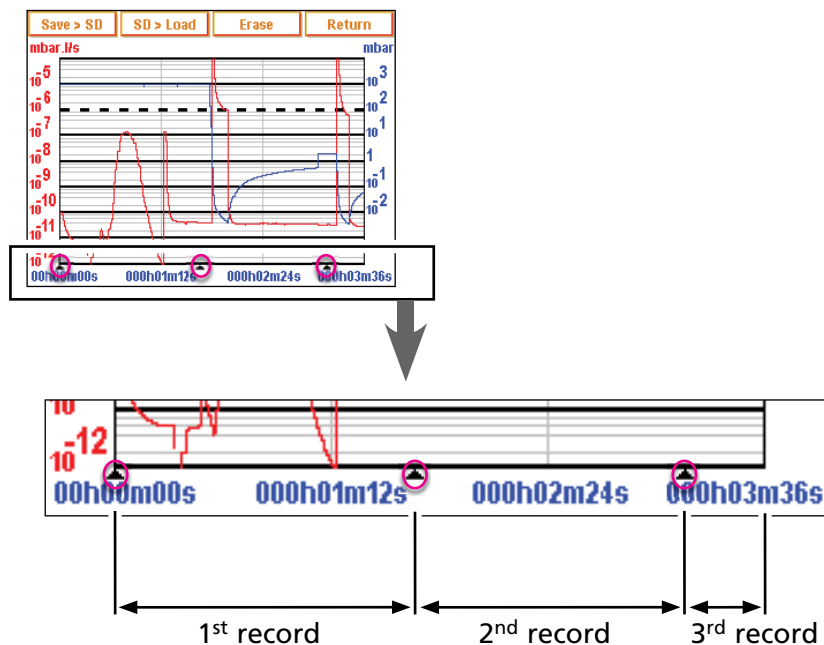

Graphic display

Recording (ctd)

- When the memory is full and if a recording is in progress, recording is automatically stopped and the message below displays:

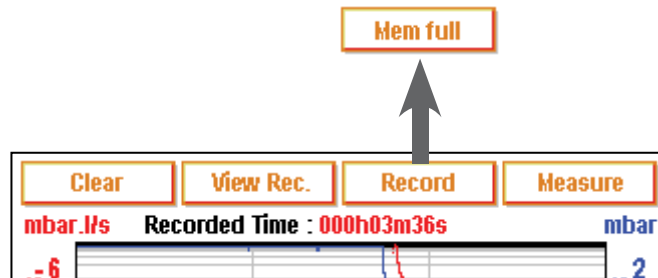

- During a recording, all the detector functions are available.
- Every detector switching off or control panel disconnection will delete the memory: if necessary, save the recorded plotting on the SD card before these operations.

Recording visualization



- At any time, during a plotting, the operator can visualize a plotting part already recorded or do a zoom, without stop the plotting in progress.

View Rec. Visualisation of the plottings recorded done since the last **Clear** or the last switching on.

View Rec. Visualisation of a plotting realized.

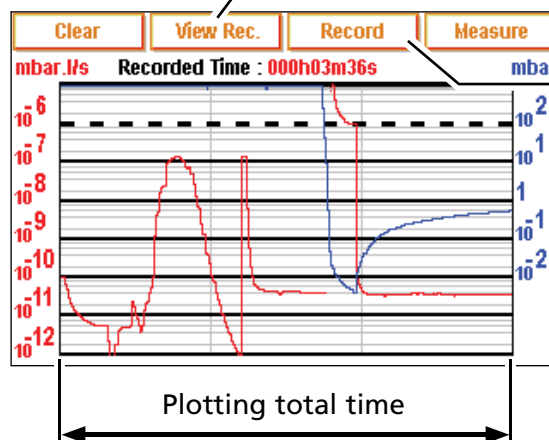

Deletion of the plottings recordings.

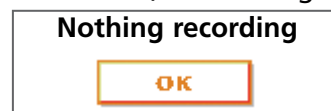

- If any plotting has been done, the message below appears:



Graphic display

Zoom ■ Zoom is only possible on a recorded plotting.

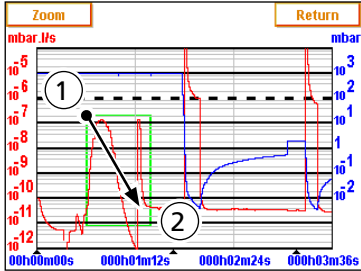
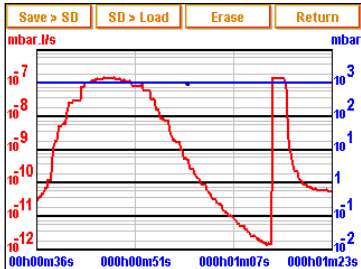
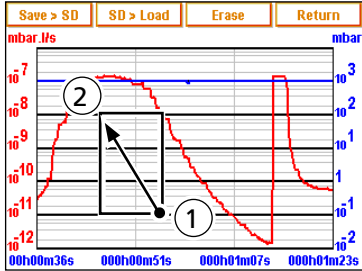

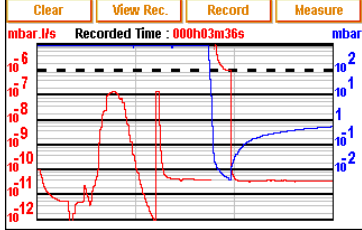
Zoom on	Zoom off
<p>Define the zone to enlarge (point 1 then point 2) :</p>  <p>Zoom</p>  <p>Several successive zooms are possible (except in a same range).</p> <ul style="list-style-type: none"> Adjust if necessary the zone to enlarge by pulling the corners or sides of the zone with your finger. 	<p>Press twice on the screen as indicated below:</p>    <p>Come back to the previous screen if several zooms have been done, repeat the operation until basic graph come back.</p>

Graphic display

Measure ■ Exact measure of one point only possible on a recorded plotting.

1 - Select the point

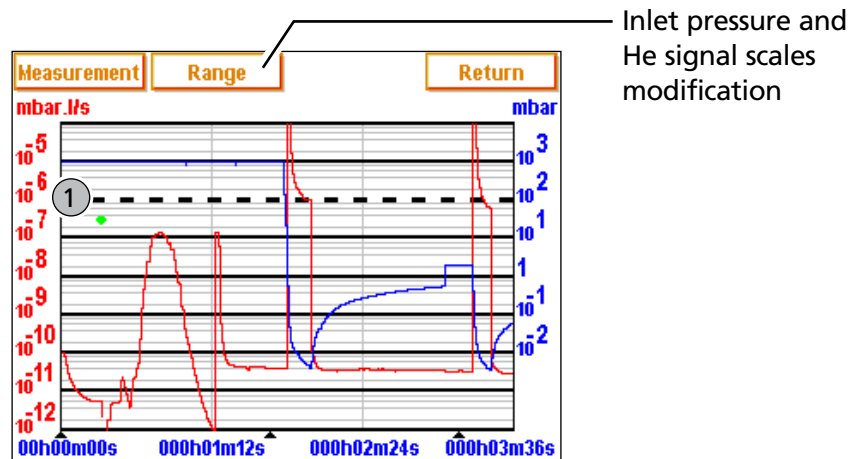

2 - Measurement

3 - Exact display of the selected point value

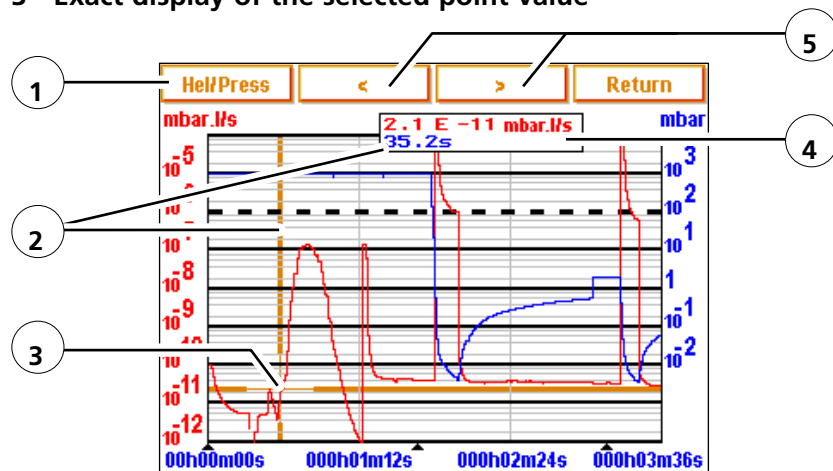

1	Inlet pressure or He signal display selection
2	Measure moment regard to recording beginning
3	Mark indicating the measured point
4	Tracer gas signal value (in red) or inlet pressure (in blue) display
5	Navigation between next/previous recorded points



• To have the exact values of all the recoverable measures under any spreadsheets, save the recorded plotting in .txt file.

Graphic display

Plotting saving

This function allows to save on a SD card the last recorded plotting done for a future reading/analyse on PC.

Saving is not automatic.



It is possible to save a screen copy (.bmp) of the recorded graph or to generate a file (.txt) including the measures done. The .txt file is compatible for any spreadsheets (ex. Excel Microsoft® Office™): the separation by default is "tab".

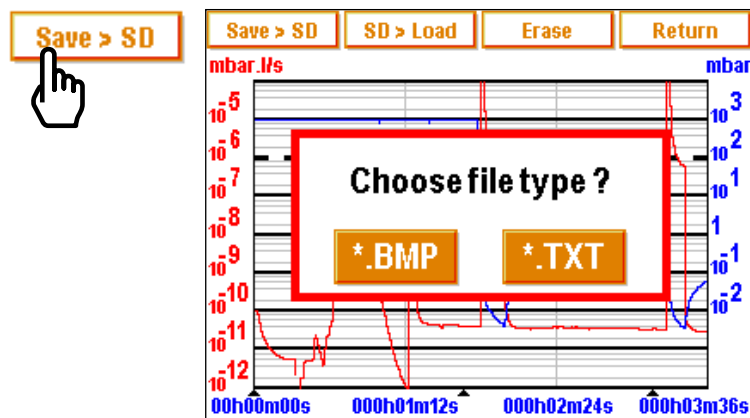

- The .bmp and .txt files saved include only plotting points displayed on the screen:
 - to have all points, it is essential to be on the original plotting (any zoom).
 - if a zoom has been done before the saving, this one will apply only to the points of the selected zone.
- If the saved plotting is constituted by several successive recordings:
 - The cursor "▲" will indicate each recording changes on .bmp files - "B.P. # xx" will be noted at the end of the last plotting of each recording on .txt files.
- .bmp files can be displayed on the control panel screen in the .txt files.
- .txt files can be opened only from a PC.

SD card C 406

Settings

Purpose

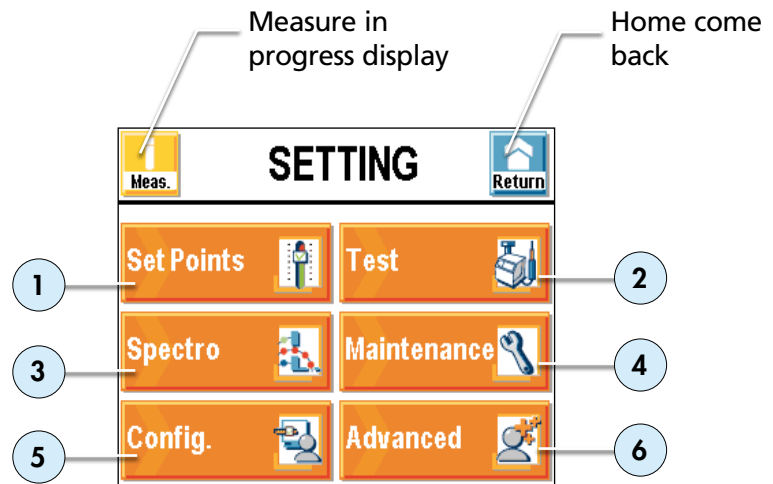











1	Set points setting: reject set point, audio level, digital voice, He max.	C 401
2	Method and test mode selection. Inlet vent management. Correction value.	C 402
3	Tracer gas selection Calibrated leak setting.	C 403
4	Maintenance planning.	C 404
5	Detector configuration for the user: language, unit, password, function keys, applicative windows.	C 405
6	Advanced functions * kept for specific detector uses. It is necessary to read the user's manual. *advanced setting required a good leak detection knowledge: cell setting, pressure gauge, etc.	C 406



- "Setting" menu is also accesible from any window by pressing simultaneously the leys and .

Settings

Legend

	Deactivated function (OFF) A function can be deactivated without modifying the associated setting.
	Activated function (ON).
	Authorized access without password.
	Locked access : access with password
	Orange key : customizable key or parameters access by tactile press on this key
	White key: key not customizable, for information.
	"Ghost" key: key not accessible (option not available or access only authorized to service centers).
	Measure information key: leak value measured display by tactile press ( C 200).
	Function key: access to function A by tactile press or press on the opposite key 

Value adjustment from the control panel

Reject Point : 1.0×10^{-07} mbar.l/s

- + x10 Return

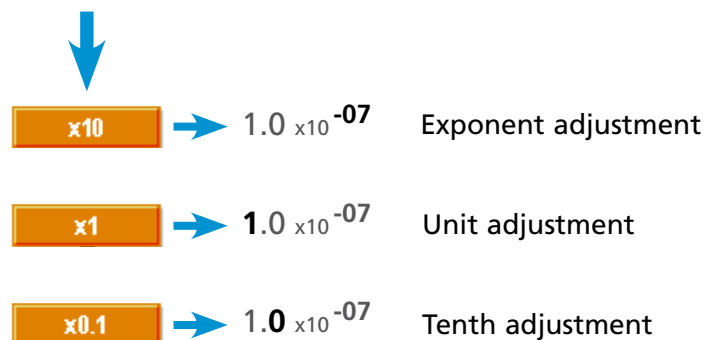

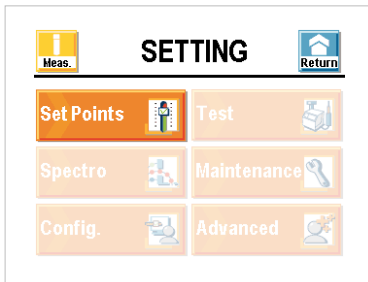

Set points Menu

Purpose Adjustment of the next set points:

- He reject set point (hard vacuum and sniffing)
- audio alarm
- digital voice
- He max.

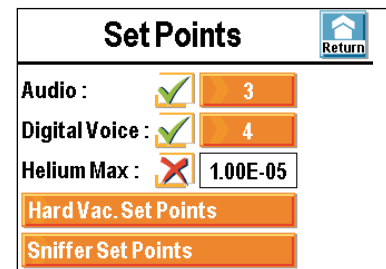

Audio alarm and digital voice set points

Digital voice informs the operator about the detector state or the actions to do.

The audio alarm informs the operator that the reject set point was crossed. The level varies from 0 to 8 (0 to 90 dB).



- Quick access to setting from the control panel:



- Stop simultaneously the audio alarm and the digital voice with the key **Mute**.

Set points Menu

He max. If the signal quickly increases above He max. set point, the cycle is automatically ended and the leak detector returns to stand-by mode.

On this way, the leak detector is protected from gross contamination by gross leaks.

We recommend that the He max. be set a maximum of 4 decades above the set point.

Prevents the detector from being polluted by helium in hard vacuum test mode.

In case of a high background due to pollution, a simple way to purge the helium from inside the detector is to start a cycle without a blank off on the inlet. The detector stays at atmospheric pressure and creates an internal venting that "pushes" helium outside. Just do that 30 s, 2 or 3 times max, and the level will decrease to around 10^{-8} or 10^{-9} mbar.l/s. To decrease the level further, just let the detector run with the inlet blanked off and in test.



- *Very useful function if the part or installation to be tested contains a lot of helium.*

Set Points

HardVac. Set Points Return

Reject Point : 1.00E-07

Sniffer Set Points Return

Reject Point : 1.00E-04

Probe Clogged : 1.00E-06

2 adjustable set points:

- reject set point in hard vacuum,
- reject set point in sniffing.

Define the acceptance threshold of the good/bad parts:

- leak value measured \leq reject set point \Rightarrow part accepted
- leak value measured $>$ reject set point \Rightarrow part rejected.



- *Fast access to setting from the control panel:*

Reject Point

➔

Reject Point : 1.0 $\times 10^{-07}$ mbar.l/s

-
+
 $\times 10$
Return

Set points Menu

Probe clogged

Sniffer Set Points		
Reject Point :	1.00E-04	
Probe Clogged :	1.00E-06	

The purpose of this threshold is to check that the sniffer probe is operational.

When the helium signal is lower than the set "probe clogged" reject point, an information will be communicated to the operator to check the probe.

Sniffer probe maintenance  **G 400**



- *Block the sniffer probe end from time to time with a finger to check that the helium signal goes down. If not, the probe may be clogged.*
 - *Do not block the end a long time: if the measured signal decreases too much, there is risk of taking out of the sniffing test.*
-

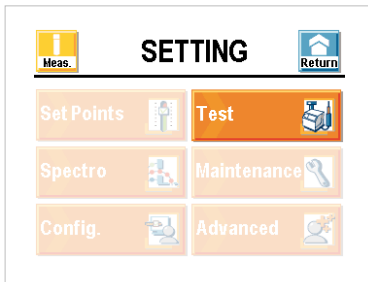

Test Menu

Purpose Adjustment of the next parameters:

- method and test mode
- correction factor
- cycle end
- air inlet

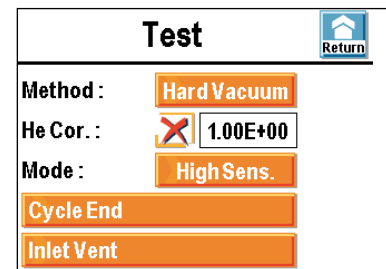

Test methods 2 test methods proposed:

- hard vacuum test
- sniffing test



Hard vacuum test

Make sure that the tested parts can withstand the pressure difference due to the hard vacuum test.





- Quick access to the method choice from the control panel:



Correction factor

The correction factor allows correction of the measured signal by the leak detector when it is in parallel with a pump.

Procedure

- Activate the correction factor function:  or He Cor.: 
- Set the correction factor to apply.

Digital and bargraph display

Only the digital display is corrected by the correction factor.
The correction factor does not apply to the bargraph display.

Test Menu



- Use the correction factor to work in a unit other one than those proposed (See board G 700 for the factor to be applied) or with an installation having its own pumping.
- According to the He concentration level in the gas used for the leak detection, the displayed signal changes.
- Example: signal displayed with a calibrated leak of 1×10^{-7} mbar.l/s (with 100 % He) connected to the detector inlet

% He in the used gas	100 %	50 %	10 %	1 %
Displayed signal on the leak detector without COR	1×10^{-7} mbar.l/s	5×10^{-8} mbar.l/s	1×10^{-8} mbar.l/s	1×10^{-9} mbar.l/s
COR value	1	2	10	100
Displayed signal on the leak detector with COR	1×10^{-7} mbar.l/s			

- Leak detector calibration with a pumping group E 411.

Test mode

A hard vacuum test can be performed as soon as one of the test modes is reached

The leak detector will automatically switch to the selected mode as soon as the inlet pressure has crossed the threshold.

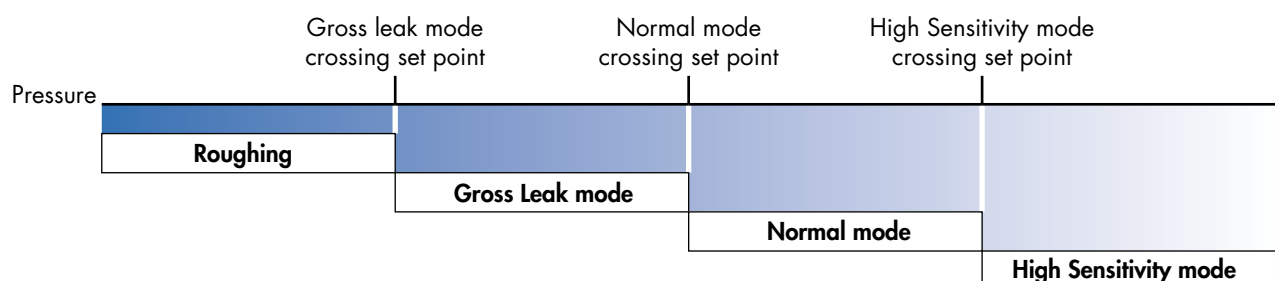

- By default, the leak detector is configured to work in vacuum test, in the most sensitive test mode: this configuration meet the majority of the operators needs.

Test Menu

Cycle end function This function allows an automatic control of the roughing time and measurement time in hard vacuum test.

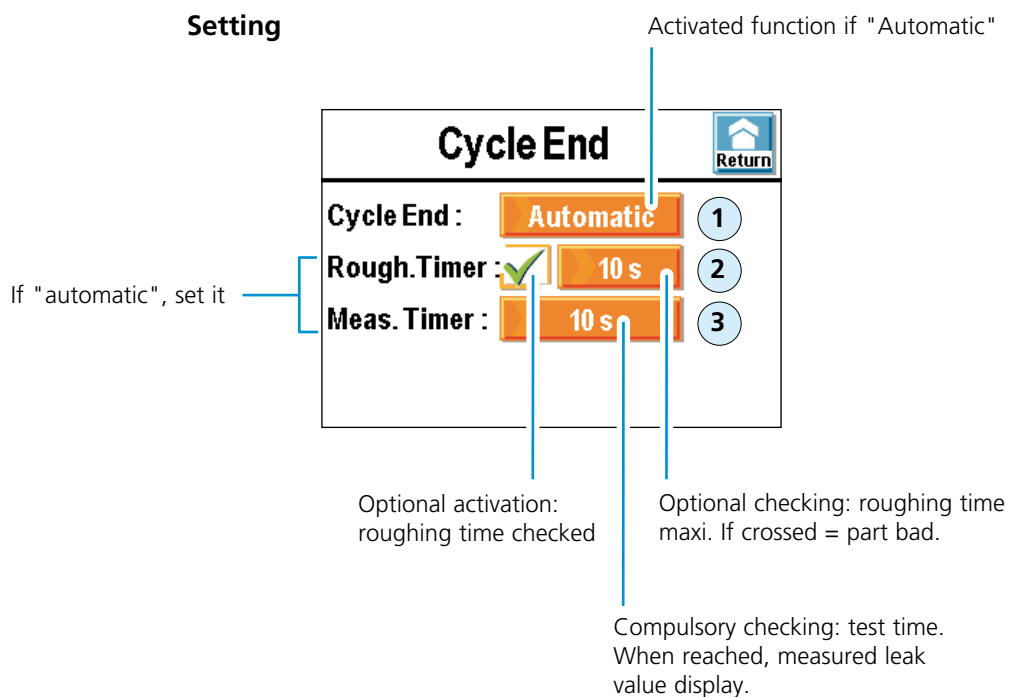

Example ① = Auto ; ② = off ; ③ = 10 sec

- T = 0.....: Cycle start, roughing.
- T = x s: Test pressure reached, measure time counter start (x < 10 s, otherwise part bad).
- T = x + 10 sec.....: Test stop, stand-by mode, inlet vent if automatic



• Function to use to automate small production or realize repetitive operations with different detectors.

Test Menu

Air inlet This function allows an automatic air inlet at the end of a test in hard vacuum test.

This function allows to put back to atmospheric pressure the detector inlet and so the part or volume connected.

This function is secure: a confirmation request displays each time that the operator requests an air inlet.

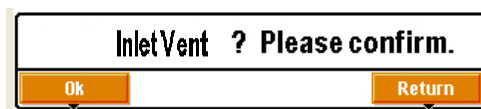

Setting

If "automatic", set it

Inlet Vent Return

Inlet Vent : Operator

Delay : 0 s

Open Timer :
X 9 s

Activated function if "Automatic".

Time between the test stop and the valve opening.

Optional automatic closing activation.

Optional automatic closing function
Time between the valve opening and its automatic closing after.

Inlet vent is automatically done when the operator press START
STAND-BY to stop the test if "Automatic" is selected.

If "Operator" is selected, it is necessary to press the dedicated function key to put back the inlet detector to atmosphere.

Inlet vent manual activation:

From thumb (if parameted) or



From standard window



Test Menu

Air inlet (Cdt)



- To block the air inlet valve command, delete **Inlet Vent** function key ( C 405). The icon  will stay in standard screen as indicator but the manual activation by operator will be deactivated.

CAUTION

This function can be harmful when the detector is connected to an ultra vacuum or semiconductor or thin film chamber! It is important to not do an inlet vent.

In this case, select "Operator", or / and remove the dedicated function key.

The operator will not have the possibility to do an inlet vent, except with this menu (which can be locked with password  C 405).



- Connect an air inlet vent (or nitrogen) at the inlet vent allows to decrease the He pollution or water pollution of the detector.
- The automatic closing after a defined time allows to limit the dry air or nitrogen consummation if this one is connected.
- Always allocate a function key to the inlet vent function to active it manually.

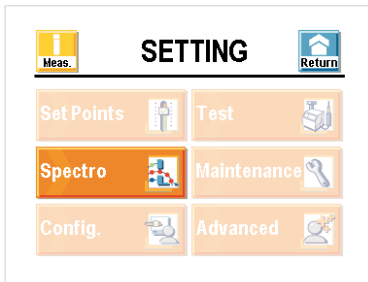

Spectro Menu

Purpose

- Tracer gas selection
- Filament management (switching on/selection)
- Calibrated leak setting

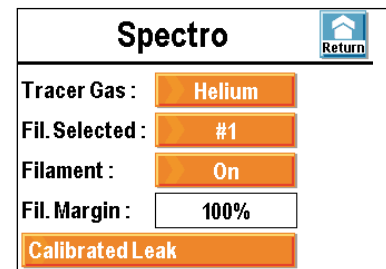

Tracer gas

The tracer gas is the searched gas during a test.
3 gas are proposed: Helium 4, Helium 3 and Hydrogen.

Hydrogen background

Background is much higher in hydrogen.
Typical background values, in cycle, detector on itself:

- at start \pm low range 10^{-5} mbar l/s.
- after 2 or 3 hours \pm low range 10^{-6} mbar l/s.

Test with hydrogen

The 3 masses function purpose, used with hydrogen, is the leak research only and not the continuous analysis of the hydrogen concentration of a gas.

The leak detector is not adapted for a hydrogen concentration continuous analysis. The leak detector use in such conditions, as well as the hydrogen concentration of the gas used, are under the supervision of the user.

Calibration

The leak detector should be calibrated with a calibrated leak of the tracer gas used.

Fil. Margin

It is the global performance indicator of the analyzer cell sensitivity.
Factory departure : Fil. Margin = 100 %

Normal wear on some cell components will reduce this value in the time, without deteriorate the detector measurement accuracy.

Spectro Menu

Calibrated leak

It is necessary to set the calibrated leak used for the autocalibration: use the information indicated on the calibrated leak label or its calibration certificate.

In case of leak change, it is necessary to update these parameters.

- According to the internal or external location selected and tracer gas selected, the parameters displayed correspond to the parameters of the correspondent leak memorized.
- location = internal → the autocalibration will be done with the internal calibrated leak of the leak detector (He leak only).
- location = external → the autocalibration will be done with an external calibrated leak (leak He, ³He or Hy).
- The parameter "Calibration valve" allows to open/close the calibration for a manual calibration for example : this type of calibration is kept to experts. Do not forget to close it back this valve after operation.
- When a parameters saving is realized ( C 406), all data of all calibrated leaks set (1 internal and 3 external) are saved.

Calibrated Leak		Return
Location :	Internal	↑ ↓
Unit :	mbar.l/s	
Leak Value :	1.50E-07	
Carrier Gas :	Helium	
Calib. Valve :	Close	

Calibrated Leak		Return
Loss Per Year (%) :	6	↑ ↓
Ref. T° (°C) :	20	
T° Coeff. (%/°C) :	3.0	
Year :	01/2009	

More informations about the calibrated leaks  E 412.

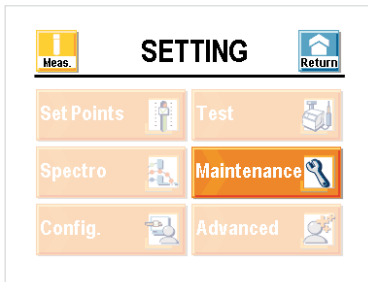

Maintenance Menu

Purpose

Setting of the maintenance follow-up counters:

- primary pump maintenance
- secondary pump maintenance filaments life time
- cycles counter (hard vacuum test)
- general detector counter (under voltage, standby or test).

A message is automatically sent to the operator when the set time is reached to perform a maintenance.

Detector maintenance D and E.

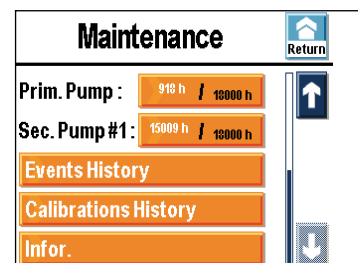
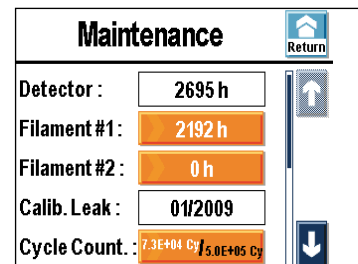

Filament 1-2

Indicates the switching on hours number of the dedicated filament. At each filament exchange, do a counter reset.

Cycles counter

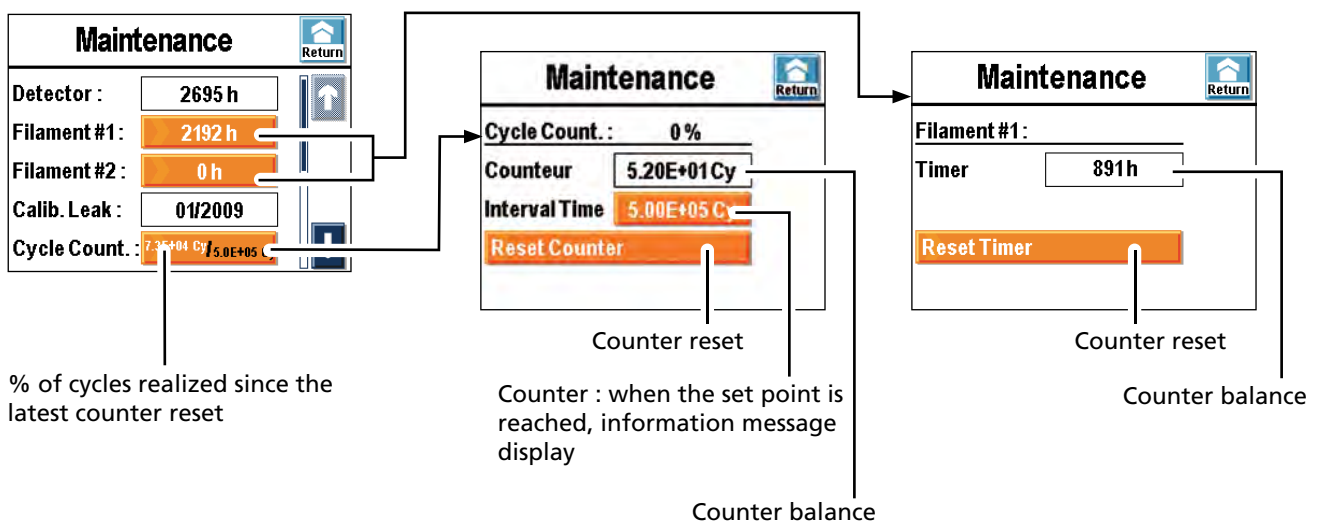

- Do not forget to do a counter reset after having done the maintenance operation.
- According to your need, you can set another value and so better adapt the maintenance to your application.

Maintenance Menu

Primary pump
Secondary pump

	ASM 380	ASM 310
Primary pump	ACP 40	MD1
Secondary pump #1	ATH 184 HLD	AMH 020 HLD

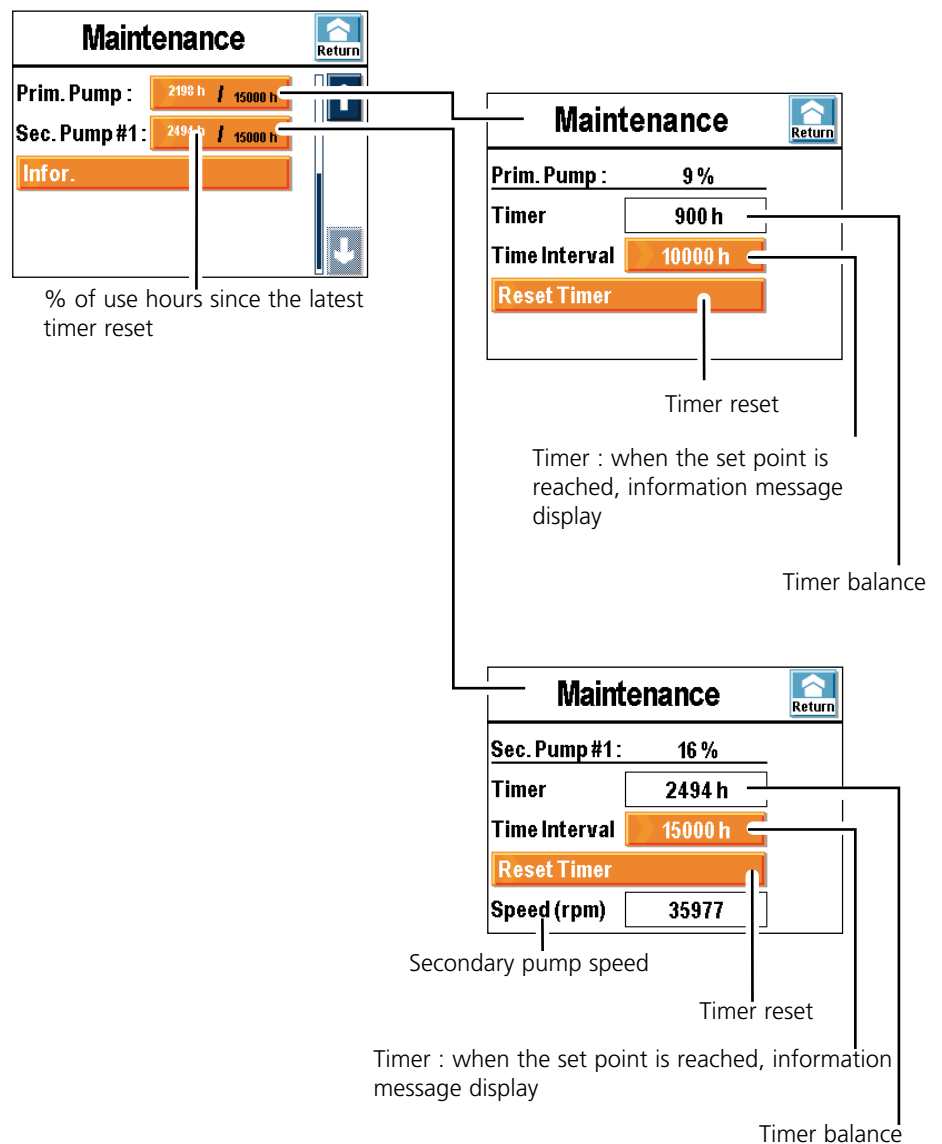

- Do not forget to do a timer reset after having done the maintenance operation.
- With the secondary pump #1 timer, you can follow, for example, the ball bearings maintenance.

Maintenance Menu

Events history

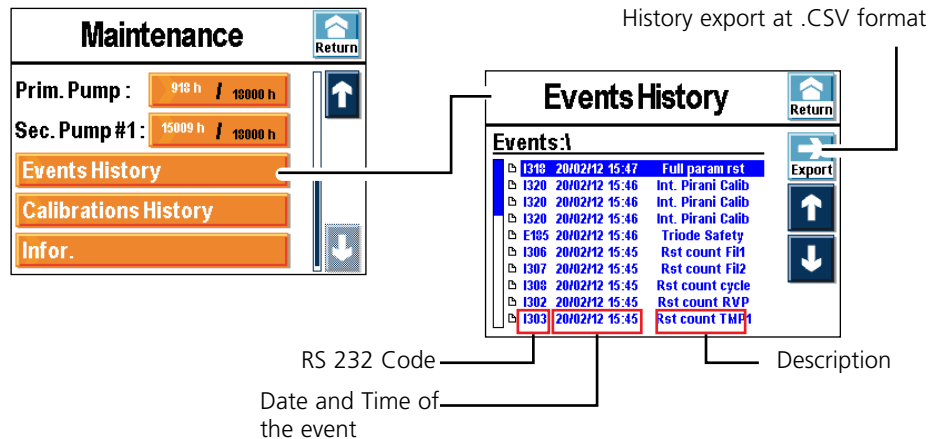

- Event
- = Error (Exxx)
 - = Warning (Wxxx)
 - = Event (Ixxx)
- D 100

Events history records the last 30 events appeared. Beyond 30, the oldest recorded event will be replaced by the last one appeared and so on.

Events list

Code	Event	Description
I300	Air inlet	Air inlet
I301	Stp Cy He>Hemax	Automatic cycle stop if pollution (He signal measured > He max)
I302	Rst count RVP	Primary pump counter reset
I303	Rst count TMP1	High vacuum pump 1 counter reset
I304	Rst count TMP2	High vacuum pump 2 counter reset
I305	Rst count TMP3	High vacuum pump 3 counter reset
I306	Rst count Fil1	Reset filament 1 counter
I307	Rst count Fil2	Reset filament 2 counter
I308	Rst count cycle	Reset cycles counter
I309	Ie increase	Automatic Ie increase to 1,5 mA for He/3He or 0,6 mA for Hy
I310	Autocal restart	Automatic autocalibration restart
I313	Date/Time updat	Date or time change
I318	Full param rst	Complete detector parameters reset
I319	Fil change	Filament change (manually or automatically with firmware)
I320	Calib. Pirani int	Automatic internal Pirani gauge calibration
I321	Storage delay	Storage delay : it is activated if the leak detector doesn't start since 15 days (minimum).

Maintenance Menu

Calibrations history

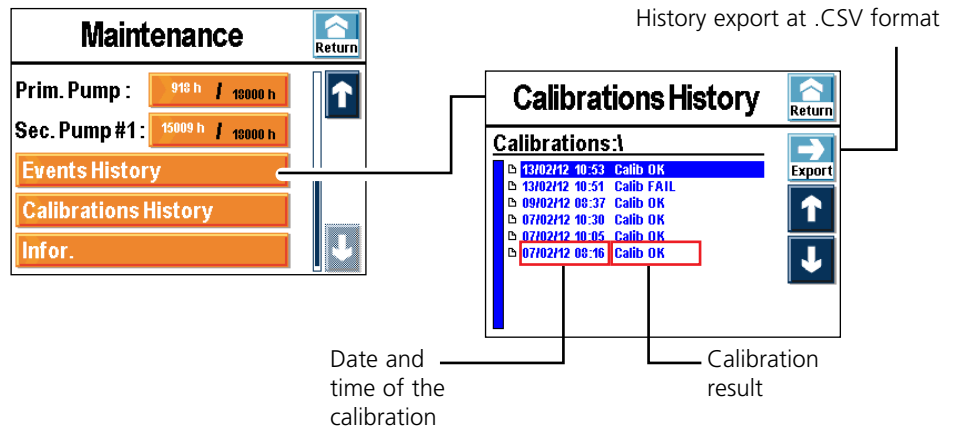

Calibrations history records the last 20 calibrations realized. Beyond 20, the oldest recorded calibration will be replaced by the last one realized and so on.

Infos

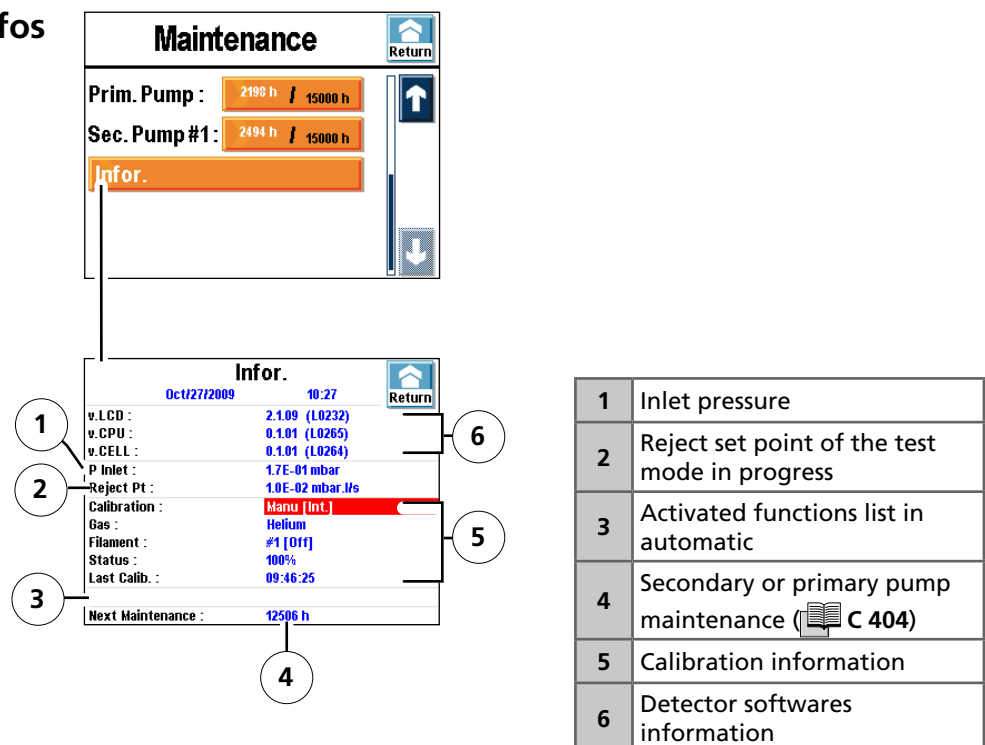

- Quick access to informations from control panel:



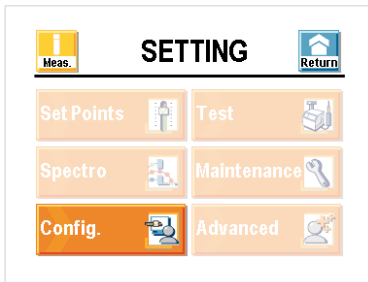

Configuration Menu

Purpose

Setting of the leak detector use parameters:

- hour / date / unit / language,
- function keys (C 200),
- applicative windows,
- screen parameters,
- password management,
- user levels management.

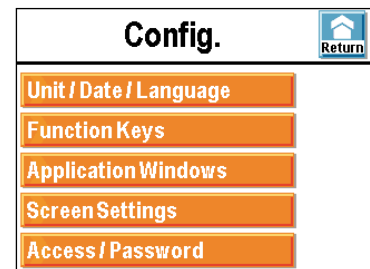

Hour / Date / Unit / Language

The update of these parameters is automatically requested during the first leak detector starting up by the operator: the operator can modify them at any time afterward.

The set points set are not automatically converted in the new unit in case of unit change: the operator must to update them.

The hour is not automatically updated at the passage of the summer time to the winter time and conversely: the operator must to update them

Function keys

The function keys allow to activate/stop a function or to set set points from the different applicative windows.

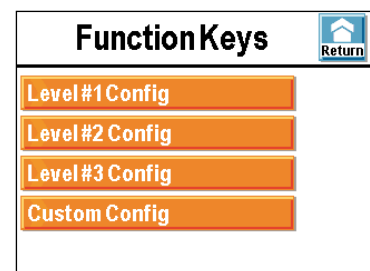

3 configurations are predefined.

The operator can also define its own function keys configuration.

Configuration Menu

Predifined configurations

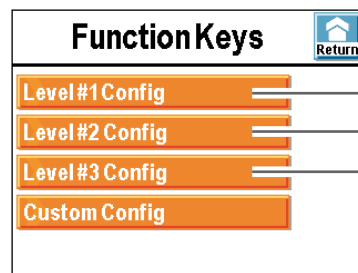

Examples (*)

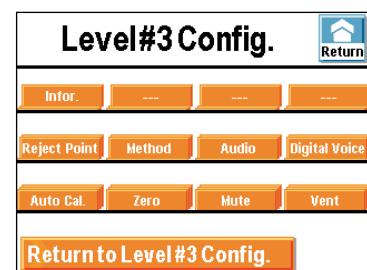
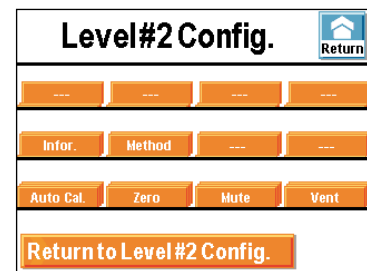
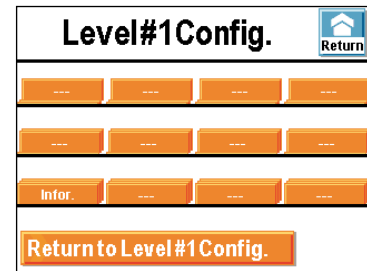

(*) Predifined configurations change according to leak detector model.

Customized configuration

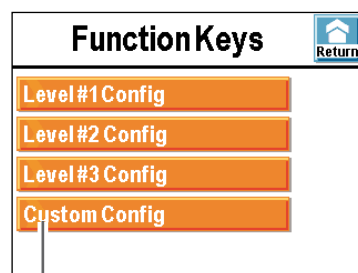

Access to customized configuration.

Each function key can be allocated to a chosen function by the operator: see the example next page.

Thanks to the function keys, it is possible to give to the operator a limited functions access and to protect by password the other notauthorized functions of the "Setting" menu.

Configuration Menu

Example:

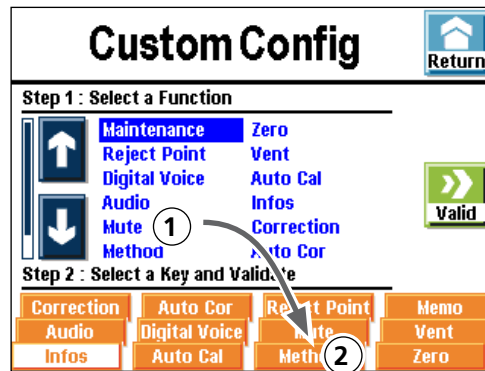

Allocate the "Mute" function ① to the function key ②.

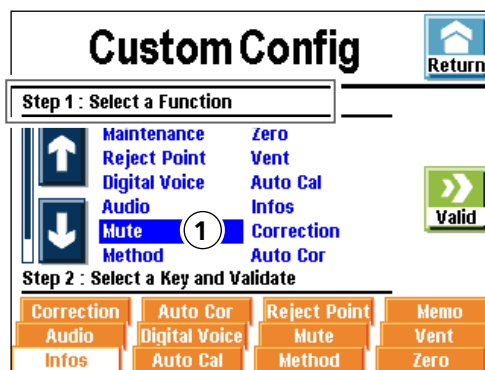

Select the "Mute" function ① with the arrows ↑ and ↓.

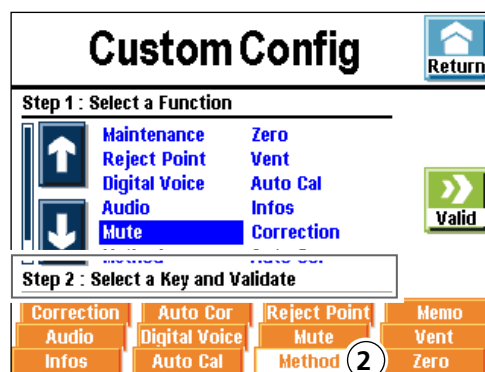

Select the function key ② by successive presses (key selected if white bottom).

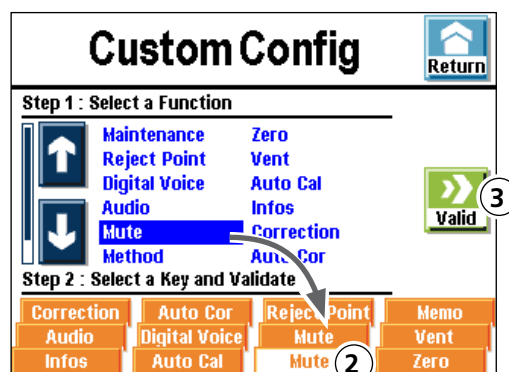

Valid the configuration ③ : the function key ② is now allocated to the "Mute" function.

Configuration Menu

Applicative windows By successive presses on the key , the different applicative windows available appear.

The operator can hide one or several windows or switch around the scrolling order of these.

The standard applicative window is always available:

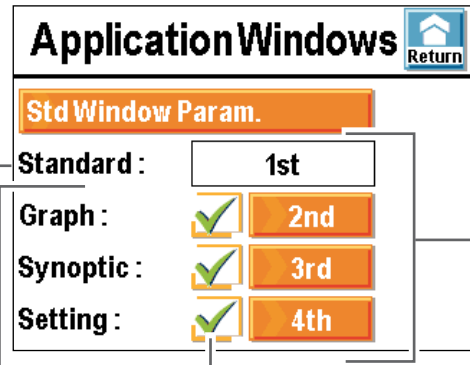

Standard applicative window always available

Windows proposed

Order of the displayed windows with the touch 

Selection of the displayed windows.

The screenshot shows a menu titled 'Application Windows' with a 'Return' button. Below it is a sub-menu 'Std Window Param.' with four rows: 'Standard : 1st', 'Graph : [checked] 2nd', 'Synoptic : [checked] 3rd', and 'Setting : [checked] 4th'. A home key icon is shown to the right of the menu.

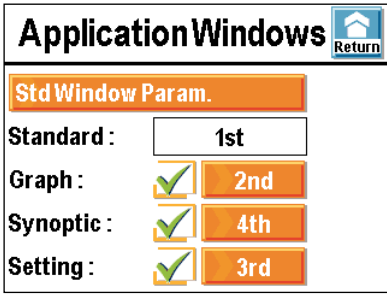

The window order can be modified: tactile press on the order number and use the keys **+** and **-**, then validation.

The screenshot shows the same 'Application Windows' menu, but the 'Graph' row now has '2nd' and '4th' buttons, and the 'Synoptic' row has '4th' and '3rd' buttons. The 'Standard' row remains '1st'.

When a window is no more selected ( **off**) or if its order has been changed, the order is automatically updated.

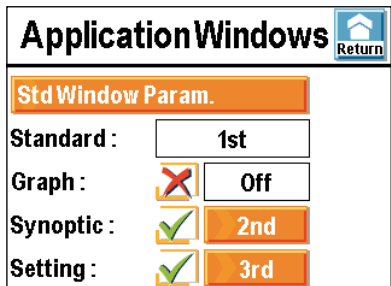

The screenshot shows the 'Application Windows' menu where the 'Graph' row now has a red 'X' icon and the word 'Off' instead of an order number. The other rows remain the same.

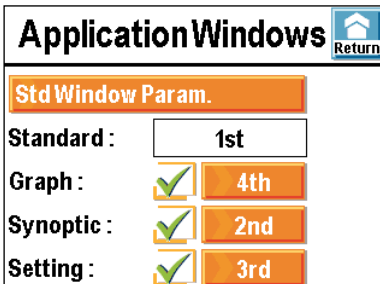

When a window is again selected, it takes place automatically at the last position.

The screenshot shows the 'Application Windows' menu where the 'Graph' row now has '4th' and '2nd' buttons, and the 'Synoptic' row has '2nd' and '3rd' buttons. The 'Standard' row remains '1st'.

Configuration Menu

Standard windows parameters

- Max decade of the bargraph.
- Mini decade of the bargraph.
- Display/masking of the inlet pressure on the standard display.
- He signal display in stand-by mode.
- Display/masking of the cell pressure on the standard display.

Screen settings

Control panel parameters (= factory leaving configuration (C 500)).

Nota : the screensaver corresponds to the retro-lighting extinction (black screen). The detector seems switched off but it is not the case! A single press on the touch-sensitive screen reactivates the display. By default, the automatic panel off is not activated.

Access password

User levels



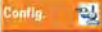

3 user levels allow restricting display and access to settings and functions.

Configuration Menu

To change access level:

- press  an enter password.
-  → **User Level** → Change the level.



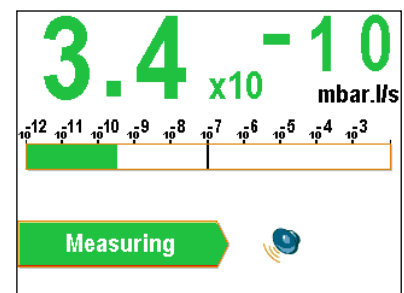
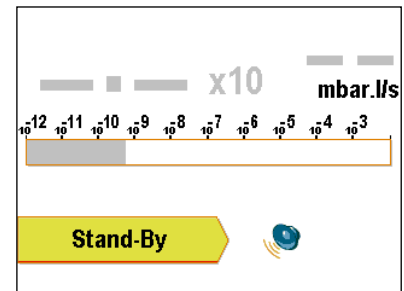

-  key invalid: any setting possible
-  picto invalid
- Function keys hidden
- Inlet pressure and cell pressure hidden
-  key invalid: test start only by RS
- Measured leak value and reject set point displayed only in test
- Access to "Setting" menu by pressing on  for a long time.

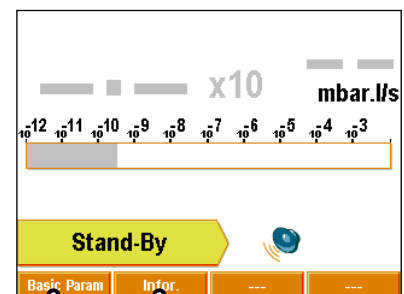

-  key invalid but access with password: setting possible
- 2 function keys available: « Info » and « Basic param. »
- Cell pressure hidden
- Function keys hidden





Basic Param		
Hard Vac. Set Points :	1.00E-07 mbar.l/s	
Sniffer Set Points :	1.00E-06 mbar.l/s	
Method :	Hard Vacuum	
Mode :	Normal	
Gas :	Helium	
P Inlet :	3.2E+04 mbar	

Infor.		
Oct127/2009 10:27		
v.LCD :	2.1.09 (L0232)	
v.CPU :	0.1.01 (L0265)	
v.CELL :	0.1.01 (L0264)	
P Inlet :	1.7E-01 mbar	
Reject Pt :	1.0E-02 mbar.l/s	
Calibration :	Manu [Int.]	
Gas :	Helium	
Filament :	#1 [Off]	
Status :	100%	
Last Calib. :	09:46:25	
Next Maintenance :	12506 h	

Configuration Menu



- Inlet pressure and cell pressure hidden
-  key valid
- Measured leak value and reject set point displayed only in test.
- Access to "Setting" menu by pressing on  for a long time.

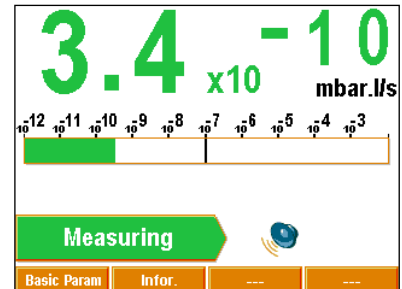

- Any restriction

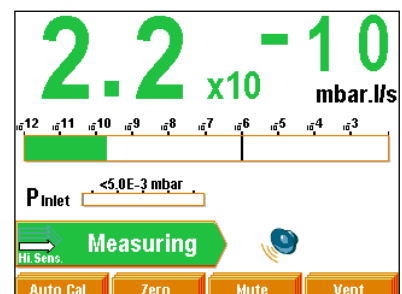
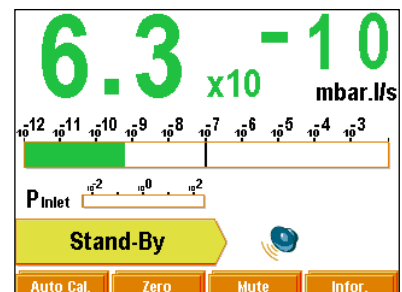

Configuration Menu

"Setting" menu locking The operator can lock the access to one or several setting menus. To access to a locked menu, the password will be ask to the operator.

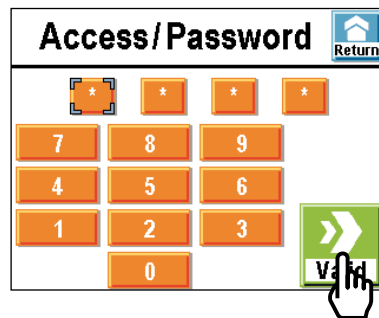

- Enter the password (5555 by default) and validate.
- Lock a menu by tactile press on the opened padlock.
- To unlock a menu, tactile press on its closed padlock.

■ Example : Locking of Set Points, Spectro and Advanced menus.

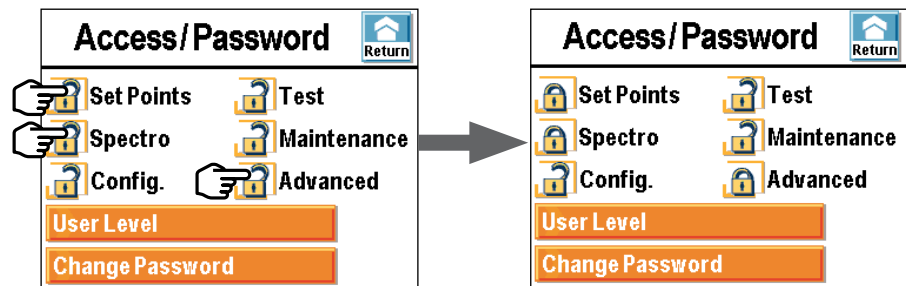

Configuration Menu

In the "Setting" window, the locked menus are indicated with a closed padlock.

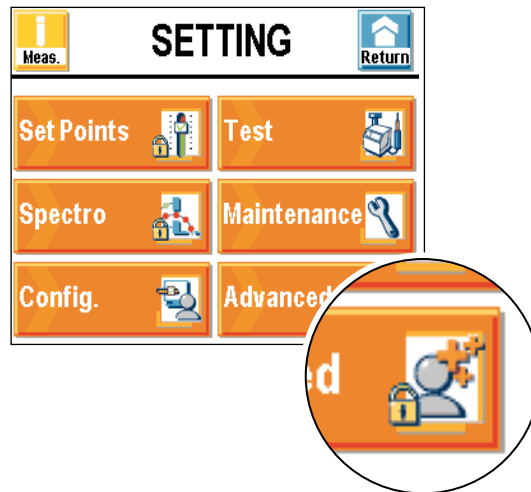

Change password



- Enter the password (5555 by default) and validate.
- Select "Change password": enter the new password and validate.

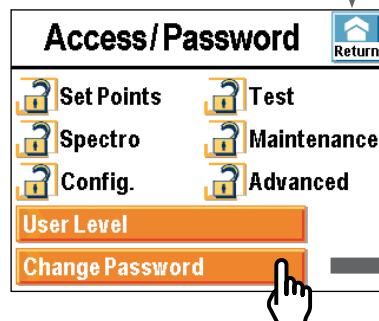

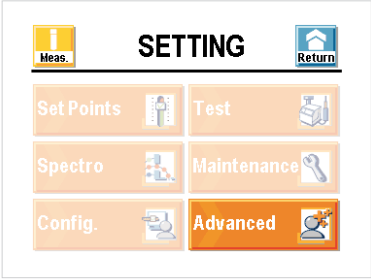

Advanced Menu

Advanced menu is kept to leak detection experts and/or to a particular product configuration.

Purpose Parameters setting connected to:

- advanced functions,
- inputs/outputs,
- SD card (data saving).

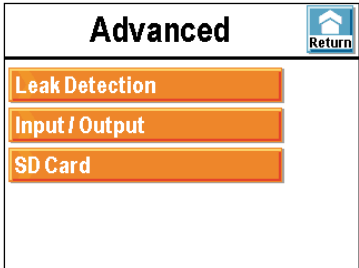

Leak detection menu Setting of the next parameters:

- start-up time delay,
- Memo function,
- background suppression,
- Calibration.

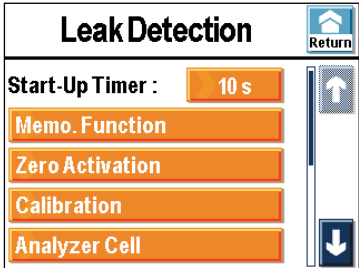

Setting of the next components:

- analyzer cell,
- internal gauge.

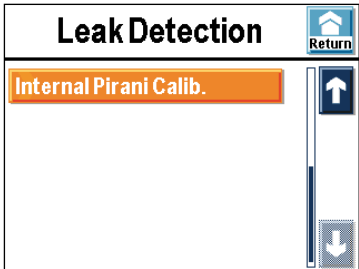

Leak detection: Start-up time delay

This function prevents the leak detector use during a defined time after its switching on. It forbids a measure while the leak detector is neither thermally stabilized, nor degased.

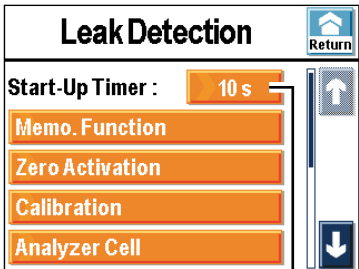

Leak detector locking time

Advanced Menu

Leak detection: Memo function

This function freezes the screen with the last test result: the measured value displays and flashes.

Setting

Function activation.

Time delay period

Display time delay activation:

- On : the measured leak value will flash during the time delay period set.
- Off : the measured leak value will flash until a new test will be started.



• Quick access to setting from the control panel:

Leak detection: Zero activation function

This function allows to help the operator to identify very small He signal variations in the surrounding background or to dilate small measured signal fluctuations on the bargraph display, for example at the pump slowing down.

Activated function if "automatic"

If "auto, to set

Function triggering mode

Function triggering set point

- Manual activation of the Zero function:



- It is advised to use this function when the He background is high and stable.
- This function allows to measure a leak flow 2 ranges below the detector background in progress, as soon as this one is no more in roughing.

Advanced Menu

Leak detection: Calibration It allows to check that the detector is adjusted to detect the selected tracer gas and display a correct leak value.

Generally, to calibrate the leak detector, a calibrated leak is used as reference.

Our leak detectors are equipped with an internal He calibrated leak with reservoir and compensation sensor in temperature.

Setting

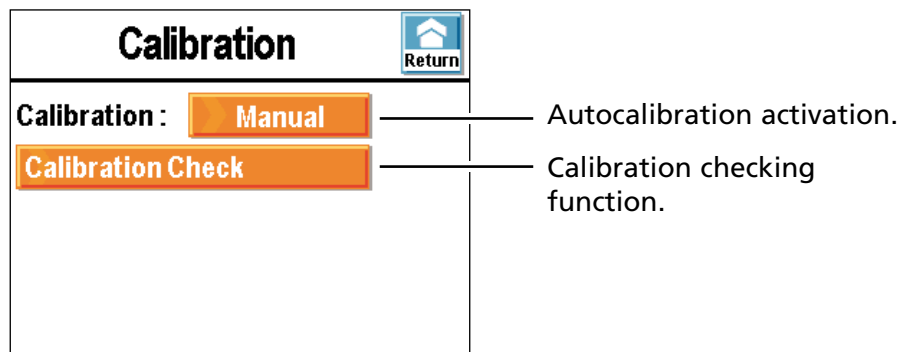

By default, autocalibration is set operator and the internal calibrated leak is selected to allow a quick leak detector autocalibration.

- Calibration = operator
Calibration must be start by the operator (**Auto Cal.** key) at the leak detector switch on.

If calibration is not realized in the next 20 mn after the leak detector switch on, a reminder message displays.

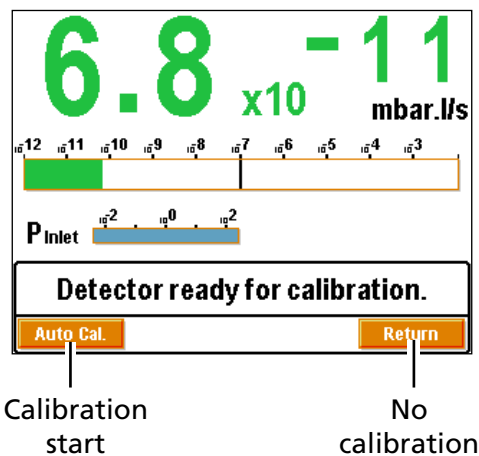

- Calibration = starting
Calibration is automatically start at the leak detector switch on.

Advanced Menu

Other advanced methods It is also possible to do a detector autocalibration with an external calibrated leak  **D 410**.



- *It is advised to perform an autocalibration:*
 - *at the detector switching on in order to make sure that it is in correct conditions use*
 - *to optimize the measure reliability for high sensitivity tests*
 - *in case of doubt about the good leak detector functioning(ability to detect correctly a He leak). At any time, an internal calibration can be launched.*
 - *in case of continuous and intensive use: launch an internal calibration at each team beginning (8 hours of work).*

Calibration checking Autocalibration ON, the function "calibration checking" does a calibration checking according to set parameters.
 The calibration checking is done with the internal calibrated leak (location parameter = internal).
 The calibration checking function allows to the operator to gain time because the calibration checking is faster than the complete calibration.

The leak detector compares the internal calibrated leak delivered signal to the calibrated leak parameters memorized:

- If the value is correct, the leak detector calibration is good.
- If the value is out of limits, there is a message which request to start acomplete leak detector calibration.

Calibration Checking
 Return

Checking : Automatic Function activation.

Every : 50 Cy

Every : 10 h Set points launching the calibration checking. The first reached will launch the checking.



- *At any time, the operator can launch a leak detector calibration checking: detector in stand-by mode, press twice on the function key Auto Cal in less than 5 secondes*

Advanced Menu

Leak detection: Analyzer cell

Parameters available in this menu are mainly used for a leak detector manual calibration.

THIS TYPE OF CALIBRATION IS KEPT FOR SERVICE CENTERS.

Filament selection.

Filament switching on.

Parameters for manual calibration.

Filament There are 2 filaments in the analyzer cell. The operator can select the one or the other one.

The filament can be switched off by the operator (OFF): it is not necessary to switch it off in stand-by mode to save it.



- Do not switch off the filament except to do a manual calibration.
- Attention : the manual calibration is kept to leak detection experts.
- The leak detector swings automatically from a filament to the other one if the selected filament in progress of use becomes defective.
- At the leak detector switching on, the detector will start again with the selected filament at the last switching off.

Advanced Menu

Leak detection: Internal Pirani gauge calibration

This function allows to calibrate the detector internal gauge.

Setting ■ "Cycle end" function = operator (📖 C 402).

- Close the detector inlet with a blank-off flange. Be sure that the detector is in hard vacuum test and high sensitivity mode(📖 C 404).

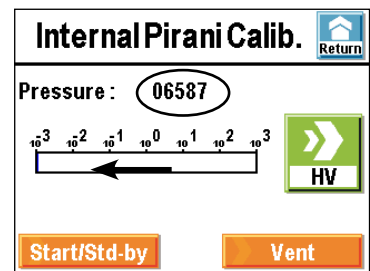

- Limit pressure adjustment
Make sure that the internal pressure is widely lower than 10^{-3} mbar.

Start a cycle: press **Start/Std-by**
The value "Pressure" decreases:
wait the stabilisation of this value
(around 5 minutes) and press on the key .

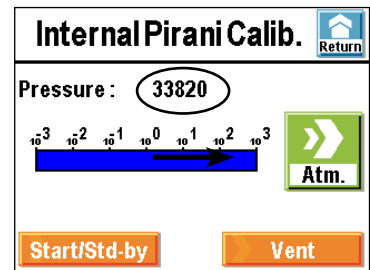

- Stop the cycle: press **Start/Std-by**
Make sure that the detector is at atmospheric pressure.
The value "Pressure" increases:
wait the stabilisation of this value
(around 5 minutes) and press on the key .

Input/Output menu

Setting of the RS 232 serial connection parameters.

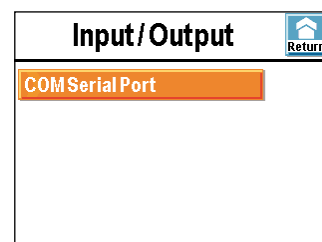

Advanced Menu

Input/Output: COM serial port

Connection:  B 300

Basic/Spreadsheets/ Advanced modes

Refer to the RS 232 specific operating manual delivered with your leak detector.

COMSerialPort	
Mode :	Spreadsheet
Time Period :	1s
Handshake :	None

Printer mode

The Printer interface makes it possible to connect the leak detector to a printer.

Connector description

Pin	Function
1	RS 485 V-
2	Rx
3	Tx
4	RS 485 V+
5	Ground
6	120 Ω class to connect to RS 485 V-
7	Not used
8	Not used
9	+ 5 V ; 500 mA

Communication protocol	
Mode	Asynchronous
Bauds	9600
Bits	8
Parity	None
Stop bit	1
Parity control	None

Communication mode description

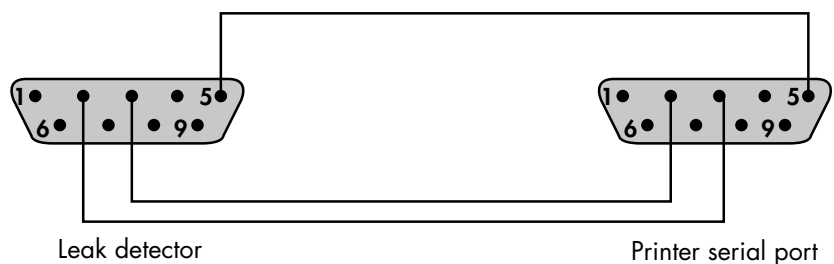

The tickets of communication are printed.

Connection to the printer



Advanced Menu

Tickets available

Ticket	Example	Printing
Internal calibration with an internal leak/ external leak	A	Automatic printing after an internal calibration with an internal/ external leak: refer to  E 410
Adjustment checking with an internal leak	B	Automatic printing after an adjustment checking with an internal leak: refer to  C 406
Test/Cycle	C	Automatic printing at the end of the test. <i>The Memo function must be activated</i>  C 406

Internal calibration with an internal leak/external leak

A

```

DATE:Jan/08/2007 TIME:01:34:41
ASM310 CALIBRATION gas: He
unit: mbar.l/sec

CALIBRATED LEAK PARAMETERS:
location: internal/external
value: 1.5E-07
unit: mbar.l/sec
calibration year: 2005
loss per year (%): 06.00
calibration temperature (C): 20
temperature coefficient (%/C): 3.00
TARGET PARAMETERS:
current internal temperature (C): 32
target value: 1.9E-07
ELECTRONIC ZERO:
done: yes
PEAK ADJUSTMENT :
dac_ref.=1162
vacc_ref.=141.8
dac_peak.=1179
vacc_peak.=141.8 yes
SIGNAL RECORDS (no calibrated):
global: 3.5E-07
background: 1.1E-10
CALIBRATION INFORMATIONS:
total time(sec): 75
result: COMPLETED

CURRENT ASM310 CALIBRATION:
DATE:Jan/08/2007 TIME:01:34:41
Fil:1 Ie=0.6 Vac=140.6
Coef_cal:00.54
    
```

Advanced Menu

Calibration checking with an internal leak

B

```
CALIBRATION INFORMATIONS:
DATE|Jan/08/2007 TIME|01:37:20
current internal temperature(C)| 32
current coef.sens| 00.54
global rate| 1.91E-07
background rate| 6.39E-11
calibrated leak-rate| 1.191E-07
target value| 1.89E-07
percent allowance (+/-)| 15
RESULT(%): 1
```

Test ticket

C

```
DATE:Jan/08/2007
CASE PRESSURE LEAKRATE
00:28:26 start 3.8E+01 3.4E-11
00:28:55 GL 1.2E-02 -----
00:29:40 NR 6.3E-05 -----
00:29:45 stop 5.8E-05 1.1E-05
NR
```

Leak value

```
DATE:Jan/08/2007
CASE PRESSURE LEAKRATE
01:02:31 start 6.5E+01 4.8E-11
01:02:32 GL 4.6E+01 -----
01:02:33 NR 5.9E-02 -----
01:02:36 stop 9.9E-05 1.3E-05
NR FAIL
```

Leak value



Test result if Memo function activated

Memo function C 406

Advanced Menu

SD card menu

The SD card allows:

- to load leak detector parameters,
- to save leak detector parameters,
- to save recorded test sequences,  **C 300**,
- to visualize .bmp files on the applicative window  **C 300**.

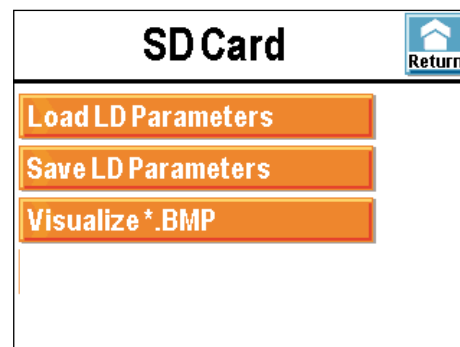

All SD cards in the shop can be used except cards with High Capacity technology, whatever is its capacity. It is necessary to check that the SD card is not locked before its use (message "SD card not detected" displayed).

Load/Save Detec. Param.

The « Load/Save Detec. Param. » functions allow to load/save current leak detector parameters, which means factory configuration for parameters not modified ( **C 500**) and modifications done by the user. You can find below a saving example (leak detector parameters + control panel parameters).



- If you use the leak detector for several applications, do a configurations library (set parameters) appropriate for every application.
- If you want to configure several detectors in a identical way, use the SD card to save of the one and load on the other one.

Leak detector parameters

Don't take commands marked with (*) into account: commands not validated for this product or for manufacturer R&D only use.

Command (RS 232 code)	Read value	Parameters command
Depollution param. (?AA)	100-07D	[=AA100-07D]
Autocal validation (?AC)	E	[=ACE]
?AC1 (?AC1) (*)	221-09	
?AC2 (?AC2) (*)	372-13	
Automatic Autocal (?ACA)	D0000500010	[=ACAD0000500010]
Value extern HV cal. (?AEH)	150-09	[=AEH150-09]
Value extern SN cal. (?AES)	500-08	[=AES500-08]
Analog output1 (?AO1)	1	[=AO11]
?AP (?AP) (*)	300-06E	[=AP300-06E]
Autozero status (?AZ)	D	[=AZD]
Auto cycle param. (?CA)	DE00100010	[=CADE00100010]

Advanced Menu

Command (RS 232 code)	Read value	Parameters command
Fil. sens. coeff. (?CF)	669-03100-02	[=CF669-031] [=CF100-022]
Hours counters val. (?CH)	004860026400000	
Communication param. (?CO)	38N2	
?CP (?CP) (*)	800-02000+00655+02	[=CP800-02000+00655+02]
Current Det. status (?CY)	HV	
Date (?DA)	112508	
Memorized defaults (?ER)	0	
RS flow control used (?FC)	1	[!INU]
Internal calib. leak (?FE)	140-0936200620	[=FE140-0936200620]
Calib. Leak select (?FEP)	E	[=FEPE]
Fil. availability (?FM)	11	
Tracer gas used (?GZ)	4	[=GZ4]
?HT (?HT) (*)	E	[=HTE]
HV external coeff. (?HV)	106-02D	[=HV106-02D]
Emission current (?IE)	059	[=IE059]
Fil1 desired curr. (?IE1)	060	
Fil2 desired curr. (?IE2)	060	
Logic input status (?IN)	00000D	
Command (RS 232 code)	Read value	Parameters command
He signal calibrated (?LE)	211-14R	
?LE1 (?LE1) (*)	320-14	
He signal not cor. (?LE2)	214-14	
Panel locking status (?LO)	D	
Primary pump counter (?MCO)	0026515000	[=MCO15000]
HV pump counter (?MC1)	0026415000	[=MC115000]
Rough pump1 counter (?MC2) (*)	0026400000	[=MC2100000]
Rough pump2 counter (?MC3) (*)	0026400000	[=MC3100000]
Cycle counter (?MCC)	800-02500+03	[=MCCI500+03]
CPU soft version (?MD)	ASM310L0226V0.0r04	
Memo func. status (?ME)	AD0010000+00	[=MEAD0010]
Logic output status (?OU)	00000D	
GL press. threshold (?P1)	150-01	[=P1150-01]
Norm. pr. threshold (?P2)	500-03	[=P2500-03]
HS press. threshold (?P3)	400-04	[=P3400-04]
Inlet pressure (?PE)	760+00	
Cell pressure (?PS)	100-06	
Password (?PW)	5555D	[=PW5555D]
?RDO (?RDO) (*)	02030	
?RD2 (?RD2) (*)	005	[=RD2005]

Advanced Menu

Command (RS 232 code)		Read value	Parameters command
?RD3 (?RD3)	(*)	019013	[=RD3019013]
?RD4 (?RD4)	(*)	000031	[=RD4000031]
?RD6 (?RD6)	(*)	1	[=RD61]
?RD9 (?RD9)	(*)	000	
?RDA (?RDA)	(*)	101597	[=RDA101597]
?RDB (?RDB)	(*)	096419	[=RDB096419]
?RDC (?RDC)	(*)		[=RDC]
?RDE (?RDE)	(*)	000	
?RDF (?RDF)	(*)	000	
?RDG (?RDG)	(*)	000	
Discharge protocol (?AK)		E	[!NK]
Analog output2 (?AO2)		2100-14	[=AO22100-14]
?RDQ (?RDQ)	(*)	000400	[=RDQ000400]
?RDK (?RDK)	(*)	0111D	[=RDK0111D]
?RDT (?RDT)	(*)	1324823874	
Latest test result (?RE)		E	
RS232mode (?RS)		3	[=RS3]
HV signal threshold (?S1H)		100-09	[=S1100-09H]
SN signal threshold (?S1S)		100-06	[=S1100-06S]
Analyzer cell status (?SC)		100	
Sniff.extern coeff (?SN)		100-02D	[=SN100-02D]
Sound status (?SO)		2E	[=SO2E]
Language (?SP)		ANG	[=SPO]
?SR (?SR)	(*)	0yyyyyy	
Detector status (?ST)		56642	
Active filament (?SW)		1	[=SW1]
Command (RS 232 code)		Read value	Parameters command
Digital voices status (?SY)		4D	[=SY4D]
Zero ref. status (?SZ)		000+00	
HV pump infos (?T1)		2	
HV pump more infos (?T1M)		0026400	
Rough1 pump infos (?T2)	(*)	S	
R.1 pump more infos (?T2M)	(*)	0026400	
Rough2 pump infos (?T3)	(*)	S	
R.2 pump more infos (?T3M)	(*)	0026400	
Temperature (?TE)		28S	[=TE28S]
Current hour (?TI)		133646	
Latest shut down time (?TIA)		090247	
Latest autocal time (?TIC)		091844	
Latest start-up time (?TIM)		091549	
HLD status (?TR)		219-1423874760-02	
Measure unit used (?UN)		2	[=UN2]

Advanced Menu

Command (RS 232 code)	Read value	Parameters command
HV pump speed (?V1)	00003D	
Rough1 pimp speed (?V2)	00003D	
?VA2 (?VA) (*)	00024	
T. base spreadsheet (?VE)	000001	[=VE000001]
{?VO}	135	
{?VO1}	138	[=VO1138]
{?VO2}	141	[=VO2141]
{?VT}	A	[=VTA]
{?ZE}	167	
{?ZR}	D	[=ZRD]
{?AC3}	157-10	
{?S1}	100-09	[=S1100-09]
{?S6}	100-10	[=S6100-10]
{?WA}	0	
{?RDO} (*)	000000000	
{?CYT}	4	[=CYT4]
{?RJT} (*)	D	
{?SHE} (*)	335-13	
{?PIC} (*)	00000D100+07100+06	[=PIC00000D100+07100+06]
{?FEM}	4140-091E302006200628	[=FEM4140-091E302006200628]
{?P4} (*)	500-03	[=P4500-03]
{?IV}	D	
{?IP} (*)		
{?IPO} (*)	0000	[=IPO000]
{?IP1} (*)	0000	[=IP1000]
{?IP2} (*)	0000	[=IP2000]
{?IP3} (*)	0000	[=IP3000]
{?OP} (*)		
{?OP0} (*)	0000	[=OP0000]
{?OP1} (*)	0000	[=OP1000]
{?OP2} (*)	0000	[=OP2000]
Command (RS 232 code)	Read value	Parameters command
{?OP3} (*)	0000	[=OP3000]
{?OP4} (*)	0000	[=OP4000]
{?IPG} (*)	AT2573308500584029781	[=IPG0584029781]
EEProm write cycles (?EEP) (*)	000053025121024	
Test method used (?TST)	0	[=TST0]
Inlet Vent Param. (?IVP)	A1E0009	[=IVPA1E0009]
Background suppr. (?ZB)	O_0010500-09	[=ZBO_0010500-09]
First detector run (?P3D) (*)	0	[=P3D0]
{?CRX} (*)		

Advanced Menu

Command (RS 232 code)	Read value	Parameters command
{CES} (*)	001006	
{CET} (*)	0000001	
Checksum detector {CKS} (*)	6CD2	
Elec. Zero 0 to 1023 {ZEL} (*)	0668	[=ZE0668]
Acc Voltage1/10V {AVO} (*)	1355	[=AVO1355]
{RDR} {RDR} (*)	000110	[=RDR000110]
{CPI} {CPI} (*)		
{PPI} {PPI} (*)		
{NPI} {NPI} (*)	049	
Filament defaults {FMD} (*)	00	
Cell soft. version {VSC} (*)	L0227V1.0r02	
Characteriz. Vacc {CCR} (*)	02206	[=CCR2102206]
Characteriz. Vacc {CCR} (*)	01495	[=CCR3101495]
Characteriz. Vacc {CCR} (*)	01134	[=CCR4101134]
Characteriz. Vacc {CCR} (*)	02236	[=CCR2202236]
Characteriz. Vacc {CCR} (*)	01515	[=CCR3201515]
Characteriz. Vacc {CCR} (*)	01146	[=CCR4201146]
Checksum {CHK} (*)	00006CD2	
MASSIVE Mode {MAS} (*)		

Control panel parameters

Don't take commands marked with (*) into account: commands not validated for this product or for manufacturer R&D only use.

Command (RS 232 code)	Read value	Parameters command
Panel soft version (*)	001.002.010	[>VER001.002.010]
View curve type (*)	003	[>TCO003]
Graph window time (*)	001	[>WIT001]
Graph sampling time (*)	002	[>SAT002]
High helium decade (*)	-04	[>DHH-04]
Low helium decade (*)	-11	[>DHB-11]
Low bargraph decade (*)	-12	[>DBB-12]
High bargraph decade (*)	-02	[>DBH-02]
High pressure decade (*)	003	[>DPH003]
Low pressure decade (*)	-03	[>DPB-03]
View reject point? (*)	000	[>REP000]
Hardkeys#1 (*)	009000000	[>HK0009000000]
Hardkeys#2 (*)	007000000	[>HK1007000000]
Hardkeys#3 (*)	005000000	[>HK2005000000]
Hardkeys#4 (*)	008000000	[>HK3008000000]
Hardkeys#5 (*)	002000000	[>HK4002000000]

Advanced Menu

Command (RS 232 code)		Read value	Parameters command
Hardkeys#6	(*)	001000000	[>HK5001000000]
Hardkeys#7	(*)	004000000	[>HK6004000000]
Hardkeys#8	(*)	003000000	[>HK7003000000]
Hardkeys#9	(*)	010000000	[>HK8010000000]
Hardkeys#10	(*)	012000000	[>HK9012000000]
Hardkeys#11	(*)	012000000	[>H10012000000]
Hardkeys#12	(*)	012000000	[>H11012000000]
Luminosity setting	(*)	254	[>LUM254]
Ecran#0	(*)	001	[>EC0001]
Ecran#1	(*)	002	[>EC1002]
Ecran#2	(*)	003	[>EC2003]
Ecran#3	(*)	004	[>EC3004]
Panel contrast	(*)	00000	[>COP00000]
Panel off after	(*)	000	[>MVE000]
First screen display	(*)	001	[>APR001]

Factory configuration of the leak detector parameters

Parameters configuration



The following list indicates the factory configuration of the leak detector parameters.

When the leak detector is switched off, all set parameters are memorized and values are kept for the next start-up.

We advise you to note in the "Customer modification" column, the parameter values modified for your application.

The operator can save and load different leak detection configurations. For that, use the functions "Save LD parameters" in the "SD card" advanced menu ( **C 406**).



The saved values are the set values at the saving moment.

	Parameters	Configuration	
		Factory	Customer modification
  C 401	Vacuum reject point	1.0E-07	
	Sniffing reject point	1.0E-04	
	Probe clogged reject point	1.1E-06	
	Alarm	3 - On	
	Digital voice	4 - On	
	He Max.	Off	
	He Max. reject point	1.0E-05	



Factory configuration of the leak detector parameters

	Parameters	Configuration	
		Factory	Customer modification
<div style="background-color: #f4a460; padding: 5px; display: flex; align-items: center;"> Test </div> <div style="margin-top: 5px;"> C 402 </div>	Method	Vacuum	
	Mode	High sensitivity	
	Hard vacuum correction	off	
	Hard vacuum correction value	1.00E+00	
	Sniffing correction	off	
	Sniffing correction value	1.0E+00	
	Cycle end	Operator	
	Roughing time activated	yes	
	Roughing time	00:10	
	Measure time	00:10	
	Inlet vent	Operator	
	Delay	0 s	
	Time activation	off	
Time	10 s		
<div style="background-color: #f4a460; padding: 5px; display: flex; align-items: center;"> Spectro </div> <div style="margin-top: 5px;"> C 403 </div>	Tracer gas	He	
	Location	Internal	
	Calibration valve	Closed	
	Internal calibrated leak value	See the calibration certificate of the internal calibrated leak delivered with the detector	
	Calibration year		
	Unit		
	Loss per year (%/yr)		
	T° Coeff. (%/°C) :		
Ref. T°			
<div style="background-color: #f4a460; padding: 5px; display: flex; align-items: center;"> Maintenance </div> <div style="margin-top: 5px;"> C 404 </div>	Primary pump maintenance counter initial value	10000	
	Secondary pump maintenance counter initial value	15000	
	Cycles maintenance counter initial value	5.00E-05	

Factory configuration of the leak detector parameters

	Parameters	Configuration	
		Factory	Customer modification
 	Language	Configurated by the operator at the 1 st leak detector start up	
	Unit		
	Date		
	Time		
	Password	5555	
	Function keys	config. Level 3	
	Graph application screen selected	yes	
	Vacuum circuit application screen selected	yes	
	Setting application screen selected	yes	
	He high decade	1.0E-2	
	He low decade	1.0E-12	
	Inlet pressure	Show	
	Triode pressure	Hide	
	Stand-by He	On	
	Screen luminosity	high	
	Screen contrast	50 %	
	Panel off	off	
	Set points menu access	yes	
	Test menu access	yes	
	Spectro menu access	yes	
Maintenance menu access	yes		
Config. menu access	yes		
Advanced menu access	yes		

Factory configuration of the leak detector parameters

	Parameters	Configuration	
		Factory	Customer modification
<div style="background-color: #f4a460; padding: 5px; display: inline-block;"> Advanced  </div>  C 406	Memo function activated	no	
	Display timer activated	no	
	Timer (mm:ss)	00:10	
	Background suppression	operator	
	Trigger	set point	
	Value	5.0E-07	
	Timer (mm:ss)	00:10	
	Autocalibration	manual	
	Cal. check	manual	
	Every (cycles)	0050	
	Every (hours)	0010	
	Filament used	1	
	Mode	advanced	
	Period	1 s	
	Handshake	no	

"Setting" menus arborescence

Nota: Values given as example

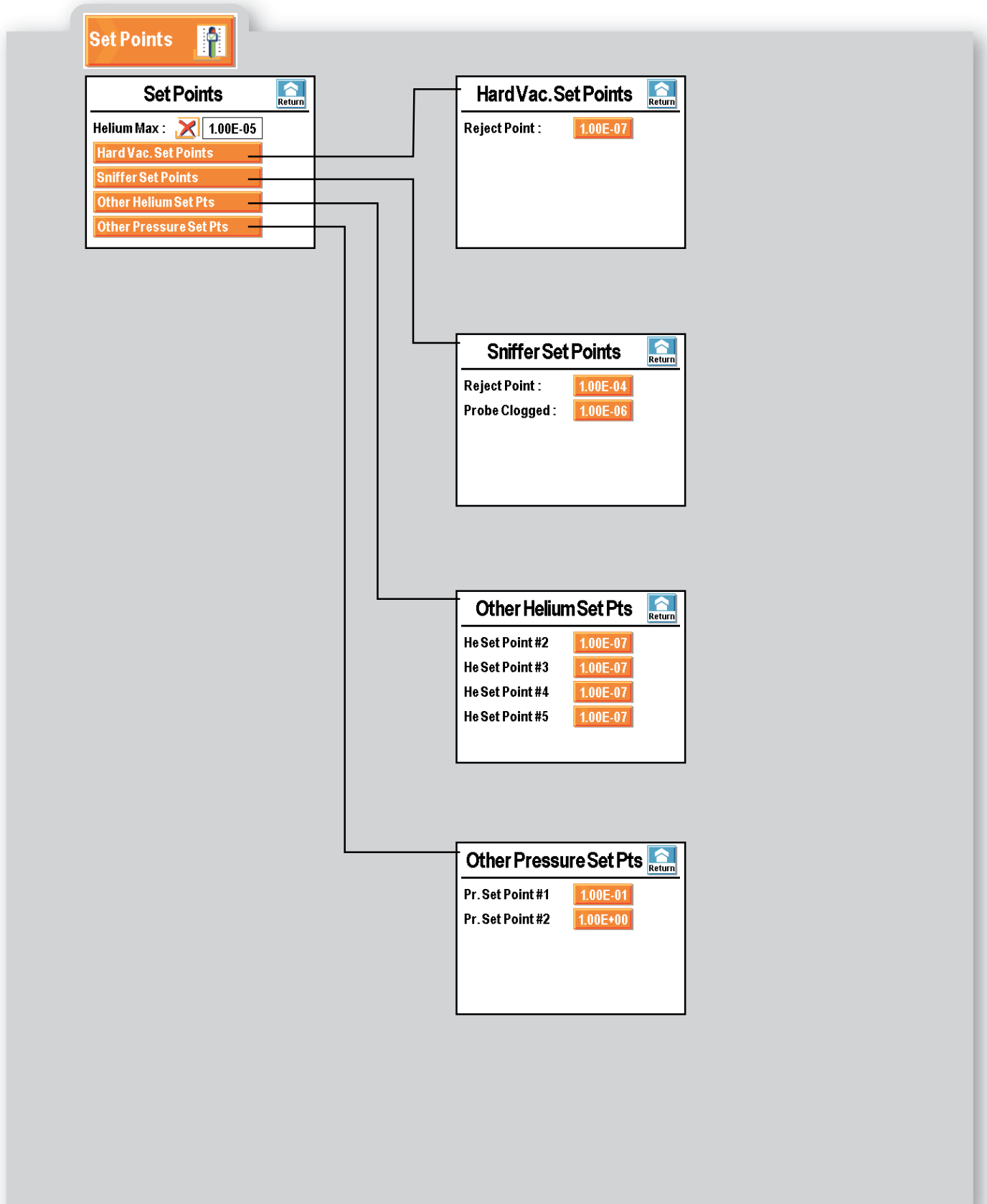

"Setting" menus arborescence

Nota: Values given as example

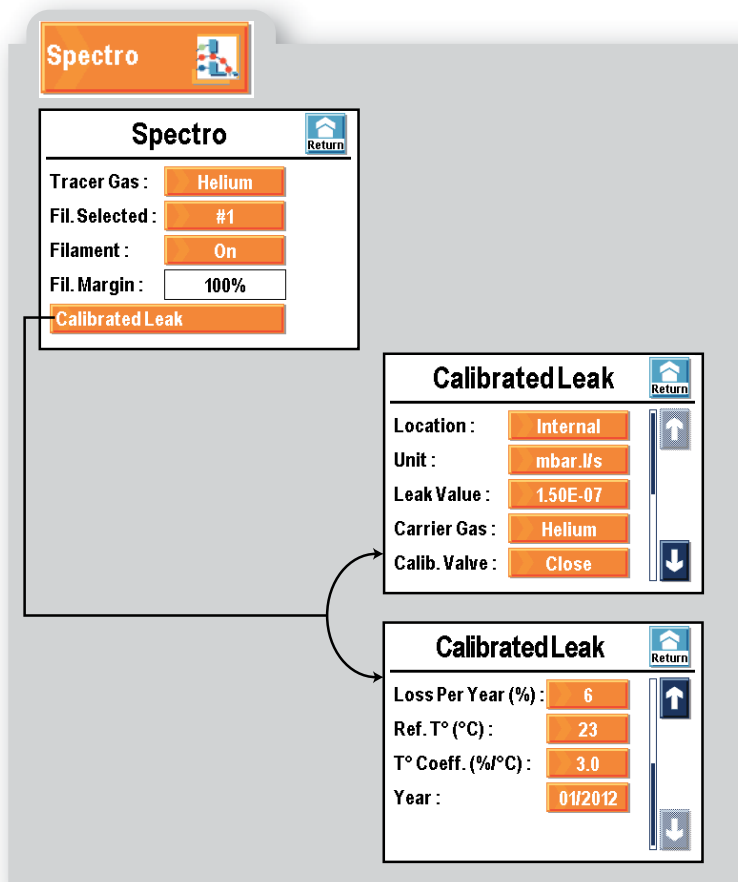
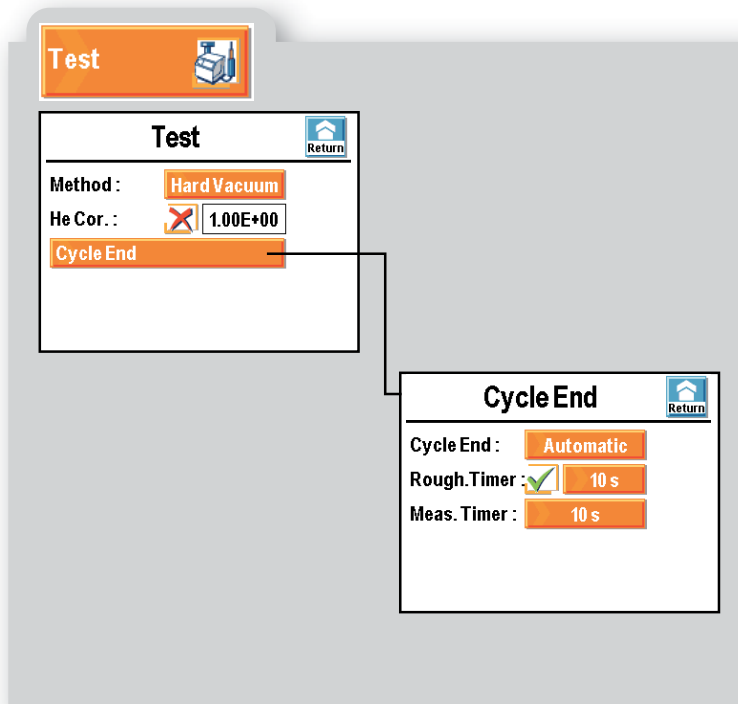

"Setting" menus arborescence

Nota: Values given as example

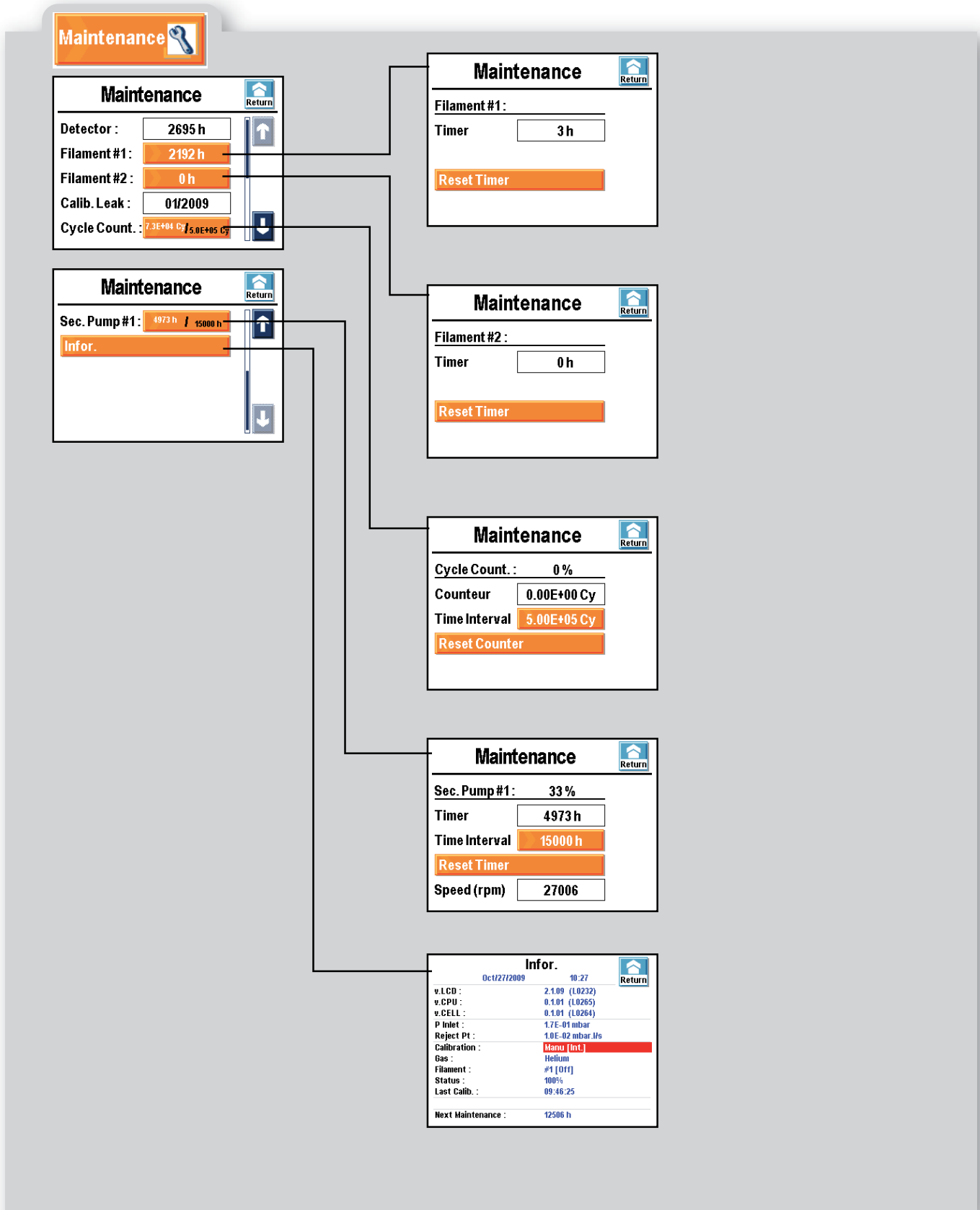

"Setting" menus arborescence

Nota: Values given as example

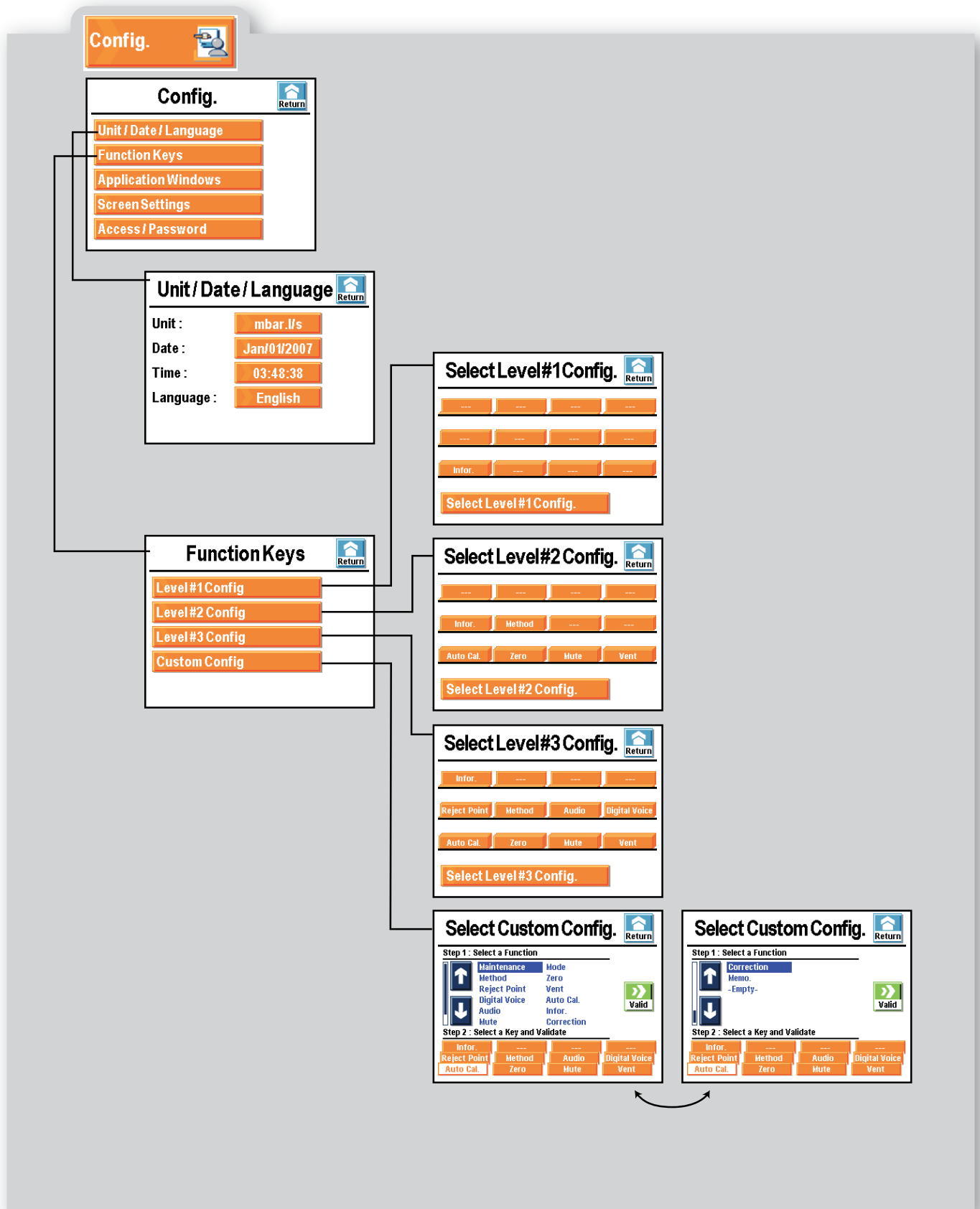

"Setting" menus arborescence

Nota: Values given as example

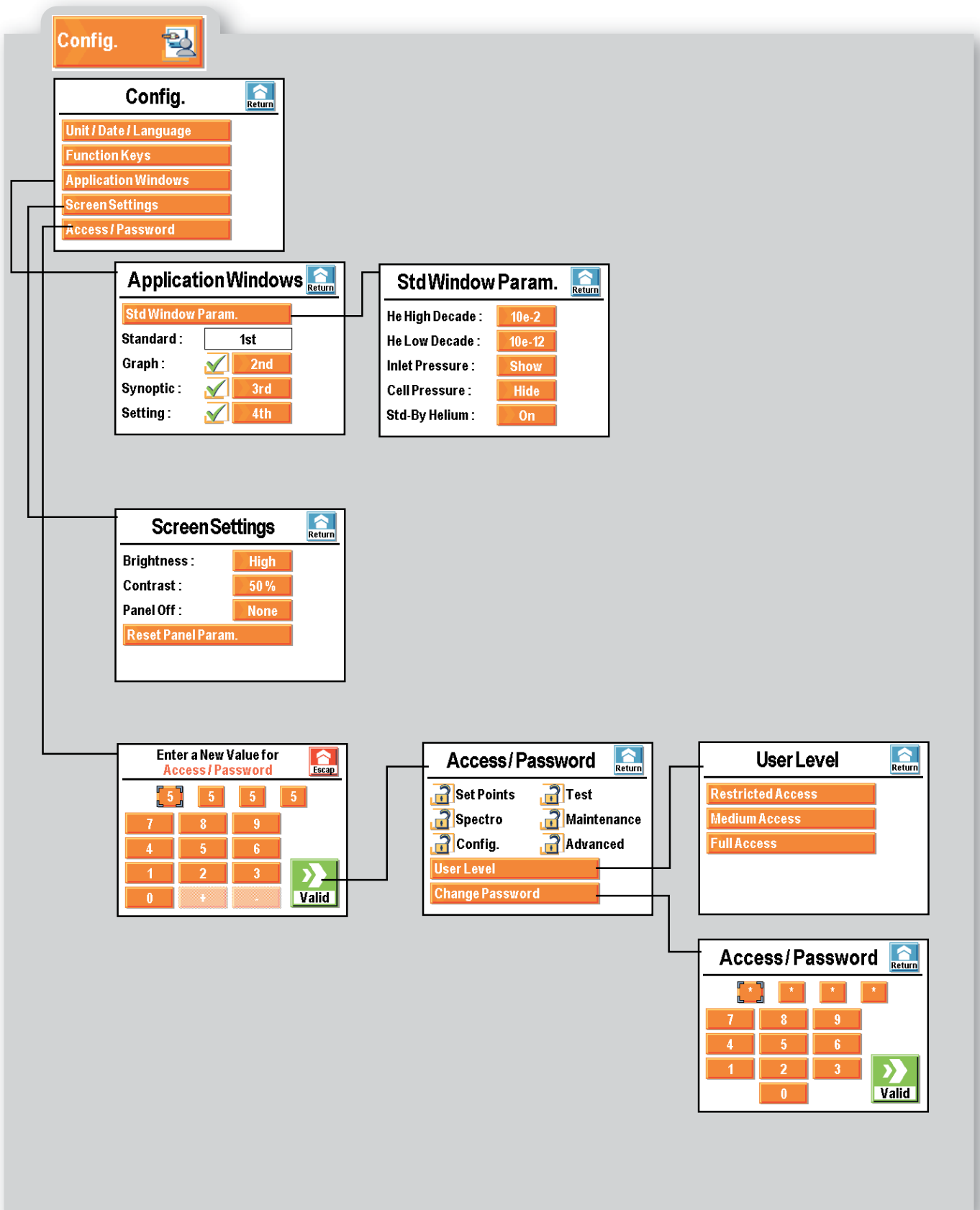

"Setting" menus arborescence

Nota: Values given as exemplel

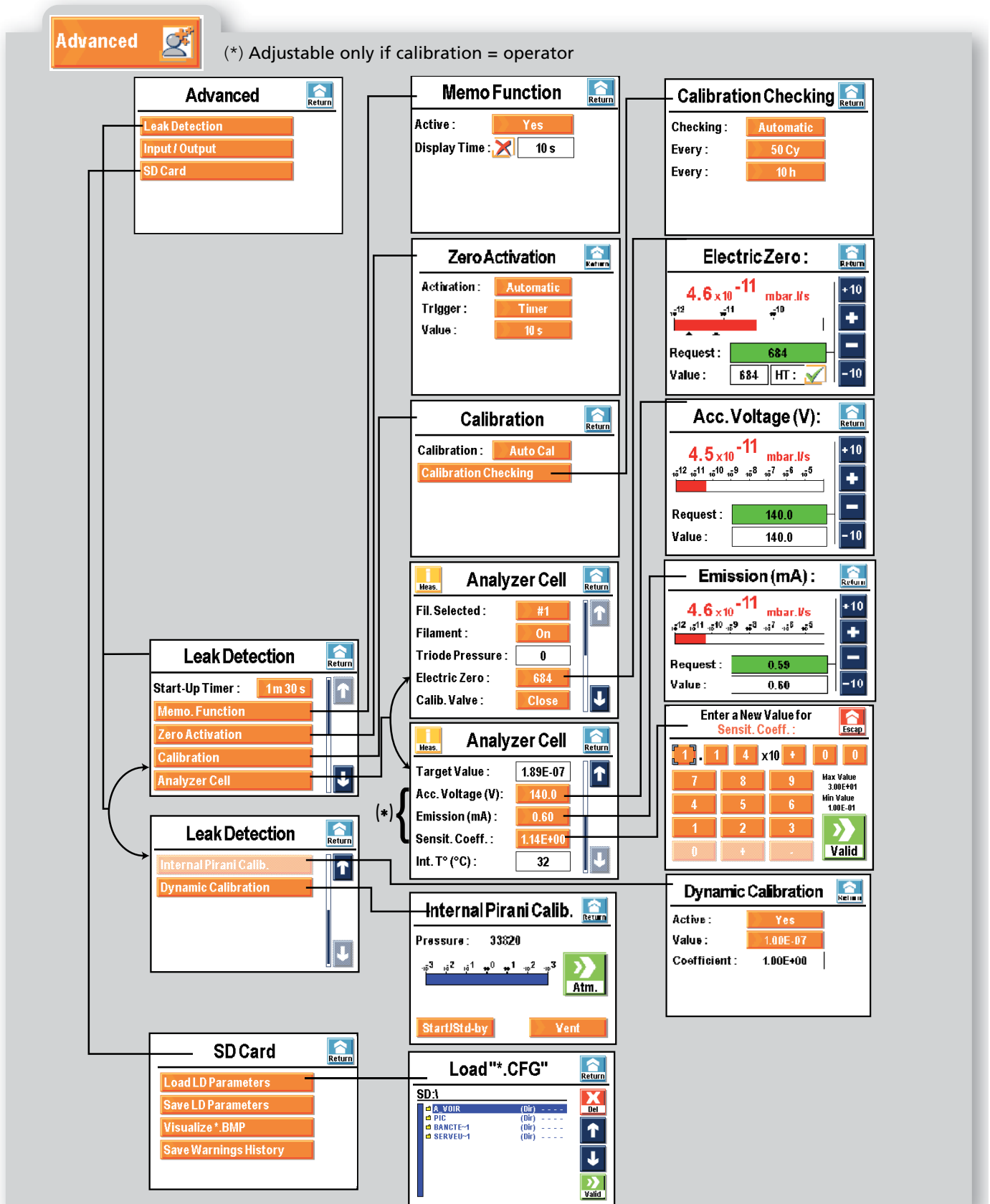

"Setting" menus arborescence

Nota: Values given as example

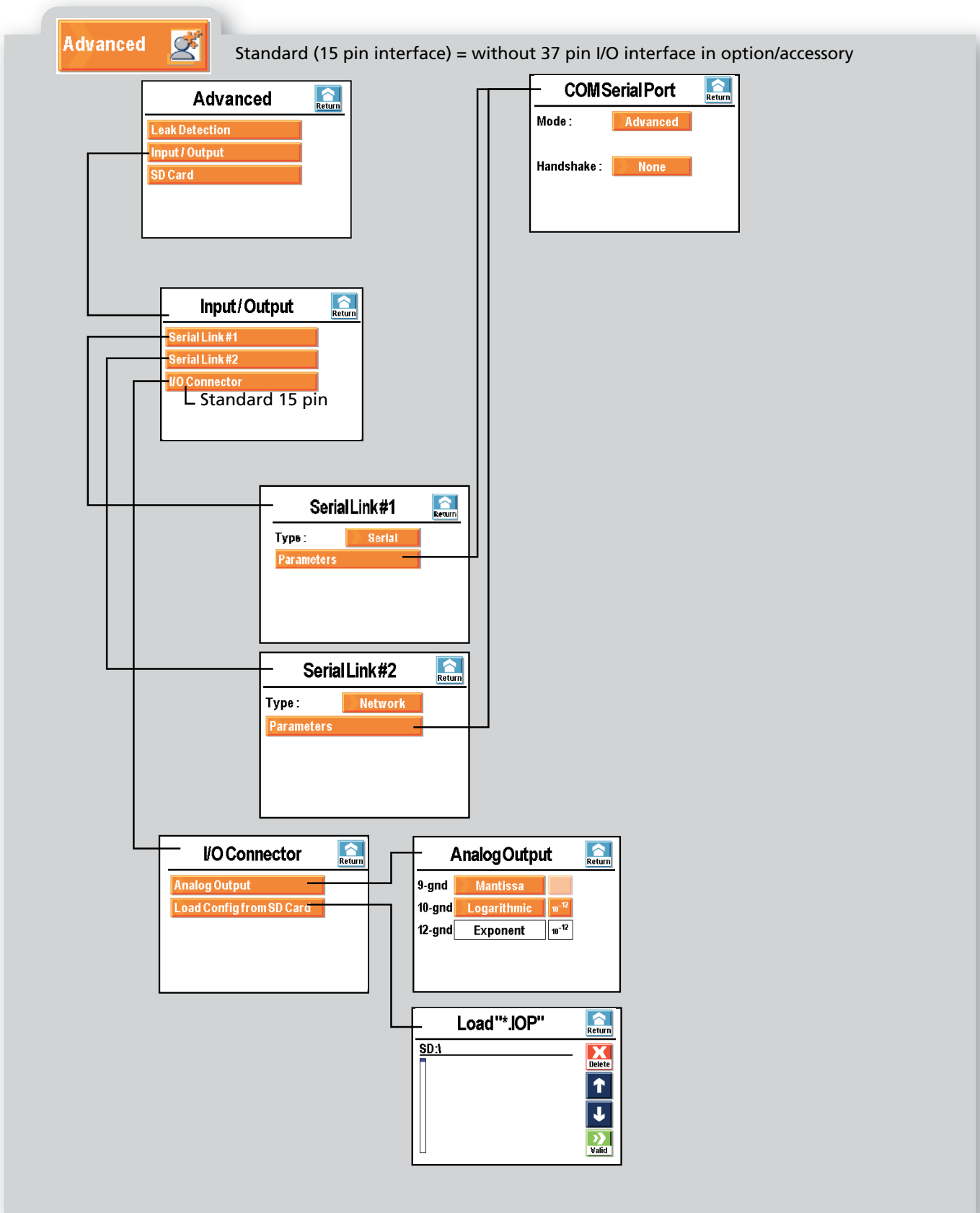

"Setting" menus arborescence

Nota: Values given as example
With 37 pin I/O interface option/accessory

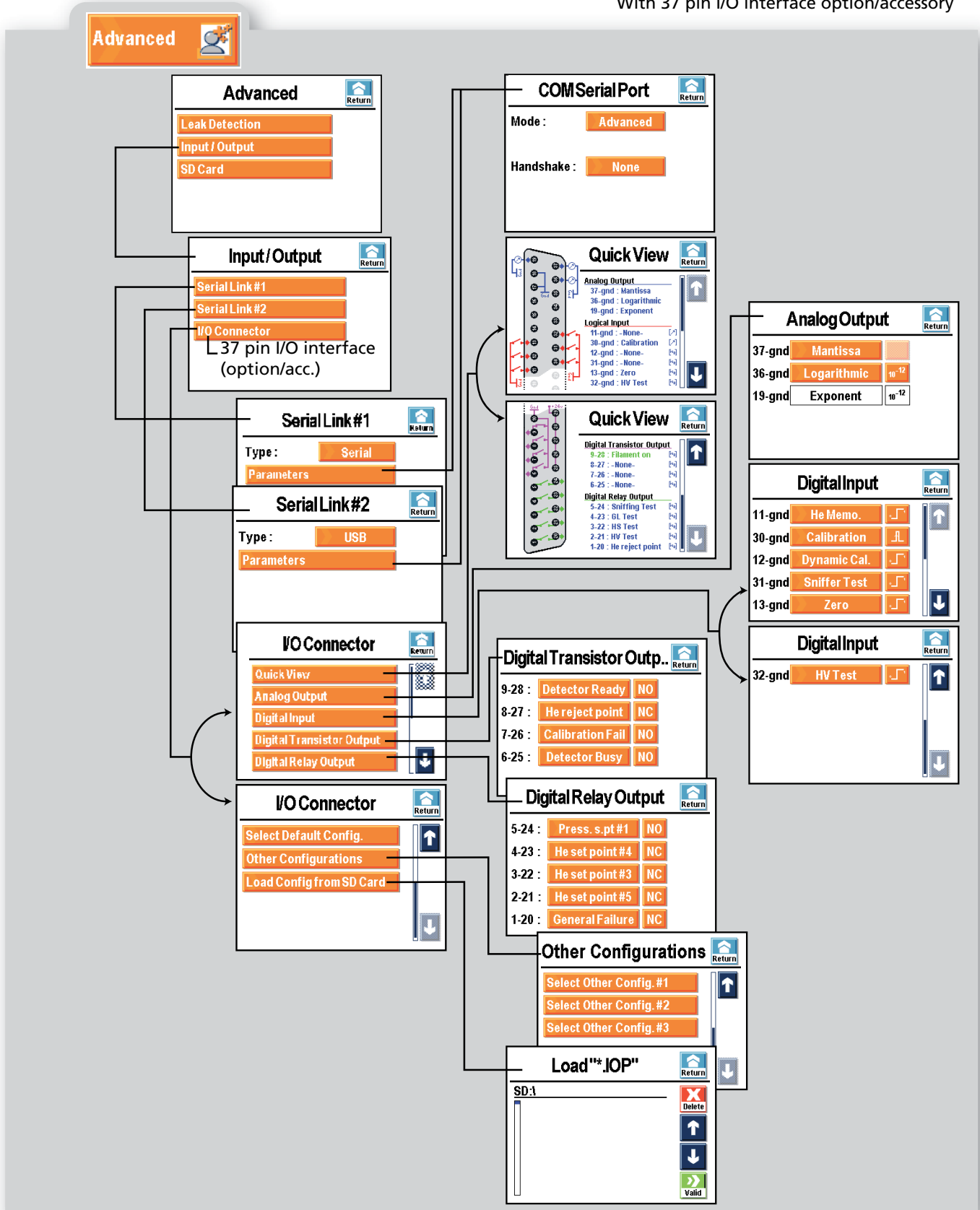

Remote control (accessory)



The remote control is equipped with magnets allowing the operator to place it on a metallic surface. The operator can read the helium signal and has access to control keys such as cycle command, autocalibration and auto-zero.

Interface

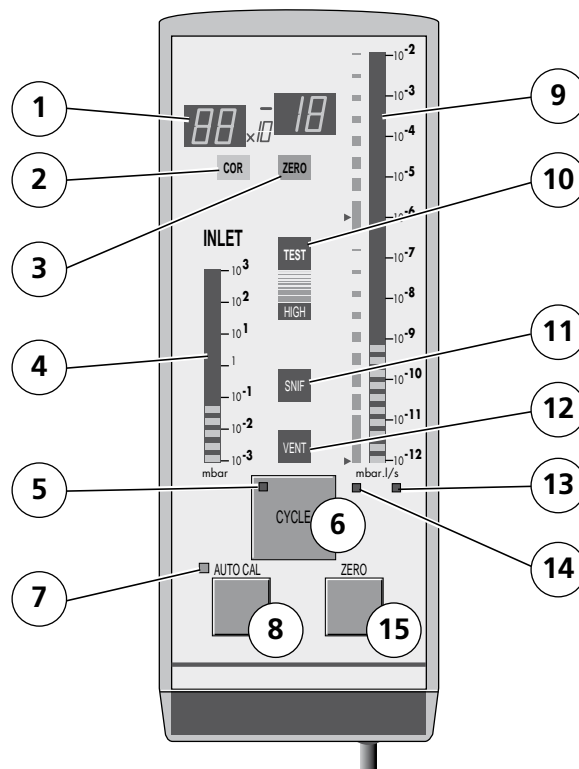

1	Helium Signal digital display	8	Auto-calibration Start/Stop control key
2	Correction factor COR indicator	9	Helium signal analog display
3	Zero function indicator	10	Test ON indicator
4	Inlet port pressure analog display	11	Sniffing test mode ON indicator
5	Test ON indicator (ON when activated)	12	Inlet VENT ON indicator
6	Test Start/Stand-by control key	13	Helium signal standard scale ON indicator
7	Calibration in progress indicator	14	Helium signal Zero scale ON indicator
		15	Zero ON/OFF control key

Remote control (accessory)

Connecting

 B 210

Choice 3 different units can be selected in the leak detector but only one unit is available on the remote control.

So the operator should choose the remote control according to of the operation unit chosen.

Units  C 405

Accessories  A 400

When the operator connects the remote control to the leak detector, the leak detector unit is automatically reprogrammed with the unit of the remote control. The remote control unit is memorized by the detector when the operator disconnects the remote control.

Use and display

The remote control:

- displays the leak rate value,
- controls the start/stop cycle, zero function and internal calibration,
- displays the status of the air inlet vent, sniffing test mode and external calibration,
- does not allow to adjust leak detector parameters.

Analog and digital displays

On the remote control and control panel, the displayed values on the analog and digital displays are exactly the same.

To start/stop a cycle



In order to start/stop a cycle, operator can use either the control key on the control panel or remote control.



Display

The LED indicator is ON/OFF when the control key is activated/deactivated: if the led is OFF, the leak detector is in stand-by.

As soon as the detector is in test, the TEST indicator is ON.

Remote control (accessory)

Use and display (ctd)

Zero function

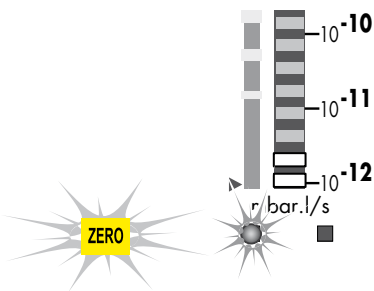

In order to start the zero function, operator can use the ZERO control key on either the control panel or the remote control.

Display

Two indicators are ON when the zero function is activated:

- the ZERO indicator,
- the zero scale indicator.

Zero function C 406

Autocalibration



In order to start an internal auto-calibration, the operator can use the AUTOCAL function key on either the control panel or the remote control.

Display

The LED indicator is ON when the control key is activated.

The LED indicator is OFF at the end of the calibration procedure.

Calibration of the leak detector C 406

Inlet vent Sniffing test mode



For these 2 functions, the remote control displays only their status: use

the control panel in order to activate/deactivate them. C 402

Display

The LED indicator is ON/OFF when the function is activated/deactivated.

External calibration



The remote control displays only its status: use the control panel in order to start/stop it.

Display

The LED indicator is blinking when the external calibration is activated.

At the end of the calibration procedure, the LED indicator is OFF and the correction factor COR is ON.

External calibration E 410

Long distance sniffer probe and Helium spray gun (accessories)

Please refer to the specific sheets for the instruction:



Long distance sniffer probe



Helium spray gun  **G 500**

Declaration of conformity



DECLARATION OF CE CONFORMITY

We, **adixen Vacuum Products**
98, avenue de Brogny · BP2069
74009 Annecy cedex – France

ISO 9001 CERTIFIED

declare under our sole responsibility that the following products:

ASM310

to which this declaration relates are in conformity with the relevant provisions of the following European Directives:

2006/042/EC: Machinery directive

2006/095/EC: Low voltage directive

2004/108/EC: Electromagnetic Compatibility Directive

2002/095/EC: Restriction of Hazardous Substances

2002/096/EC: Waste of Electrical and Electronical Equipments

when used in accordance with the instruction manual of the product.

Those products comply with the relevant provisions of the above Directives and carry the CE marking.

Signatures:

Annecy, September 13, 2012

Authorized person to compile the relevant technical documentation:



Mr. Eric TABERLET
President



Mr. Gilles BARET
Products and Technology Director
98, avenue de Brogny · BP 2069 / 74009 Annecy - France

Service

Pfeiffer Vacuum offers first-class customer service!

- On-Site maintenance for many products)
- Overhaul / repair in the nearby Service Location
- Fast replacement with refurbished exchange products in mint condition
- Advice on the most cost-efficient and quickest solution

Detailed information, addresses and forms at: www.pfeiffer-vacuum.com (Service).

Overhaul and repair in the Pfeiffer Vacuum Service Center

The following general recommendations will ensure a fast, smooth servicing process:

- ➔ Fill out the «Service Request/Product return» form and send it to your local Pfeiffer Vacuum Service contact.
- ➔ Include the confirmation on the service request from Pfeiffer Vacuum with your shipment.
- ➔ Fill out the declaration of contamination and include it in the shipment (mandatory!). The Declaration of contamination is valid for any product/device including a part exposed to vacuum.
- ➔ Dismantle all accessories and keep them.
- ➔ Close all the ports flange openings by using the original protective covers or metallic airtight blank flanges for contaminated devices.
- ➔ If possible, send pump or unit in its original packaging.

Sending of contaminated pumps or devices

No devices will be accepted if they are contaminated with micro-biological, explosive or radioactive substances. "Hazardous substances" are substances and compounds in accordance with the hazardous goods regulations (current version).

- ➔ Neutralize the pump by flushing it with nitrogen or dry air.
- ➔ Close all openings airtight.
- ➔ Seal the pump or device in suitable protective film.
- ➔ Return the pump/device only in a suitable and sturdy transport container and send it in while following applicable transport conditions.

Pump or device returned without declaration of contamination form fully completed and/or non-secured in a suitable packaging, will be decontaminated and/or returned at the shipper's expense.

Exchange or repaired devices

The factory operating parameters are always preset with exchange or repaired devices. If you use specific parameters for your application, you have to set these again.

Service orders

All service orders are carried out exclusively according to our general terms and conditions for the repair and maintenance, available in our website.

**Vacuum Solutions
from a single Source**

Pfeiffer Vacuum stands for innovative and custom vacuum solutions worldwide, technological perfection, competent advice and reliable service.

**Complete range
of products**

From a single component to complex systems: We are the only supplier of vacuum technology that provides a complete product portfolio.

**Competence in
theory and practice**

Benefit from our know-how and our portfolio of training opportunities! We support you with your plant layout and provide first-class on-site service worldwide.

**Are you looking for a
perfect vacuum solution?
Please contact us:**

Pfeiffer Vacuum GmbH
Headquarters
T +49 6441 802-0
Info@pfeiffer-vacuum.de

