



Neo-cool Circulator

Model

CF800

Instruction Manual

- Second Edition -

- Thank you for purchasing " Neo-cool Circulator, CF 800" of Yamato Scientific Co., Ltd.
- To use this unit properly, read this "Instruction Manual" thoroughly before using this unit. Keep this instruction manual around this unit for referring at anytime.

⚠ WARNING!

Carefully read and thoroughly understand the important warning items described in this manual before using this unit.

**Yamato Scientific America Inc.
Santa Clara, CA**

Contents

◆ Cautions in Using with Safety	1
• Explanation	1
• Table of Illustrated Symbols	2
• Fundamental Matters of “WARNING!” and “CAUTION!”	3
◆ Before Using this unit	5
• Requirements for Installation.....	5
◆ Description and Function of Each Part	10
• Main Unit and Control panel.....	10
◆ Installation Method	12
◆ Operation Method	14
• Procedure of Operation.....	14
• Heating and cooling curve, cooling capacity curve (reference data)	15
• Flow Rate and Head (reference data).....	16
• Selecting heat medium for lower temperature (reference data)	17
◆ Handling Precautions	18
◆ Maintenance Method	21
• Daily Inspection and Maintenance.....	21
◆ Long storage and disposal	23
• When not using this unit for long term / When disposing	23
• Notes about disposition.....	23
◆ In the Event of Failure	24
◆ After Service and Warranty	25
◆ Specification	26
◆ Wiring Diagram	27
◆ Replacement Parts Table	28
◆ Reference	29
• List of Dangerous Substances	29
◆ Standard installation manual	30

Explanation

MEANING OF ILLUSTRATED SYMBOLS

Illustrated Symbols

Various symbols are used in this safety manual in order to use the unit without danger of injury and damage of the unit. A list of problems caused by ignoring the warnings and improper handling is divided as shown below. Be sure that you understand the warnings and cautions in this manual before operating the unit.

 **WARNING!** If the warning is ignored, there is the danger of a problem that may cause a serious accident or even fatality.

 **CAUTION!** If the caution is ignored, there is the danger of a problem that may cause injury/damage to property or the unit itself.

Meaning of Symbols



This symbol indicates items that urge the warning (including the caution). A detailed warning message is shown adjacent to the symbol.



This symbol indicates items that are strictly prohibited. A detailed message is shown adjacent to the symbol with specific actions not to perform.



This symbol indicates items that should be always performed. A detailed message with instructions is shown adjacent to the symbol.

Cautions in Using with Safety

Table of Illustrated Symbols

Warning



Warning,
generally



Warning,
high voltage



Warning,
high temperature



Warning,
drive train



Warning,
explosive

Caution



Caution,
generally



Caution,
electrical shock



Caution,
scald



Caution,
no road heating



Caution,
not to drench



Caution,
water only



Caution,
deadly poison

Prohibit



Prohibit,
generally



Prohibit,
inflammable



Prohibit,
to disassemble



Prohibit,
to touch

Compulsion



Compulsion,
generally



Compulsion,
connect to the
grounding
terminal



Compulsion,
install on a flat
surface



Compulsion,
disconnect the
power plug



Compulsion,
periodical
inspection

Cautions in Using with Safety

Fundamental Matters of “WARNING!” and “CAUTION!”

WARNING!

Do not use this unit in an area where there is flammable or explosive gas

Never use this unit in an area where there is flammable or explosive gas. This unit is not explosion-proof. An arc may be generated when the power switch is turned on or off, and fire/explosion may result. (Refer to page29 “List of Dangerous Substances”.)

Always ground this unit

Always ground this unit on the power equipment side in order to avoid electrical shock due to a power surge.

If a problem occurs

If smoke or strange odor should come out of this unit for some reason, turn off the power key right away, and then turn off the circuit breaker and the main power. Immediately contact a service technician for inspection. If this procedure is not followed, fire or electrical shock may result. Never perform repair work yourself, since it is dangerous and not recommended.

Do not use the power cord if it is bundled or tangled

Do not use the power cord if it is bundled or tangled. If it is used in this manner, it can overheat and fire may be caused.

Do not process, bend, wring, or stretch the power cord forcibly

Do not process, bend, wring, or stretch the power cord forcibly. Fire or electrical shock may result.

Pay special attention to the measure for flammability and handling of flammable solvent

Leaving at the temperature higher than the room temperature may vaporize the flammable material (ethanol, etc.). There might be the case that some flammable liquid might be vaporized at the temperature lower than the room temperature. The result of such careless handling could cause the fire or explosion. Do provide the vaporization with enough during the operation.

Never try to touch a hot part.

Some parts of the unit are hot during and immediately after operation. Take special care for possible burning.

Do not disassemble or modify this unit

Do not disassemble or modify this unit. Fire or electrical shock or failure may be caused.

Fundamental Matters of “WARNING!” and “CAUTION!”

CAUTION!



When a thunder is heard

When a thunder is heard, turn the main power off immediately. A malfunction, fire or an electrical shock may result.



Do not touch the cooling fin with bare hands

Do not touch the cooling fin with bare hands during maintenance, for the edge of the cooling fin is too sharp to cut your hand.

Requirements for Installation

WARNING!

1. Be sure to connect the ground wire.

 • When the unit has no ground terminal, class D grounding work is necessary and please consult your dealer or our nearest sales office.

 • Securely connect to a distribution board or an outlet.

M5 round terminal

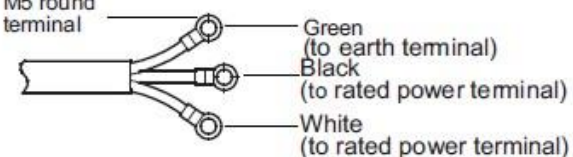

The unit does not have a power plug. Connect the earth correctly to suit the power facility to be connected.

 Do not connect the grounding wire to any parts or lines other than a correct grounding terminal such as a gas pipe, a water pipe or a telephone line. Otherwise, an accident or a malfunction may result.

2. Choose a proper place for installation

 • Do not install this unit in a place where:

- ◆ Rough or dirty surface.
- ◆ Flammable gas or corrosive gas is generated.
- ◆ Ambient temperature below 5°C or above 35°C.
- ◆ Ambient temperature fluctuates violently.
- ◆ There is direct sunlight.
- ◆ There is excessive humidity and dust.
- ◆ There is a constant vibration.
- ◆ Outdoor

 • Install this unit on a stable place with the space as shown below.

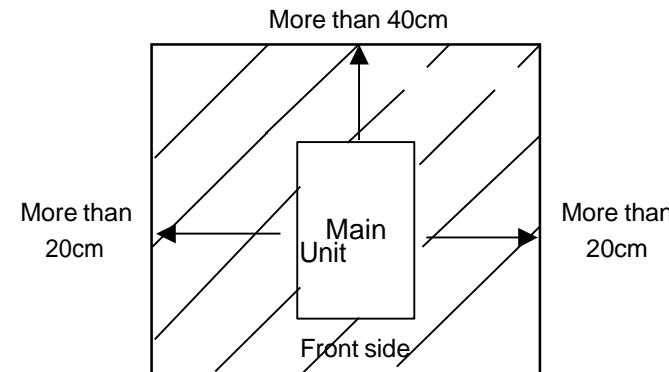

Before Using this unit

Requirements for Installation

3. Do not use this unit in an area where there is flammable or explosive gas



- Never use this unit in an area where there is flammable or explosive gas. This unit is not explosion-proof. An arc may be generated when the power switch is turned ON or OFF, and fire/explosion may result.
- To know about flammable or explosive gas refer to page29 "List of Dangerous Substances".

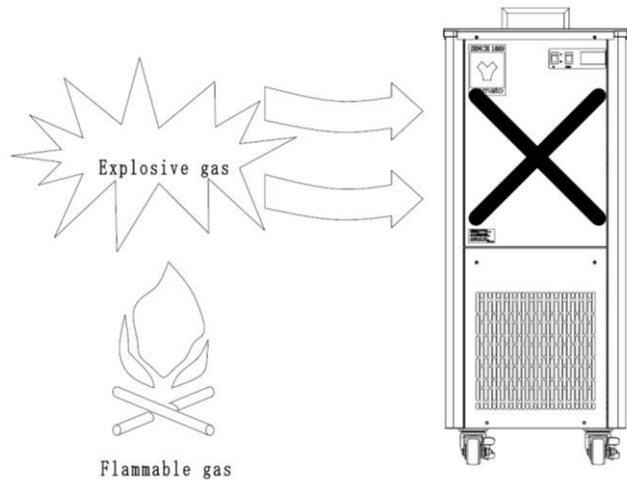

4. Do not modify



- Modification of this unit is strictly prohibited. This could cause a failure.

Modification

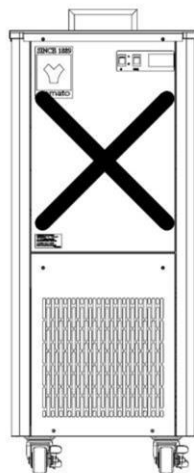

5. Do not topple or tilt this unit



- Set this unit to the flattest place. This unit incorporates the refrigerator. Do not topple or tilt it.

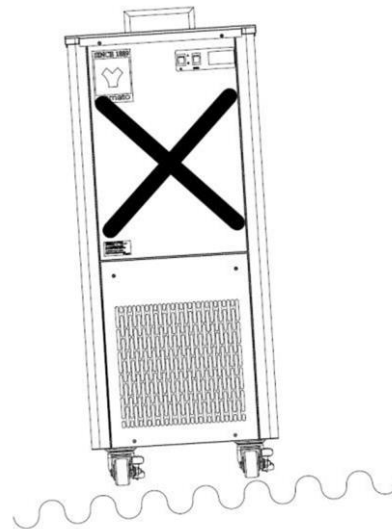

CAUTION!

6. Use specified receptacle for power source



- Choose a correct power distribution board or receptacle that meets the unit's rated electric capacity.

Electric capacity: 115V AC, 50/60Hz, 12.5A(I include service outlet AC115V 3A)

NOTE)

Starburst connection with a branching receptacle or extended wiring with a cord reel lowers electrical power voltage, which may cause the degradation of refrigeration capability.

Requirements for Installation

7. Before/after installing



- It may cause injury to a person if this unit falls down or moves by the earthquake and the impact. etc..To prevent, take measures that the unit cannot fall down, and not install to busy place.
- Though this unit has the air-cooled refrigerator, the device exhausts the heat. Do provide the vaporization with enough so as not to raise the ambient temperature caused by the exhaust of the heat, or install this unit with its air controlled completely. If the ambient temperature becomes high, the operation efficiency becomes worse, and could cause the malfunction of the device by high temperature and humidity.

8. Handling of power code



- Do not entangle the power cord. This will cause overheating and possibly a fire.
- Do not bend or twist the power cord, or apply excessive tension to it. This may cause a fire and electrical shock.
- Do not lay the power cord under a desk or chair, and do not allow it to be pinched in order to prevent it from being damaged and to avoid a fire or electrical shock.
- Keep the power cord away from any heating equipment such as a room heater. The cord's insulation may melt and cause a fire or electrical shock.



- If the power cord becomes damaged (wiring exposed, breakage, etc.), immediately turn off the power at the rear of this unit and shut off the main supply power. Then contact your nearest dealer for replacement of the power cord. Leaving it may cause a fire or electrical shock.
- Connect the power plug to the receptacle which is supplied appropriate power and voltage.

9. Before/after installing



- Connect the circulation port of the main body to the coolant device securely so as not to leak cooling liquid.
- Closing the circulation path with the solenoid valve or throttle valve might cause the malfunction of the pump such as water leakage.
- Please open the stop valve discharge and the return at the time of the pump driving by all means.
- Pay attention to the over-throttle. Keep minimum flow rate of circulating solution more than 10% of Pump Max.Flow Rate according to Specification Table on page 26.
- In case that there are solenoid valve on the device to be performed the circulation cooling, or in case that the flow rate of the device is lower than the 1.5 liter per min. set the bypass circuit between the main device and peripheral devices.

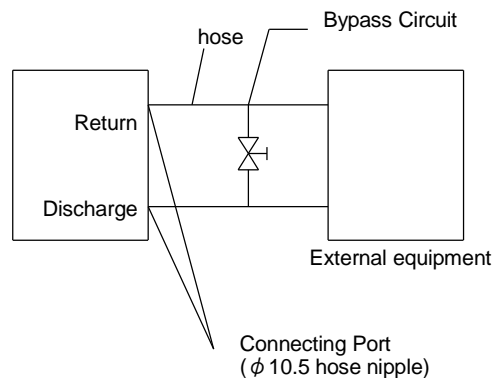

Requirements for Installation

10. Secure sufficient ventilation for the unit.



Do not operate the unit when its side panels and vent holes are blocked. Internal temperature of the unit will rise degrading the performance and an accident, a malfunction or a fire may result.

11. Do not operate the unit at such a place that may subject to splash.



Do not operate the unit at such a place that may subject to splash. Liquid entering the inside may cause an accident, a malfunction, an electrical shock or a fire.

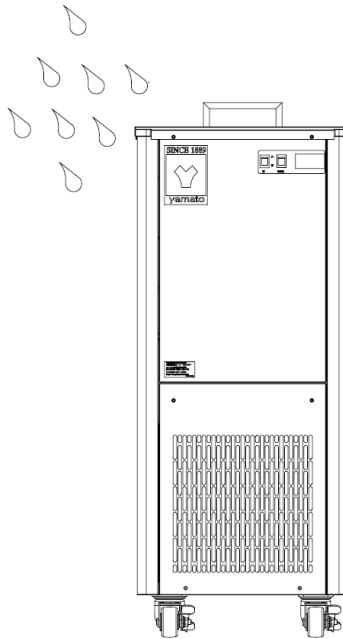

12. Do not use liquid other than water and antifreezing liquid (Nybrine[®], ethylene glycol)



- Pour distilled water or tap water into the water tank. Water of poor quality may cause fur or scale to accumulate on the heater pump, which may result in deteriorated performance or malfunction (e.g. well water, etc.).
- When you use circulation liquid have a high degree of inflammability such as ethanol, please perform sufficient ventilation and do not bring close what becomes fire and a source of ignition by any means.
- A circulating liquid with high specific gravity or highly viscosity places overburden on the circulating pump and damages the unit (e.g. Fluorinert, Galden, etc.).
- A corrosive liquid or a liquid that produces corrosive substances when heated may cause malfunction (e.g. Fluorinate). Also when you mix an antiseptic with an antifreeze solution, please choose a thing without corrosiveness. (Main parts : Stainless steel plate, Copper, Nickel plate, Silicon rubber)
- Do not use any liquid whose vapor is toxic or hazardous because it may result in an accident (methyl alcohol, etc.).

Requirements for Installation

13. Choose circulating liquid according to its operating temperature.



- Choose circulating liquid according to its operating temperature.
 Target Temperature more than 10°C : City Water(or soften Industrial Water)
 Target Temperature less than 10°C : Nonfreezing Solution(recommend Naiburain solution diluted by City Water)
 ※Never choose pure water and/or deionized water as circulating liquid.
 Make the line up of concentration adjusted Naiburain solution so called Luck-rack Solution as Yamato Products.
 Please contact with local dealer or Yamato sales office and ask for Luck-rack Solution.

Product Name	Product Code	Concentration (W t%)	STD Target Temperature	Package Volume (in liters)
Luck-rack Solution: Z16005	756071	60%	-20°C	5L
Luck-rack Solution: Z16010	756072			10L
Luck-rack Solution: Z10005	756073	100%	-30°C	5L
Luck-rack Solution: Z10010	756074			10L
Luck-rack Solution: NFP6005	756075	60%	-10°C	5L
Luck-rack Solution: NFP6010	756076			10L

May cause failure of this Equipment/Unit so that pay attention to notices below.

- May degrade the concentration percentage of nonfreezing solution for many months operation. Check concentration percentage of nonfreezing solution and/or change the whole quantity of nonfreezing solution by every 6(six) months as the standard.
- Change the whole quantity of city water by every 3(three) months as the standard.
- Never choose disqualified water(such as well water etc.), or pure water and deionized water as circulating liquid.
- May not meet with the Equipment/Unit performance because circulating pump will be overworked, if apply high specific gravity and/or high viscosity liquid such as Fluorinert(by 3M) and GALDEN(by Daitoku Tech) etc.
- Never apply following solution to this Equipment/Unit.
 - 1) Corrosive solution, and /or
 - 2) Solution to generate corrosives at heating such as Fluorinert(by 3M) etc.
 - 3) Solution to be harmed human body by absorbing its evaporating gas such as methanol
 Check component materials to contact with solution below, choose adequate disinfectant, mix it with circulating solution, and then apply.
 (Component materials to contact with solution:
 Stainless Steel, Copper w/nickel plated, Silicon Rubber)
- Be careful flammable solution to apply as nonfreezing solution such as ethanol, etc.
 - 1) Ventilate laboratory/room well.
 - 2) Never bring fire and igniting source(static electricity etc.) close to this Equipment/Unit.

Description and Function of Each Part

Main Unit and Control panel

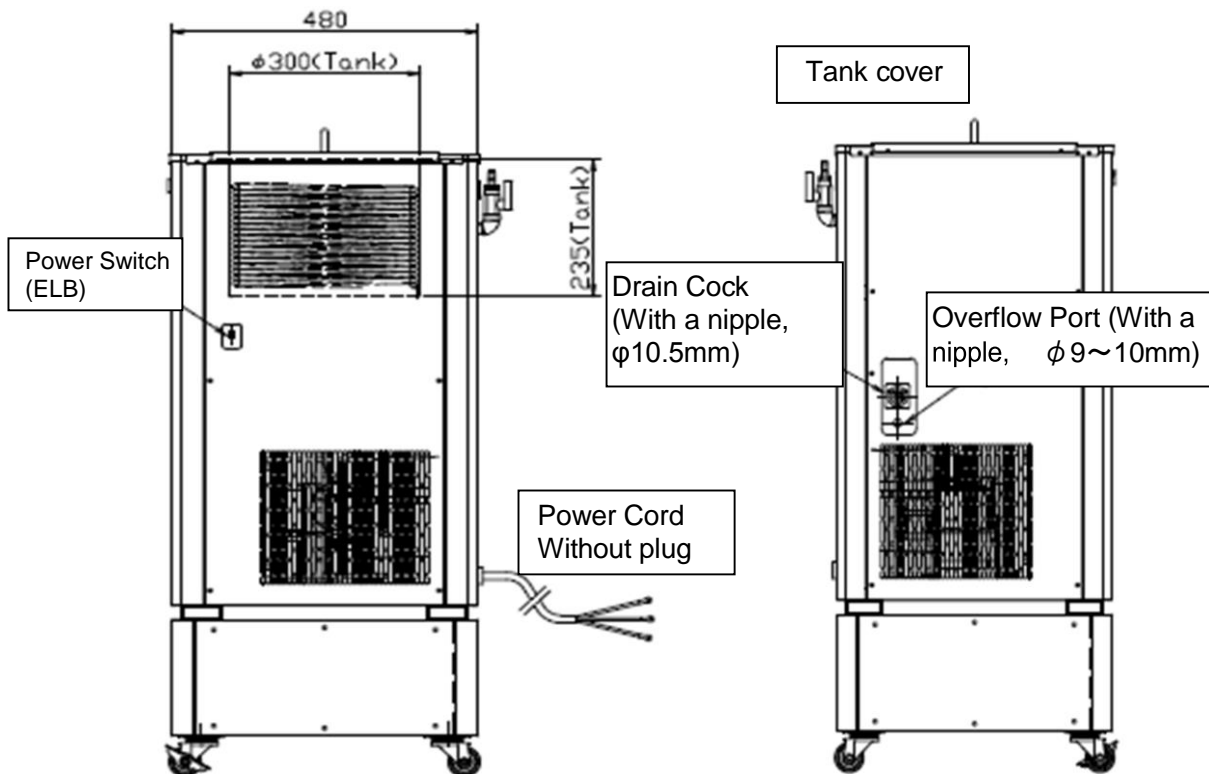
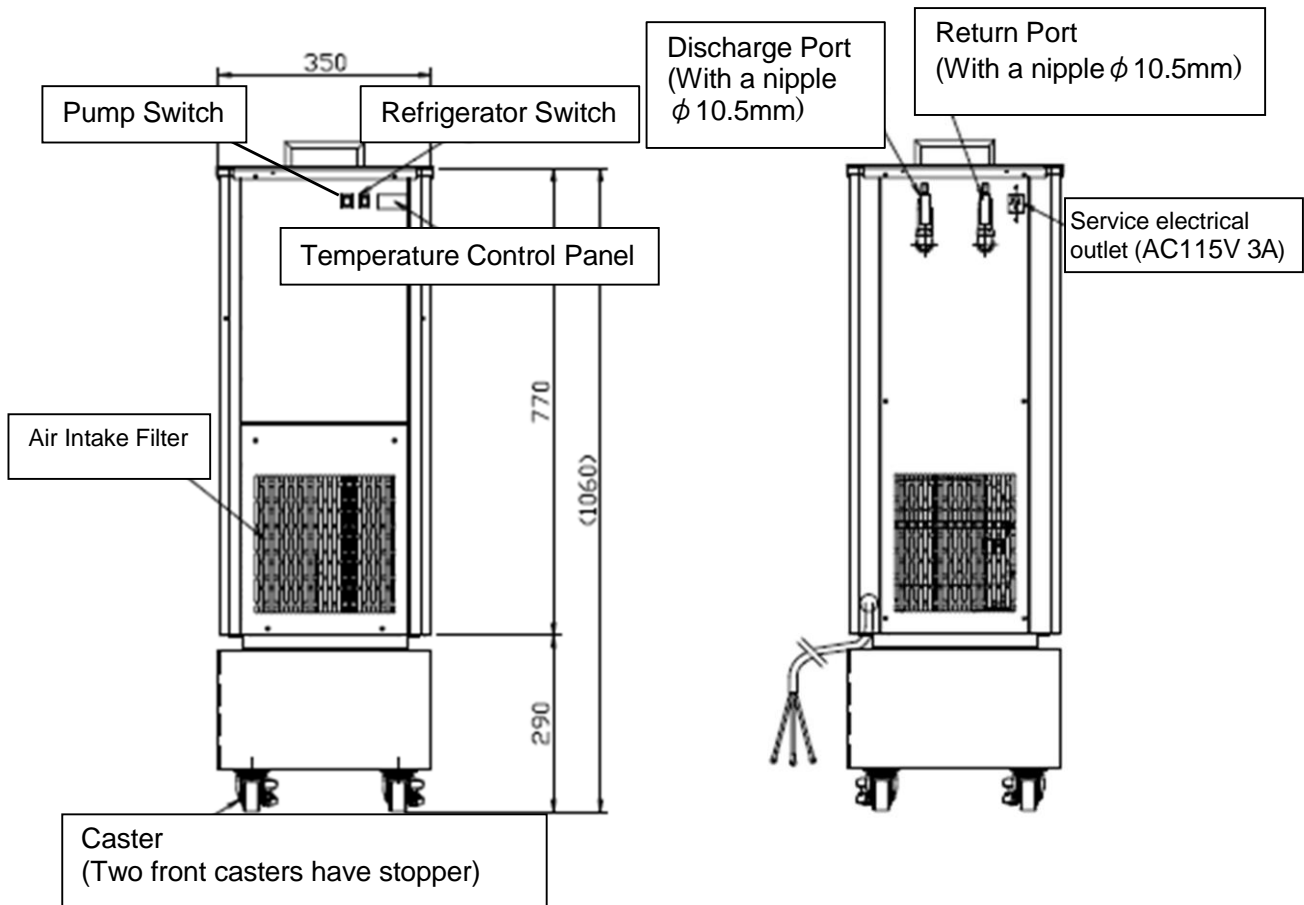

Description and Function of Each Part

Main Unit and Control panel

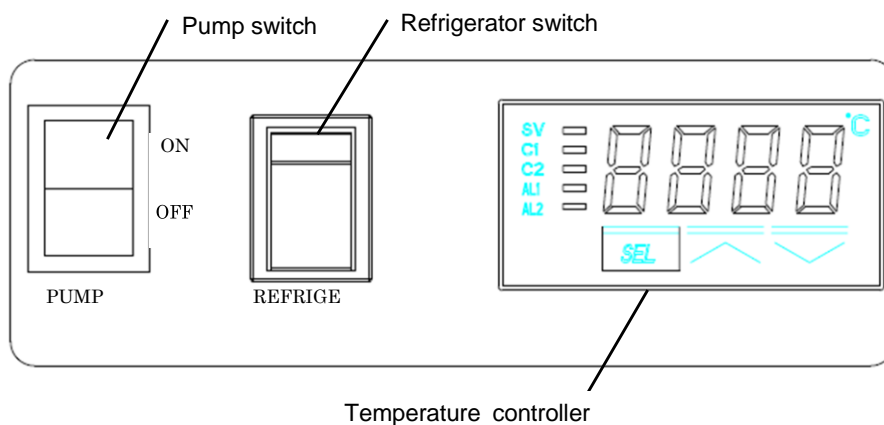

Part Name	Function
Power switch (Earth Leakage Breaker) :	This is the power switch Turns ON/OFF the main power.
Temperature controller :	Controls the temperature of cooling liquid in the bath. (Range: -20 to 30°C)
Refrigerator switch :	Turns ON/OFF the refrigerator.
Pump switch :	Turns ON/OFF the circulation pump.

1. Unlock the stopper of the caster.
Pulling up the lever of the stopper for
caster releases the lock.

(Only the two casters in front of the unit
are attached the stopped.)

2. Move the device to the place to be
installed.
❖ If there is a step on the floor, the too strong
impact is given to the caster, and could
give the damage. In that case, move the
device by lifting at the step.

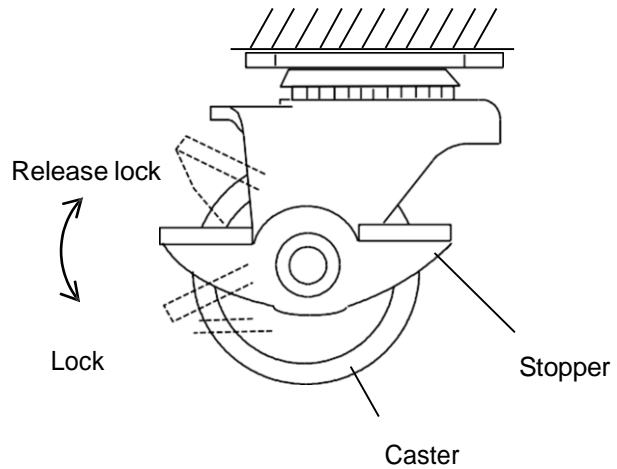

3. When the installation place is determined,
pull down the lever of the stopper for
caster, and lock them.

4. Check that the drain cock valve is set at
the "CLOSE" position.

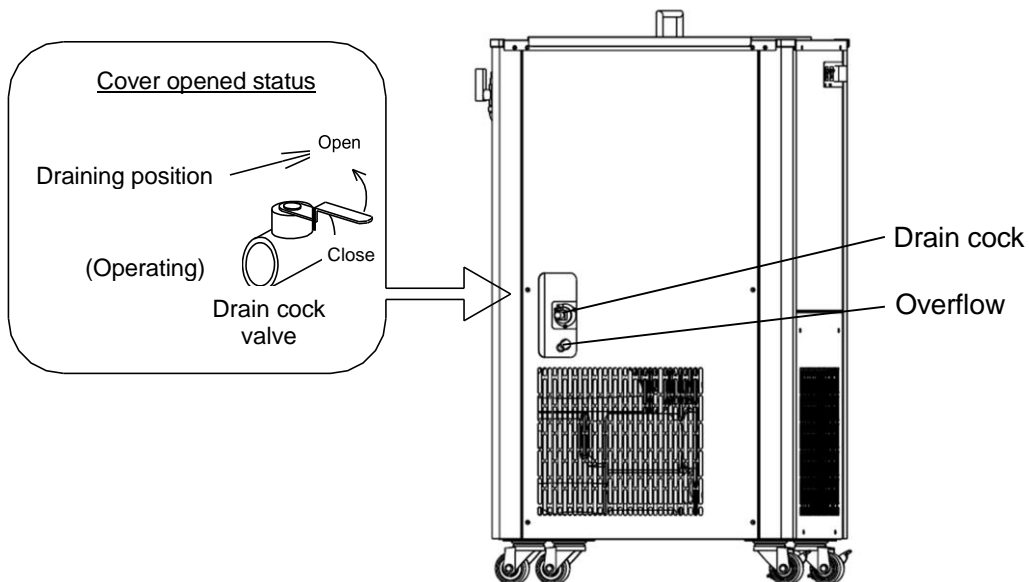

5. Power Plug Connection

- Check the earth leakage breaker, the refrigerator switch and the pump switch are turned "OFF", and plug the power cord in the receptacle.

6. Insert the cooling liquid into the bath

- Remove the cover of the bath, and insert the antifreezing liquid into the bath with its cooling coil hidden. When supplying the liquid, remove the cap of the overflow on the left side surface of the bath without fail, and prepare the pan for the bath.
- With this status, turn on the pump switch, and circulate the liquid. At this time, check that the liquid is circulated with no abnormal noise. There would be the case that the liquid is not circulated because of the remained air in the bath. Turn on and off the pump switch for several times for evacuating the remained air. After completing the evacuation of the remained air, the liquid might be circulated. Even though the liquid is not circulated yet, turn off the power of the refrigerator and pump switch immediately, check the status of the relevant devices referring to Page 24 "In the Event of Failure...". (Keeping the operation of the device without circulating the liquid could cause the malfunction of the circulation pump.)
- After stabilizing the liquid circulation, supply the liquid up to the position where the cooling coil is hidden with the liquid.
- After supplying the liquid, turn OFF the power.
- Cover the bath.

7. Connection of the overflow hose

- I prepare a bat of around 3L separately, and please install it to prevent circulation liquid from overflowing from a water tank by the afflux from the outside connection device at the time of the shutdown.

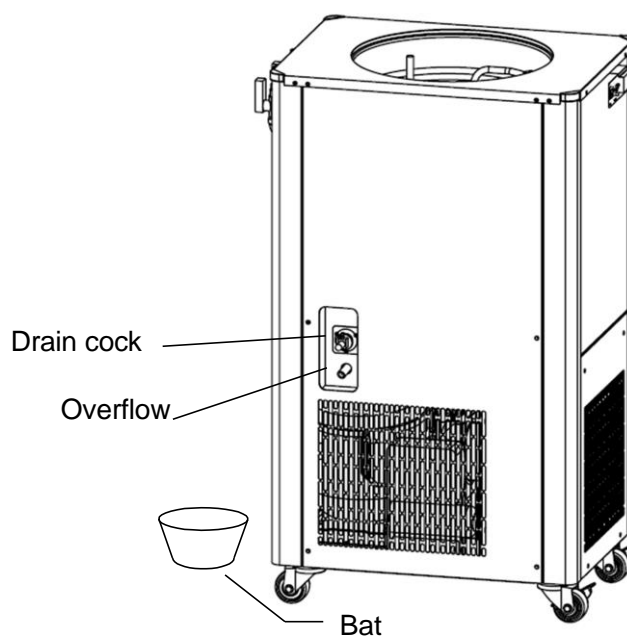

Procedure of Operation

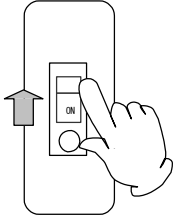
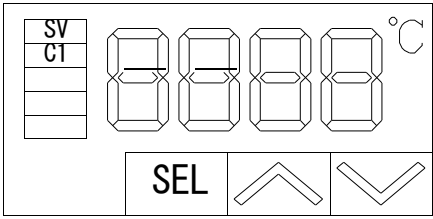
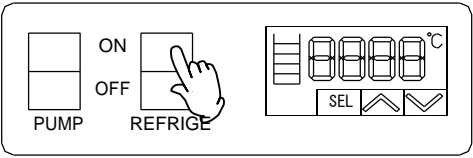
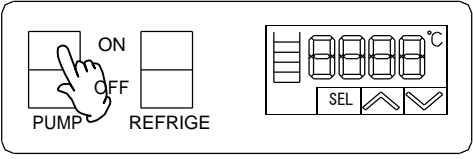
<p>1. Turn "ON" the earth leakage breaker.</p>	
<p>2. Set the temperature. Set the temperature to be applied with the "SEL" key. Pressing the "SEL" key lights on the SV indicating lamp. Set the temperature with "▲,▼" keys, and press the "SEL" key again after checking the setting status of the temperature.</p>	
<p>3. Turning on switch of the refrigerator. After checking the C1 lamp of the temperature controller (control output 1) is turned ON, turn on the switch of the refrigerator. The device starts operation by the actuation of the time after passing about 3 minutes.</p> <p>❖ Note: The lighting on and off status of the "C1" lamp of the temperature controller indicates the performance status of the output contacting point. Since the actual control temperature is controlled by the "ON" and "OFF" of the refrigerator, the time delay between the "C1" lamp motion of the temperature controller and "ON" "OFF" timing of the refrigerator might be occurred. This time delay might be caused by the pre-setting of the 3-minute delay circuit for preventing from the refrigerator malfunction.</p>	
<p>4. Turning on the pump switch. Check that the hose is connected between the circulation port of the main device and cooling device, and that the circulation liquid is filled into the water bath. Then turn on the pump switch. Please open the stop valve discharge and the return at the time of the pump driving by all means.</p>	
<p>5. End of the operation. Turn off the pump, refrigerator switch, and main power switch.</p>	

Heating and cooling curve, cooling capacity curve (reference data)



Regard the data below as reference only because actual result will differ depending on the amount of samples and the environmental temperature.

Measurement conditions (cooling characteristics, freezing retaining capacity)

- Room temp : 20°C
- External load : no load
- Power supply : AC100V
- Frequency:50Hz(cooling characteristics, cooling capacity), 50Hz/60Hz(flow and lift)
- Circulating liquid : Nybrine 60%
- Circulating liquid amount: 14ℓ
- Fixed position: center in the bath
- Lift Calculated as $1.0\text{MPa} = 10.0\text{kg/cm}^2 \cong 100.0\text{m}$

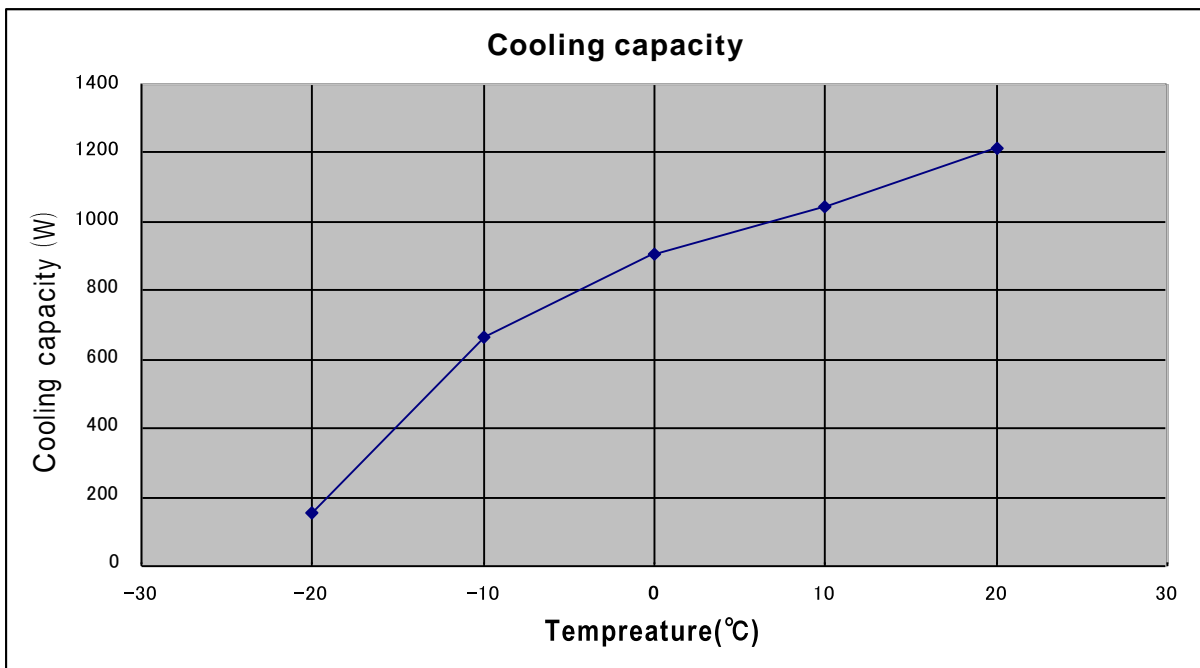
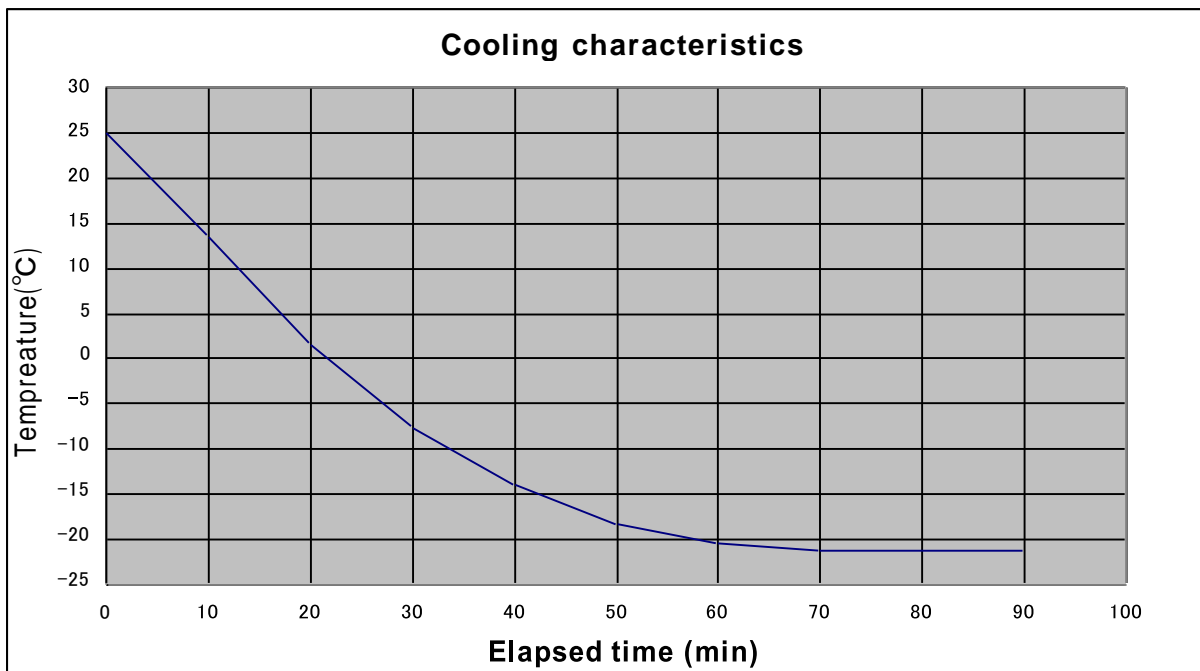

Flow Rate and Head (reference data)

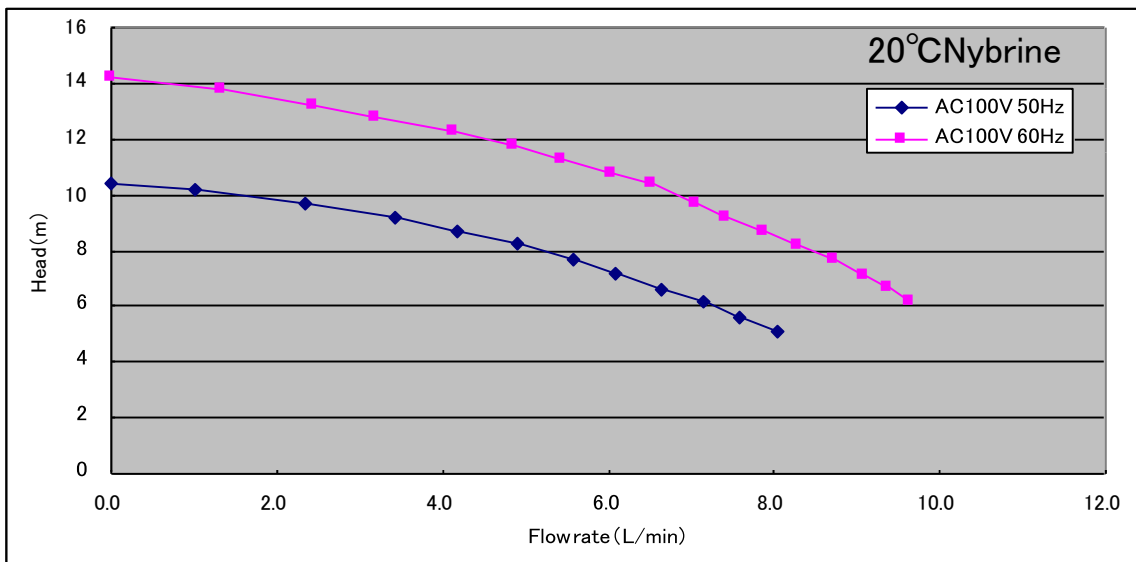
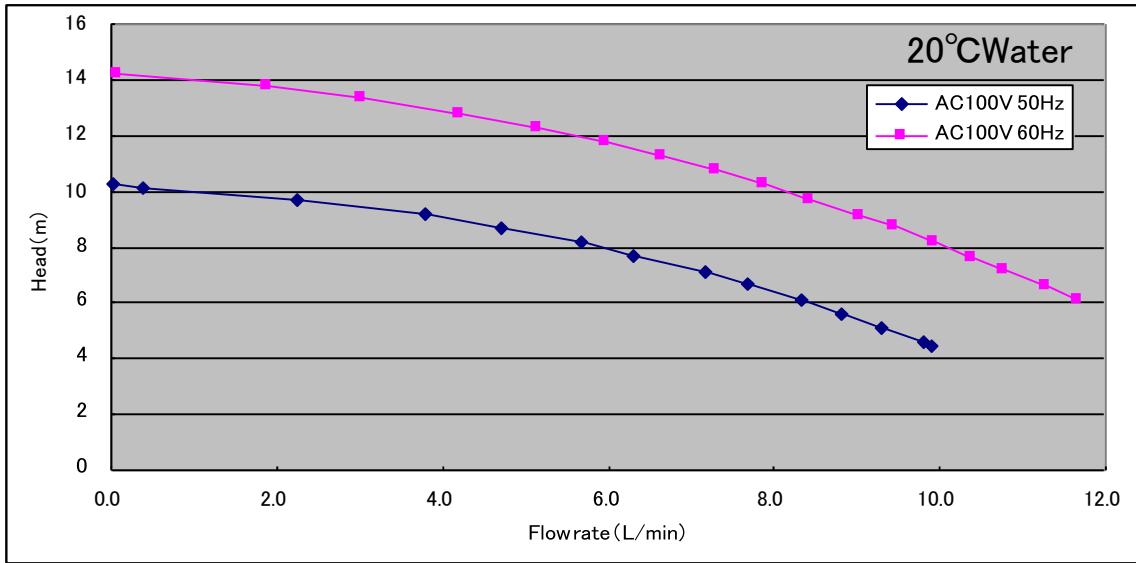

Selecting heat medium for lower temperature (reference data)

You need to use a heat medium for lower temperature when the cooling temperature is set to 10°C or below.

Choose Naiburain® product and its concentration according to 10°C lower than working temperature.

Ethylene glycol

Property	
Boiling point	197.8°C
Coagulation point	-13.0°C
Ignition point	121.0°C
Firing point	410.0°C
SG (at 20°C)	1.1188
SH (at 20°C)	0.561cal/g°C
Evaporative latent heat	191cal/g°C
Viscosity	0.021Pa·s(20.93CP)
Steam Pressure	16.0Pa (0.12mHG)

Ethyl alcohol

Property	
Molecular weight	46.068
Boiling point	78.32°C
Coagulation point	-114.5°C
Ignition point	13°C(closed), 18°C(open) 24.7°C(60% solution,at25°C)
Firing point	439°C
SG (at20°C)	0.7893
SH (at20°C)	0.579cal/g · °C
Viscosity	1.0826cp(at25°C)

Property	Z1,Z1-K		RH		NFP	
	50Wt%	100 Wt%	50Wt%	100 Wt%	50Wt%	100 Wt%
Boiling point (°C)	104	117	105	118	102	107
Specific resistance (Ω · cm at)	625	1250	270	440	530	970
Conductivity(S · m ⁻¹ at 25°C)	0.160	0.080	0.370	0.227	0.189	0.103
Steam pressure (KPa at 20°C)	1.7	0.5	1.7	0.5	2.3	1.3
Freezing point (°C)	-21	-50 or less	-21	-50 or less	-13.5	-50 or less
SG (at20°C)	1.05	1.10	1.07	1.134	1.026	1.048
Viscosity (mPa · s at 20°C)	2.5	9.5	2.5	9.5	2.6	9.4
SH (cal/g at 20°C)	0.850	0.670	0.850	0.670	0.773	0.642

Freezing temp of ethylene glycol

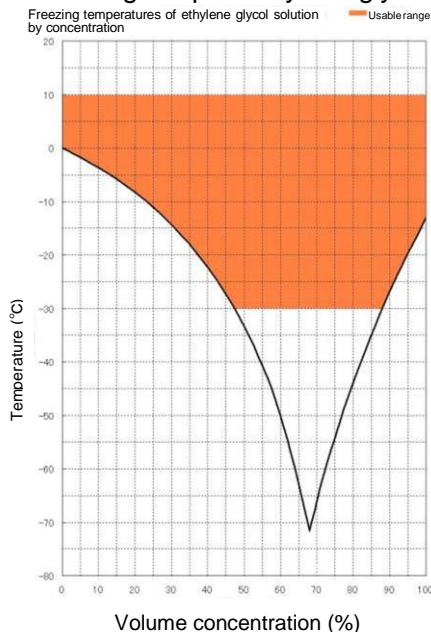

Freezing temp of Nybrine

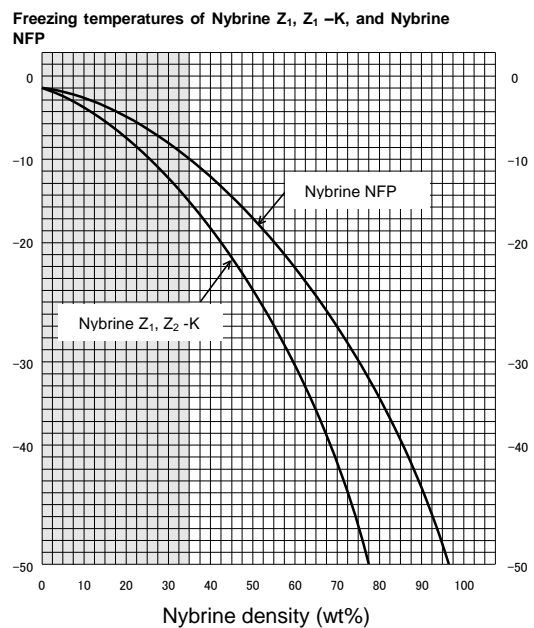

WARNING!

If a problem occurs

-  If smoke or strange odor should come out of this unit for some reason, turn off the power key right away, and then turn off the breaker and the main power. Immediately contact a service technician for inspection. If this procedure is not followed, fire or electrical shock may result. Never perform repair work yourself, since it is dangerous and not recommended.

Measure for flammability and handling of flammable solvent

-  This unit is not designed as the explosion-proof construction. Pay special attention to the handling of the sample to be handled with this unit on the consumption with the explosive material, flammable material, and similar ones. The flammable material may be vaporized by leaving it at the temperature higher than room temperature, and could cause the fire or explosion. When handling such material, provide ventilation with enough before the operation. (Refer to page29 "List of Dangerous Substances".)

CAUTION!

Water bath capacity

-  The water bath capacities of the CF800 type devices are approx. 16 liters. If the liquid is supplied over these capacities, the leakage of the liquid might be occurred.

Do not step on this unit

-  Do not step on this unit. It will cause injury if this unit fall down or break.

Do not put anything on this unit

-  Do not put anything on this unit. It will cause injury if fall.



During a thunder storm

-  During a thunderstorm, turn off the power key immediately, then turn off the circuit breaker and the main power. If this procedure is not followed, fire or electrical shock may be caused.

Countermeasure for stop operation during night or long-term stop

-  In case of stopping operation during night or long-term, toggle the power switch to "OFF".

Circulation pump protection

-  • Never operate the circulation pump with no liquid. Failure to do so could cause the malfunction of the pump.
- If any obstacles are included in the cooling liquid, this obstacle might be caused the breakage of the pump.
-  • In case that the solenoid valve and throttle valve are attached to the circulation path, do not leave the valve in closed or too much throttled statuses for preventing from the pump damage.
- Keep minimum flow rate of circulating solution more than 10% of Pump Max Flow Rate according to Specification Table on P26.

Recovery from a power failure



If the unit was deactivated in the middle of operation due to a power failure and is re-energized, the unit automatically returns to the state just before the power failure and resumes operation. To make manual recovery valid, make necessary settings according to "H06 function 2: Power failure compensation setting" in the "Operation Manual for the Model CR5 Program Controller." If the resumption of operation by automatic recovery is inconvenient, turn off the leakage breaker.

Abnormal refrigerator pressure



If the refrigerator operates in a high-temperature range, the refrigerator overload relay protecting circuit may work to illuminate OVERLOAD lamp deactivate the refrigerator. In this case, reduce thermal load by changing the liquid, or taking other appropriate measures.

About condensation



Condensate may generate depending on the operating conditions or the environment. Wipe any condensate with a dry cloth or a rag.

About the circulating hose



The piping path in the unit employs a silicon hose. Silicon may discolor due to aged degradation. Although it will not adversely affect performance or quality, we recommend replacing hoses at least every two years to assure reliable operation.

When transporting the unit



Do not hold the unit on its side when you lift it for transportation. Observe the installation procedures (P.11~12) when reinstalling the unit.

About replacement of circulating liquid



When replacing circulating liquid, first completely drain liquid remaining in the circulating path if a different type of liquid is to be used.

About circulating liquid



- Choose circulating liquid according to its operating temperature.
Target Temperature more than 10°C : City Water(or soften Industrial Water)
Target Temperature less than 10°C : Nonfreezing Solution(recommend Naiburain solution diluted by City Water)
※Never choose pure water and/or deionized water as circulating liquid.
Make the line up of concentration adjusted Naiburain solution so called Luck-rack Solution as Yamato Products.
Please contact with local dealer or Yamato sales office and ask for Luck-rack Solution.

Product Name	Product Code	Concentration (W t%)	STD Target Temperature	Package Volume (in liters)
Luck-rack Solution: Z16005	756071	60%	-20°C	5L
Luck-rack Solution: Z16010	756072			10L
Luck-rack Solution: Z10005	756073	100%	-30°C	5L
Luck-rack Solution: Z10010	756074			10L
Luck-rack Solution: NFP6005	756075	60%	-10°C	5L
Luck-rack Solution: NFP6010	756076			10L

May cause failure of this Equipment/Unit so that pay attention to notices below.

- May degrade the concentration percentage of nonfreezing solution for many months operation. Check concentration percentage of nonfreezing solution and/or change the whole quantity of nonfreezing solution by every 6(six) months as the standard.
- Change the whole quantity of city water by every 3(three) months as the standard.
- Never choose disqualified water(such as well water etc.), or pure water and deionized water as circulating liquid.
- May not meet with the Equipment/Unit performance because circulating pump will be overworked, if apply high specific gravity and/or high viscosity liquid such as Fluorinert(by 3M) and GALDEN(by Daitoku Tech) etc.
- Never apply following solution to this Equipment/Unit.
 - Corrosive solution, and /or
 - Solution to generate corrosives at heating such as Fluorinert(by 3M) etc.
 - Solution to be harmed human body by absorbing its evaporating gas such as methanol

Check component materials to contact with solution below, choose adequate disinfectant, mix it with circulating solution, and then apply.
(Component materials to contact with solution:
Stainless Steel, Copper w/nickel plated, Silicon Rubber)
- Be careful flammable solution to apply as nonfreezing solution such as ethanol, etc.
 - Ventilate laboratory/room well.
 - Never bring fire and igniting source(static electricity etc.) close to this Equipment/Unit.

About replacement of circulating liquid



Notice at changing from present circulating liquid to any other different kind of it. Must be drained completely circulating liquid remained in its line of this Equipment and then change to new liquid.

Daily Inspection and Maintenance

WARNING!

- Disconnect the power cable from the power source when doing an inspection or maintenance unless needed.
- Perform the daily inspection and maintenance after returning the temperature of this unit to the normal one.
- Do not disassemble this unit.
- Do not touch the cooling fin with bare hands.

CAUTION!

- Use a well-drained soft cloth to wipe dirt on this unit. Do not use benzene, thinner or cleanser for wiping. Do not scrub this unit. Deformation, deterioration or color change may result in.



Monthly maintenance

- Check the earth leakage breaker function.
 1. Connect the power cord.
 2. Turn the breaker on.
 3. Push the red test switch by a ballpoint pen etc.
 4. If there is no problem, the earth leakage breaker will be turned off.

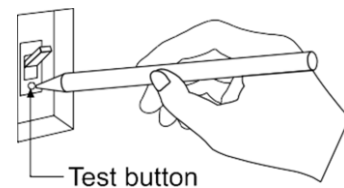

Cleaning of cooling fin

- Clogging of the cooling fin could cause the deterioration of the cooling performance, and also cause the malfunction of the refrigerator. The clogged status differs depending on the surrounding condition or operation time. Clean the cooling fin periodically.
- ❖ Loosen the mounting screws (4 screws) of the ventilation port cover, remove the cover of the ventilation port, and remove the dust attached to the surface of the cover using the vacuum cleaner.
- ❖ After cleaning the cooling fin, attach it in inverse procedure.

 Take care not to crush the fin during cleaning.

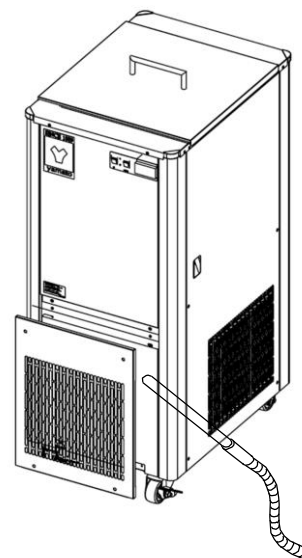

For any questions, contact the dealer who you purchased this unit from, or the nearest sales division in our company.

Daily Inspection and Maintenance

Maintenance of the water bath

Remove foreign substances inside Water Bath as frequently as possible. They may result in circulating pump malfunction if they are left there.

Must wear pair of gloves at maintenance of this Water Bath.

Replacement of hoses

Replace heat insulation hoses by once every 2(two) years as the standard to keep the Equipment/Unit in good condition.

Ask Yamato Scientific Co., Ltd. for replacement.

Changing liquid regularly

Change total circulating liquid by every 3 months for city water and by every 6(six) months for Naiburain® as the standard.

Accumulate fur, alga, and scale in circulating pump so that degrade the Equipment/Unit performance and then may cause failure, if circulating liquid will degrade.

Long storage and disposal

When not using this unit for long term / When disposing

Caution

When the unit is not going to be used for a long time

- Turn the ELB to off and pull out the power cord.
- Drain circulating liquid.

Warning

When you are going to discard the product

- Apply CFC-replacing material as cooling for refrigerator, Ask qualified company to dispose CFC according to CFC Collection Low.
- Do not leave this Equipment/Unit alone where children may and get at it.

Notes about disposition

Always pay attention to the preservation of the global environment.

- We highly recommend taking the unit apart as far as possible for separation or recycling to contribute to the preservation of the global environment. Major components and materials for the unit are as follows:

Component Name	Material
Parts of Main Unit	
Casing	Chromium-free electro galvanized steel plate (SECC) Chemical-proof bake coating
Inner bath	SUS304 stainless steel
Cover	SUS304 stainless steel, Resin
Production plates	Polyester (PET) resin film
Corner	Alkylbenzenesulfid (ABS) resin
Caster	Iron, Steel
Electrical Parts	
Switches, Relays	Composites with resin and others
Power cord & wiring materials and others	Composites with synthetic rubber, copper, nickel and others
Fan motor	Aluminum, Other synthetic
Pump	Composites with iron, copper, resin, ceramic and others
Parts of Refrigeration System	
Compressor	Composites with iron, copper and others
Condenser	Iron, Copper, Aluminum
Cooling device	Nickel plated copper
Piping parts	Composites with copper and others
Parts of Water Path	
Drain, overflow and inner piping	Silicon rubber
Connecting parts	Resin
Insulating hose	Neoprene
Sealed Cooling Medium for Refrigerator	
Cooling medium	R404A 530g(Ask the specialist for the dealing of cooling medium)

Trouble Shooting

Condition	Possible Causes
Refrigerator does not start when turning on the power switch.	<ul style="list-style-type: none"> • Power plug is not connected to the receptacle correctly. • Power failure. • Earth leakage breaker is turned to "OFF"
Not fallen the temperature.	<ul style="list-style-type: none"> • The setting is high than the in-bath temperature. • The condenser filter at the lower front of the main body is dirty. • The condenser fins are clogged. • Heat load of circulating liquid is too large. • The environmental temperature is high. • The Suction hole is blocked.
Refrigerator cannot be restarted.	<ul style="list-style-type: none"> • The refrigerator is in overloaded. Turn off the power of the refrigerator immediately, keep the temperature, and turn on the power of the refrigerator after a while.
The liquid is not circulated.	<ul style="list-style-type: none"> • The circulation path is closed or throttled too narrow at any point. • The argillaceous or specific gravity of the cooling liquid appropriate.

Error Display

Error Sign	Cause	Remedy
UUUU	<ul style="list-style-type: none"> ▪ Sensor disconnection ▪ Coolant temperature exceeded 35 degrees Celsius 	<ul style="list-style-type: none"> ▪ Check the sensor connection. ▪ Please do below coolant temperature 35 degrees Celsius
FALR	<ul style="list-style-type: none"> ▪ Malfunction of the temperature controller 	<ul style="list-style-type: none"> ▪ Stop operation. Turn off the power immediately,

In the case if the error other than listed above occurred, turn off the power switch and primary power source immediately. Contact the shop of your purchase or nearest Yamato Scientific Service Office.

In Case of Request for Repair

If the failure occurs, stop the operation, turn OFF the power switch, and unplug the power plug. Please contact the sales agency that this unit was purchased, or the Yamato Scientific's sales office.

< Check following items before contact >

- ◆ Model Name of Product
 - ◆ Production Number
 - ◆ Purchase Date
- } See the production plate attached to this unit.
- ◆ About Trouble (in detail as possible)

Minimum Retention Period of Performance Parts for Repair

The minimum retention period of performance parts for repair of this unit is 7 years after discontinuance of this unit.

The "performance part for repair" is the part that is required to maintain this unit.

Model		CF800		
Circulation system		Closed circulation		
Operational ambient temperature		5 to 35°C		
Performance※1	Temperature setting range		-20 to room temp	
	Refrigerator (AC100V 50Hz)		1050W · at10°C	
			910W · at0°C	
			670W · at-10°C	
	Temperature adjustment accuracy Temperature change		JTM K05 ±1.5°C at10°C JIS ±1.5°C at10°C	
Circulation capability ※3	Max. flow rate	50Hz: Approx. 16.9L/min 60Hz: Approx. 19.6L/min		
	Rising range	10.3m/14.3m		
Configuration	Temperature control system		Refrigerator ON/OFF	
	Temperature sensor		T thermo couple (with SUS protection tube)	
	Temperature setting /display system		Digital setting/display	
	Refrigerator		Air cooling, 600W	
	Cooling medium		R404a 530g	
	Cooling coil		Nickel plated copper	
	External circulation nozzle		Outer diameter: 10.5mm (both discharge and return) with hose nipple	
	Circulation pump		Magnetic pump 65/65W	
	Bath	Material	SUS304	
		Dimensions	φ 300×235mm	
Capacity		Approx. 16L(liquid quantity: 14L)		
Safety devices		Electric leakage breaker, Overload relay keeping circuit for refrigerator, Pump thermal protector, Delay timer for refrigerator protection		
Other functions		Overflow, Drainage cook Service electrical outlet (AC100V 5AAspirator unit power supply use)		
Standards	External dimensions (W×D×H mm) ※2		355×480×1060	
	Weight		Approx. 80Kg	
	Power supply		115V AC, 50/60Hz, 12.5A(I include service electrical outlet AC115V 3A)	
Accessories		Instruction manualx1, warranty cardx1, Top cover, 0.5-meter-long drain hosex1, 3-meter-long circulation hosex1 Wire clampx2		

※1 At room temperature: 23°C,

※2 The outer dimensions do not included protrusions.

※3 heat medium: water.

CF800

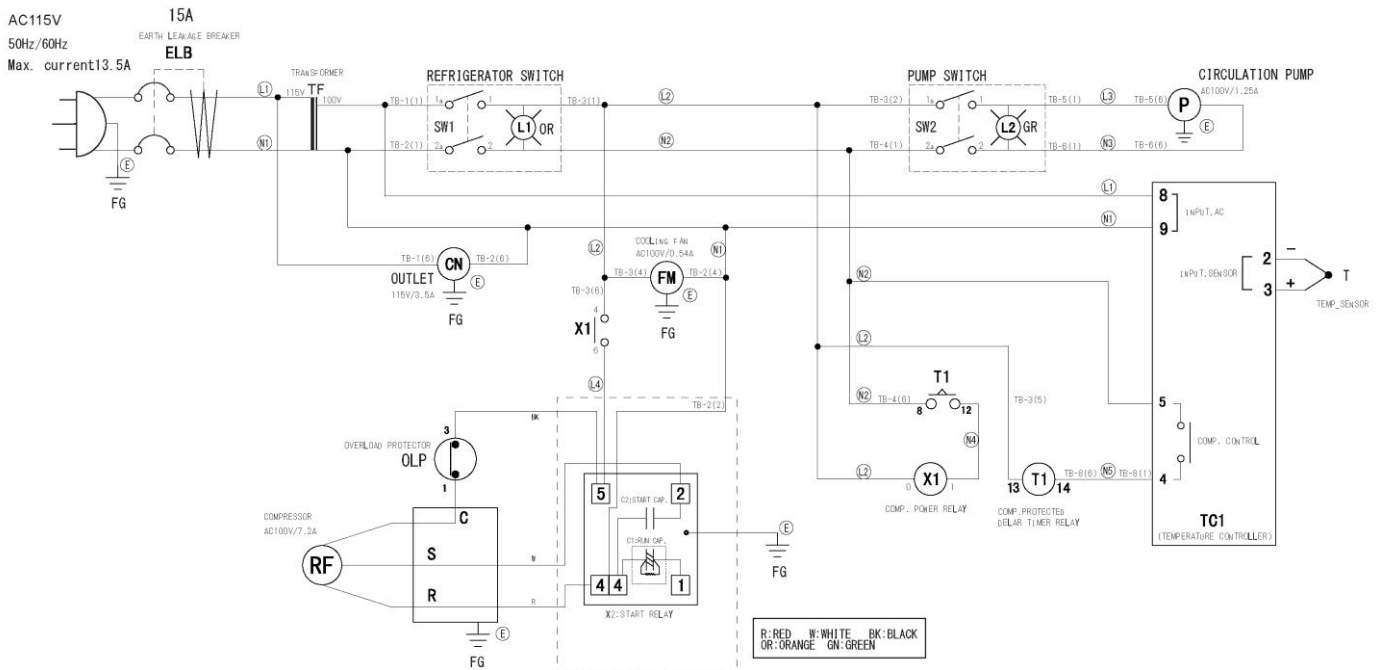

Symbol	Part name	Symbol	Part name
ELB	Earth leakage breaker	T1	COMP. protector, Delay timer relay
TC1	Temperature controller	C1	RUN CAP.
S1	Refrigerator switch	C2	START CAP.
S2	Pump switch	FM	Cooling fan
X1	COMP. power relay	RF	Compressor
X2	START RELAY	P	Circulation pump
K	TEMP. sensor	OLP	Overload protector
CN	Outlet	TF	Transformer

Replacement Parts Table

Part Name	Code No.	Specification	Manufacturer
Drain hoses	3040010002	$\phi 9 \times \phi 12 \times 0.5\text{m}$	Yamato Scientific
Circulation hoses	3040000001	$\phi 9 \times \phi 13 \times 3\text{m}$	Yamato Scientific
Filter	CF80043030	CF800-43030	Yamato Scientific

List of Dangerous Substances



Never use an explosive substance a flammable substance or a substance containing them for this device.

Explosive substance	① Nitroglycol, glycerine trinitrate, cellulose nitrate and other explosive nitrate esters	
	② Trinitrobenzen, trinitrotoluene, picric acid and other explosive nitro compounds	
	③ Acetyl hydroperoxide, methyl ethyl ketone peroxide, benzoyl peroxide and other organic peroxides	
	④ Metallic azide, including sodium azide, etc.	
Flammable substances	Explosive substances ① Metal "lithium" ② metal "potassium" ③ metal "natrium" ④ yellow phosphorus ⑤ phosphorus sulfide ⑥ red phosphorus ⑦ phosphorus sulfide ⑧ celluloids, calcium carbide (a.k.a, carbide) ⑨ lime phosphide ⑩ magnesium powder ⑪ aluminum powder ⑫ metal powder other than magnesium and aluminum powder ⑬ sodium dithionous acid (a.k.a., hydrosulphite)	
	Oxidizing substances	① Potassium chlorate, sodium chlorate, ammonium chlorate, and other chlorates
		② Potassium perchlorate, sodium perchlorate, ammonium perchlorate, and other perchlorates
		③ Potassium peroxide, sodium peroxide, barium peroxide, and other inorganic peroxides
		④ Potassium nitrate, sodium nitrate, ammonium nitrate, and other nitrates
		⑤ Sodium chlorite and other chlorites
		⑥ Calcium hypochlorite and other hypochlorites
	Flammable substances	① Ethyl ether, gasoline, acetaldehyde, propylene chloride, carbon disulfide, and other substances with ignition point at a degree 30 or more degrees below zero.
		② n-hexane, ethylene oxide, acetone, benzene, methyl ethyl ketone and other substances with ignition point between 30 degrees below zero and less than zero.
		③ Methanol, ethanol, xylene, pentyl n-acetate, (a.k.a.amyl n-acetate) and other substances with ignition point between zero and less than 30 degrees.
④ Kerosene, light oil, terebinth oil, isopenthyl alcohol(a.k.a. isoamyl alcohol), acetic acid and other substances with ignition point between 30 degrees and less than 65 degrees.		
Combustible gas	Hydrogen, acetylene, ethylene, methane, ethane, propane, butane and other gases combustible at 15°C at one air pressure.	

Excerpt from Table 1, Hazardous Substances, of the Cabinet Order of the Occupational Safety and Health Law (substances related to Articles 1, 6, and 9)

Standard installation manual

※Install the unit according to the items below. (Confirm optional or special specifications.)

Model	Serial number	Date	Inst. Manager(company name)	Inst. manager	Judge

No.	Item	Implementation method	TOC No. Ref. column of manual	Judge
Specifications				
1	Accessories	Check items based on the accessories column	Specification column P.25	
2	Installation	<ul style="list-style-type: none"> Visual check of the environmental conditions Caution : Surrounding environment	Before operating the unit - Requirements for installation P.5	
		<ul style="list-style-type: none"> Securing a space 	Installation method P.11~	
		<ul style="list-style-type: none"> Add water in the water bath. 	12	
Operation related matters				
1	Source voltage	<ul style="list-style-type: none"> Measure customer side voltage (at an outlet) with a tester. Measurement of an operating voltage (must meet the standard) Caution : Use a product that comply with the standard for installing to a plug or a	Before operating the unit <ul style="list-style-type: none"> Be sure to connect the earth... P.5 P.6 Connect the power supply... Specifications P.25 Standard—power supply 	
2	Starting operation	<ul style="list-style-type: none"> Start operation Circulating liquid must be circulating. Set to 20 °C and check the stability. Check : There is no water leak.	Installation method... P.11~ How to operate 12 <ul style="list-style-type: none"> Operating procedures P.13 	
Description				
1	Description of operation	Explain operation of each part to the customer as per the instructions.	Operating procedures P.13 <ul style="list-style-type: none"> Operating method P.2 Safety precautions ~P.28 List of dangerous substances 	
2	Error codes	Explain error codes and how to release to the customer as per the instructions.	When a trouble occurs ~ After sales service and warranty P.23~ 24	
3	Maintenance and inspection	Explain operation of each part to the customer as per the instructions.	Maintenance procedures <ul style="list-style-type: none"> Daily inspection/ maintenance P.20 	
4	Matters to note on completion of installation	<ul style="list-style-type: none"> Note the installation date and the manager on the nameplate. Note necessary matters in the warranty card and hand it to the customer. Explain the after sales 	After sales service and warranty P.24	

Responsibility

Please follow the instructions in this document when using this unit. Yamato Scientific has no responsibility for the accidents or breakdown of device if it is used with a failure to comply. Never conduct what this document forbids. Unexpected accidents or breakdown may result in.

Note

- ◆ The contents of this document may be changed in future without notice.
- ◆ Any books with missing pages or disorderly binding may be replaced.

Instruction Manual for

**Neo-cool Circulator
Model CF800**

Second Edition May 7, 2013

Revision October 28, 2015

Yamato Scientific America, Inc.

925 Walsh Avenue, Santa Clara,

CA 95050, U.S.A,

http://www.yamato*usa.com

Toll Free: 1-800-2-YAMATO(1-800-292-6286)