



Technology for Vacuum Systems

Instructions for use



DCP 3000

Vacuum gauge

Dear customer,

Your VACUUBRAND vacuum gauges are designed to provide you with many years of trouble-free service with optimal performance. Our many years of practical experience allow us to provide a wealth of application and safety information. Please read these instructions for use before the initial operation of your vacuum gauge.

VACUUBRAND vacuum gauges combine our many years of experience in design, construction and practical operation, with the latest developments in material and manufacturing technology.

Our quality maxim is the "zero defect" principle:

Every vacuum gauge, before leaving our factory, is tested intensively, including an endurance run. Any faults, even those which occur rarely, are identified and can be eliminated immediately.

After completion of the endurance run, every vacuum gauge is tested, and must achieve specifications before shipment.

We are committed to providing our customers only vacuum gauges that meet this high quality standard.

While our vacuum gauges cannot eliminate all of your work, we design, manufacture and test them to ensure that they will be an effective and trouble-free tool to assist you in that work.

Yours,

VACUUBRAND GMBH + CO KG

After sales service:

Contact your local dealer or call +49 9342 808-5500

Trademark index:

VACUU•LAN® (US-Reg.No 3,704,401), VACUU•BUS®, VACUU•CONTROL®, Peltronic®, VARIO® (US-Reg.No 3,833,788), VACUUBRAND® (US-Reg.No 3,733,388) and also the shown company logos are registered trademarks of VACUUBRAND GMBH + CO KG in Germany and/or other countries.

DE

Achtung: Die vorliegende Betriebsanleitung ist nicht in allen EU-Sprachen verfügbar. Der Anwender darf die beschriebenen Geräte nur dann in Betrieb nehmen, wenn er die vorliegende Anleitung versteht oder eine fachlich korrekte Übersetzung der vollständigen Anleitung vorliegen hat. Die Betriebsanleitung muss vor Inbetriebnahme der Geräte vollständig gelesen und verstanden werden, und alle geforderten Maßnahmen müssen eingehalten werden.  "Sicherheitshinweise für Vakuumgeräte"

EN

Attention: This manual is not available in all languages of the EU. The user must not operate the device if he does not understand this manual. In this case a technically correct translation of the complete manual has to be available. The manual must be completely read and understood before operation of the device and all required measures must be applied.  "Safety instructions for vacuum equipment"

FR

Attention: Le mode d'emploi présent n'est pas disponible dans toutes les langues d'Union Européenne. L'utilisateur ne doit mettre le dispositif en marche que s'il comprend le mode d'emploi présent ou si une traduction complète et correcte du mode d'emploi est sous ses yeux. Le dispositif ne doit pas être mis en marche avant que le mode d'emploi ait été lu et compris complètement et seulement si le mode d'emploi est observé et tous les mesures demandées sont prises.

 «Avis de sécurité pour des dispositifs à vide»

BG

Внимание: Тези инструкции не са преведени на всички езици от ЕО. Потребителят не бива да работи с уреда, ако не разбира инструкциите за ползване. В този случай е необходимо да бъде предоставен пълен технически превод на инструкциите за ползване. Преди работа с уреда е задължително потребителят да прочете изцяло инструкциите за работа.

 "Указания за безопасност за вакуумни уреди"

CN

注意：该操作手册不提供所有的语言版本。操作者在没有理解手册之前，不能操作该设备。在这种情况下，需要有一个整个操作手册技术上正确的翻译。在操作该设备前，必须完全阅读并理解该操作手册，必须实施所有需要的测量。

 真空设备的安全信息

CZ

Upozornění :Tento návod k použití není k dispozici ve všech jazycích Evropské unie. Uživatel není oprávněn požit přístroj pokud nerozumí tomuto návodu. V takovém případě je nutno zajistit technicky korektní překlad manuálu do češtiny. Návod musí být uživatelem prostudován a uživatel mu musí plně porozumět před tím než začne přístroj používat. Uživatel musí dodržet všechna příslušná a požadovaná opatření.  "Bezpečnostní upozornění pro vakuové přístroje".

DA

Bemærk: Denne manual foreligger ikke på alle EU sprog. Brugeren må ikke betjene apparatet hvis manualen ikke er forstået. I det tilfælde skal en teknisk korrekt oversættelse af hele manual stilles til rådighed. Manual skal være gennemlæst og forstået før apparatet betjenes og alle nødvendige forholdsregler skal tages.

 »Sikkerhedsregler for vakuumdstyr«

EE

Tähelepanu! Käesolev kasutusjuhend ei ole kõigis EL keeltes saadaval. Kasutaja ei tohi seadet käsitseda, kui ta ei saa kasutusjuhendist aru. Sel juhul peab saadaval olema kogu kasutusjuhendi tehniliselt korrektne tõlge. Enne seadme kasutamist tuleb kogu juhend läbi lugeda, see peab olema arusaadav ning kõik nõutud meetmed peavad olema rakendatud.  "Ohutusnõuded vaakumseadmetele"

ES

Atención: Este manual no está disponible en todos los idiomas de UE. El usuario no debe manejar el instrumento si no entiende este manual. En este caso se debe disponer de una traducción técnicamente correcta del manual completo. El manual debe ser leído y entendido completamente y deben aplicarse todas las medidas de seguridad antes de manejar el instrumento.  "Notas sobre la seguridad para equipos de vacío"

FI

Huomio: Tämä käyttöohje ei ole saatavilla kaikilla EU: n kielillä. Käyttäjä ei saa käyttää laitetta, jos hän ei ymmärrä tätä ohjekirjaa. Tässä tapauksessa on saatavilla oltava teknisesti oikein tehty ja täydellinen ohjekirjan käännös. Ennen laitteen käyttöä on ohjekirja luettava ja ymmärrettävä kokonaan sekä suoritettava kaikki tarvittavat valmistelut ja muut toimenpiteet.  "Vakuumlaitteen turvallisuustiedot"

GR

Προσοχή! : Οι οδηγίες αυτές δεν είναι διαθέσιμες σε όλες τις γλώσσες της Ευρωπαϊκής Ένωσης. Ο χρήστης δεν πρέπει να θέσει σε λειτουργία την συσκευή αν δεν κατανοήσει πλήρως τις οδηγίες αυτές. Σε τέτοια περίπτωση ο χρήστης πρέπει να προμηθευτεί ακριβή μετάφραση του βιβλίου οδηγιών. Ο χρήστης πρέπει να διαβάσει και να κατανοήσει πλήρως τις οδηγίες χρήσης και να λάβει όλα τα απαραίτητα μέτρα πριν θέσει σε λειτουργία την συσκευή.  "Υποδείξεις ασφάλειας για αντλίες κενού"

HR

Pažnja: ove upute ne postoje na svim jezicima Europske Unije. Korisnik nemora raditi sa aparatom ako ne razumije ove upute. U tom slučaju tehnicki ispravni prijevod cijelih uputstava mora biti na raspolaganju. Uputstva moraju biti cijela procitana i razumljiva prije rada sa aparatom i sve zahtijevane mjere moraju biti primjenjene.

 "Sigurnosne napomene za vakuumske uređaje"

HU

Figyelem! Ez a kezelési utasítás nem áll rendelkezésre az EU összes nyelvén. Ha a felhasználó nem érti jelen használati utasítás szövegét, nem üzemeltetheti a készüléket. Ez esetben a teljes gépkönyv fordításáról gondoskodni kell. Üzembe helyezés előtt a kezelőnek végig kell olvasnia, meg kell értenie azt, továbbá az üzemeltetéshez szükséges összes mérést el kell végeznie.  "A vákuum-készülékekkel kapcsolatos biztonsági tudnivalók"

IT

Attenzione: Questo manuale non è disponibile in tutte le lingue della Comunità Europea (CE). L'utente non deve operare con lo strumento se non comprende questo manuale. In questo caso deve essere resa disponibile una traduzione tecnicamente corretta del manuale completo. Il manuale deve essere completamente letto e compreso prima di operare con lo strumento e devono essere applicati tutti gli accorgimenti richiesti.  "Istruzioni di sicurezza per apparecchi a vuoto"

JP

注意：この取扱説明書はすべての言語で利用可能ではありません。もしこの取扱説明書を理解できないならば、ユーザーは装置を操作してはなりません。この場合、技術的に正しい翻訳がなされた完全なマニュアルを用意しなければなりません。装置を作動する前にマニュアルを完全に読み、そして理解されなくてはなりません。そして、すべての要求される対策を講じなければなりません。

 真空装置を安全に取り扱うために

KR

주의: 이 매뉴얼은 모든 언어로 번역되지 않습니다. 만약 이 매뉴얼의 내용을 충분히 인지하지 못했다면 기기를 작동하지 마십시오. 매뉴얼의 내용을 기술적으로 정확하게 번역한 경우에 이용하십시오. 기기를 사용하기 전에 이 매뉴얼을 충분히 읽고 이해하고 모든 요구되는 사항들을 적용해야 합니다.

 진공 장비에 대한 안전 정보

LT

Dėmesio: šis vadovas nėra pateikiamas visomis ES kalbomis. Naudotojui draudžiama eksploatuoti įtaisą, jeigu jis nesupranta šio vadovo. Tokiu atveju reikia turėti viso vadovo techniškai taisyklingą vertimą. Vadovą būtina visą perskaityti ir suprasti pateikiamas instrukcijas prieš pradėdant eksploatuoti įtaisą, bei imtis visų reikiamų priemonių.  "Vakuuminės įrangos saugos informacija"

LV

Uzmanību: Lietotāja instrukcija nav pieejama visās ES valodās. Lietotājs nedrīkst lietot iekārtu, ja viņš nesaprot lietotāja instrukcijā rakstīto. Šādā gadījumā, ir nepieciešams nodrošināt tehniski pareizu visas lietotāja instrukcijas tulkojumu. Pirms sākt lietot iekārtu, un, lai izpildītu visas nepieciešamās prasības, iekārtas lietotāja instrukcija ir pilnībā jāizlasa un jāsaprot.  "Vakuuma iekārtu drošības noteikumi"

NL

Attentie: Deze gebruiksaanwijzing is niet in alle talen van de EU verkrijgbaar. De gebruiker moet niet met dit apparaat gaan werken als voor hem/haar de gebruiksaanwijzing niet voldoende duidelijk is. Bij gebruik van deze apparatuur is het noodzakelijk een technisch correcte vertaling van de complete gebruiksaanwijzing te hebben. Voor het in gebruik nemen van het apparaat moet de gebruiksaanwijzing volledig gelezen en duidelijk zijn en dienen alle benodigde maatregelen te zijn genomen.  "Veiligheidsvoorschriften voor vacuümapparaten"

PL

Uwaga!! Ta instrukcja nie jest dostępna we wszystkich językach Unii Europejskiej. Użytkownik nie może rozpocząć pracy z urządzeniem dopóki nie przeczytał instrukcji i nie jest pewien wszystkich informacji w niej zawartych. Instrukcja musi być w całości przeczytana i zrozumiana przed podjęciem pracy z urządzeniem oraz należy podjąć wszystkie niezbędne kroki związane z prawidłowym użytkowaniem.

 "Wskazówki bezpieczeństwa do urządzeń próżniowych"

PT

Atenção: Este manual não está disponível em todas as línguas da UE. O usuário não deve utilizar o dispositivo, se não entender este manual. Neste caso, uma tradução tecnicamente correta do manual completo tem de estar disponível. O manual deve ser lido e entendido completamente antes da utilização do equipamento e todas as medidas necessárias devem ser aplicadas.  "Informação de Segurança para Equipamento que funciona a Vácuo"

RO

Atentie: Acest manual nu este disponibil in toate limbile EU. Utilizatorul nu trebuie sa lucreze cu aparatul daca nu intelege manualul. Astfel, va fi disponibile o traducere corecta si completa a manualului. Manualul trebuie citit si inteles in intregime inainte de a lucra cu aparatul si a luat toate masurile care se impun.

 "Instrucțiuni de siguranță pentru aparatele de vidare"

RU

Внимание: Эта инструкция по эксплуатации не имеется на всех языках. Потребителю не дозволено эксплуатировать данный прибор, если он не понимает эту инструкцию. В этом случае нужен технически правильный перевод полной инструкции. Прежде чем использовать этот прибор, необходимо полностью прочитать и понять эту инструкцию и принять все необходимые меры.  "Указания по технике безопасности при работе с вакуумными устройствами"

SE

Varning: Denna instruktion är inte tillgänglig på alla språk inom EU. Användaren får inte starta utrustningen om hon/han inte förstår denna instruktion. Om så är fallet måste en tekniskt korrekt instruktion göras tillgänglig. Instruktionen måste läsas och förstås helt före utrustningen tas i drift och nödvändiga åtgärder göres.

 "Säkerhetsinformation för vakuumutrustning"

SI

Pozor: Ta navodila niso na voljo v vseh jezikih EU. Uporabnik ne sme upravljati z napravo, če ne razume teh navodil. V primeru nerazumljivosti mora biti na voljo tehnično pravilen prevod. Navodila se morajo prebrati in razumeti pred uporaba naprave, opravljene pa moraja biti tudi vse potrebne meritve.

 "Varnostni nasveti za vakuumske naprave"

SK

Upozornenie: Tento manuál nie je k dispozícii vo všetkých jazykoch EÚ. Užívateľ nesmie obsluhovať zariadenie, pokiaľ nerozumie tomuto manuálu. V takomto prípade musí byť k dispozícii technicky správny preklad celého manuálu. Pred obsluhou zariadenia je potrebné si prečítať celý manuál a porozumieť mu, a musia byť prijaté všetky opatrenia.  "Bezpečnostné pokyny pre vákuové zariadenia"

TR

Dikkat : Bu kullanım kitabı, tüm dillerde mevcut değildir. Kullanıcı, bu kullanım kitabını anlayamadıysa cihazı çalıştırmamalıdır. Bu durumda, komple kullanım kitabının, teknik olarak düzgün çevirisinin bulunması gerekir. Cihazın çalıştırılmasından önce kullanım kitabının komple okunması ve anlaşılması ve tüm gerekli ölçümlerin uygulanması gerekir.  "Vakumlu cihazlar için güvenlik uyarıları"

Reset / Language selection

1 switch off



2 press both ↓ ↓

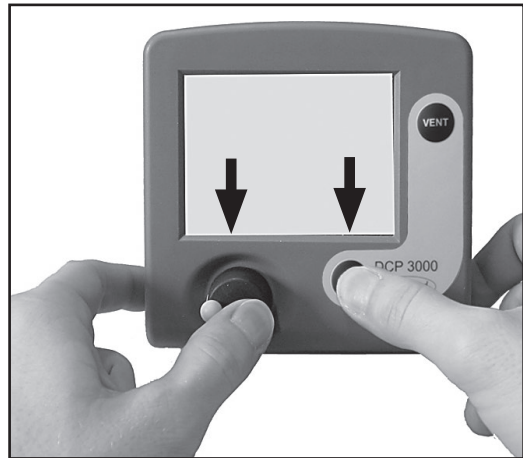

3 turn ↺ ↻



4 press ↓



Contents

Reset / Language selection	8
Safety information!	11
Important information!	11
General information	13
Intended use.....	13
Setting up and installing the equipment	14
Ambient conditions	15
Operating conditions	16
Safety during operation	17
Maintenance and repair.....	18
⊕ Important information: Equipment marking (ATEX).....	19
Technical data	21
Technical data of display unit	21
Technical data of pressure transducers.....	22
Technical data of power supply	23
Wetted parts	24
Abbreviations.....	24
Use and operation	25
Assembling the country-specific power plug	25
Display and symbols	25
Changing the vacuum connector at pressure transducer VSK 3000	29
Notes on operation	30
Menu guide.....	34
Configuration	36
Connecting several pressure transducers.....	38
Manual switching between pressure transducers	38
Automatic switching between pressure transducers VSK 3000 and VSP 3000	39
Measuring differential pressure	39
Reconfiguring the pressure transducer VSP 3000 or VSK 3000	40
Setpoints	42
Configuring valves or digital I/O interfaces for operation with setpoints	43
Interface parameters	44
Setting of the interface	44

Notes concerning the data logger function (recording and sending of data).....	45
Read commands	47
Write commands	49
Troubleshooting	50
Accessories	52
Cleaning the pressure transducer	53
Calibration in the factory	54
Readjustment of VSK 3000	55
Readjustment of VSP 3000	57
Repair - Maintenance - Return - Calibration	59
Warranty	61
Health and safety clearance form	62
EC Declaration of Conformity	63

Safety information!

Important information!

WARNING

- ☞ Keep this manual complete and accessible to personnel at all times!
- ☞ Read this manual carefully before installing or operating the equipment. Observe the instructions contained in this manual.

- ☞ Do not modify the equipment without authorization.

NOTICE

This manual is an integral part of the equipment described therein. It describes the safe and proper use of the vacuum gauge.

Make operating personnel aware of dangers arising from the processed substances.

VACUUBRAND disclaims any liability for inappropriate use of this equipment and for damage from failure to follow instructions contained in this manual.

This manual is only to be used and distributed in its complete and original form. It is strictly the users' responsibility to check carefully the validity of this manual with respect to his product.

Manual-no.: 999162/ 04/14/2016

The following signal word panels and safety symbols are used throughout this manual:



This is the safety alert symbol. It is used to alert you to potential personal injury hazards. Obey all safety messages that follow this symbol to avoid possible injury and death.



➔ DANGER indicates a hazardous situation which, if not avoided, will result in death or serious injury.



☞ WARNING indicates a hazardous situation which, if not avoided, could result in death or serious injury.



• CAUTION indicates a hazardous situation which, if not avoided, could result in minor or moderate injury.



NOTICE is used to address practices not related to personal injury.



Disconnect equipment from AC power.



Dispose of electronic equipment according to regulations.

Formatting used in this manual:

Note: The signal word panels in all sections of this manual always refer to all paragraphs of the same format (➔ / ☞ / • / plain text) following each signal word panel.

The document "Safety information for vacuum equipment" is part of this manual! Read the "Safety information for vacuum equipment" and observe the instructions contained therein!

General information

To operate the vacuum gauge DCP 3000, at least one external pressure transducer (VSK 3000 or VSP 3000 or MPT 100) is required!

NOTICE

Remove all packing material from the packing box. Remove the product from its packing-box and retain all packaging until the equipment is inspected and tested. Inspect the equipment promptly and carefully.

If the equipment is damaged, notify the supplier and the carrier in writing within three days. Retain all packing material for inspection. State the item number of the product together with the order number and the supplier's invoice number. Failure to check and give notice of damage will void any and all warranty claims for those deficiencies.

Store the equipment in dry and non-corrosive conditions (see also "Technical data", pg. 21) if the equipment is not used immediately.

WARNING

☞ **Do not use any damaged equipment.**

Intended use

WARNING

☞ Ensure that the individual components are only connected, combined and operated according to their design and as indicated in the instructions for use. Use only **original manufacturer's spare parts and accessories**. Otherwise the safety and performance of the equipment, as well as the electromagnetic compatibility of the equipment might be reduced.

The CE mark or the cTÜVus mark may be voided if not using original manufacturer's spare parts.

☞ Comply with all notes on correct vacuum and electrical connections; see section "Use and operation", pg. 25.

- ☞ The equipment is designed for operation at **ambient temperatures and gas temperatures** at the pressure transducer between +50°F and +104°F (+10°C and +40°C), or for short periods up to +176°F (+80°C) at the pressure transducer (gas temperature). Periodically check maximum temperatures if installing the equipment in a cabinet or a housing. Make sure ventilation is adequate to maintain recommended operating temperature. Install an external automatic ventilation system if necessary. If processing hot gases, make sure that the maximum permitted gas temperature at the pressure transducer is not exceeded (see “Technical data”, pg. 21).

CAUTION

- Ensure that the wetted parts are chemically resistant to the processed substances prior to operation.

NOTICE

Use the equipment **only as intended**, that is, for measurement of vacuum in vessels designed for that purpose. Any other use will automatically invalidate all warranty and liability claims.

Remain aware of safety and risks.

Setting up and installing the equipment

WARNING

- ☞ Do not permit any **uncontrolled pressurizing** (e.g., make sure that pipelines cannot become blocked) to avoid a **risk of bursting!**
- ☞ Keep the VACUU•BUS cables away from heated surfaces.

CAUTION

- Comply with **maximum permissible pressures** at the pressure transducer. See section “Technical data”, pg. 21.
- Connect hoses gas tight at the pressure transducer.
- Secure hoses at hose nozzles (e.g., with hose clamp) to prevent their accidental slipping. Ensure the stability of hose connections.

- Check the power source and the equipment's rating plate to be sure that the power source and the equipment match in voltage, phase, and frequency.
- When working with residues, aggressive or condensable media, install a gas washing bottle if necessary.

NOTICE

The vacuum gauge is equipped with a short-circuit-proof wide-range power supply with an integrated overload protection.

Assemble and lock the suitable power plug (included in shipment) to the wall power supply prior to use.

Avoid high heat supply (e.g., due to hot process gases). Connect the pressure transducer to the vacuum application.

Position the pressure transducer and its vacuum line in such a way that condensate cannot flow towards the pressure transducer.

Allow the equipment to equilibrate to ambient temperature if you bring it from cold environment into a room prior to operation. Notice if there is water condensation on cold surfaces.

Comply with all **applicable and relevant safety requirements** (regulations and guidelines). **Implement the required actions and adopt suitable safety measures.**

Ambient conditions**⚠ DANGER**

- ➔ Do not reach for this product if it has fallen into liquid. There is a risk of deadly electrical shock. Unplug the system immediately.

⚠ WARNING

- ☞ Do not use this product in an area where it can fall or be pulled into water or other liquids.

CAUTION

- Adopt suitable measures in case of differences from recommended conditions, e.g., using the equipment outdoors, or in an atmosphere of conductive pollution or external condensation.
- Do not operate this product near flames.

NOTICE

To the best of our knowledge the equipment is in compliance with the requirements of the applicable EC-directives and harmonized standards (see "Declaration of Conformity") with regard to design, type and model. Directive EN 61010-1 gives in detail the conditions under which the equipment can be operated safely (see also IP degree of protection, "Technical data", pg. 21).

Operating conditions

DANGER

- ➔ This device is not approved for operation in potentially explosive atmospheres. **Do not operate the device in potentially explosive atmospheres.**
- ➔ Devices **without the "Ex" mark on the rating plate are not approved for operation with dangerous or explosive gases or with potentially explosive or inflammable substances. Do not operate the device with dangerous or explosive gases or with potentially explosive or inflammable substances.**
- ➔ Devices **bearing the "Ex" mark on their rating plates are approved for operation with potentially explosive atmospheres** according to their classification **II 3G IIC T3 X** according to ATEX, but they are **not approved for operation in potentially explosive atmospheres** (see section "**Ex** Important information: Equipment marking (ATEX)", pg. 19).

CAUTION

- Ensure that the materials of the vacuum gauge's wetted parts are compatible with the substances in the vacuum system, see section "Technical data", pg. 21.

Safety during operation

DANGER

- ➔ Adopt suitable measures to prevent the release of dangerous, toxic, explosive, corrosive, noxious or polluting fluids, vapors and gases.

WARNING

- ☞ Never operate this vacuum gauge if it has a damaged cord or plug. If the vacuum gauge is not working properly, has been dropped or has fallen into water, contact your service provider.
- ☞ Prevent any part of the human body from coming into contact with vacuum.

Operation with pressure transducer **VSK 3000**:

- ☞ **Attention:** At pressures above approximately 795 Torr (1060 mbar) the pressure reading becomes incorrect due to saturation of the pressure transducer. The display flashes. Release pressure immediately! **Risk of bursting!**

Operation with pressure transducer **VSP 3000**:

- ☞ **Attention:** Maximum pressure reading: $7.5 \cdot 10^2$ Torr ($1 \cdot 10^3$ mbar). Pressure values above $7.5 \cdot 10^2$ Torr ($1 \cdot 10^3$ mbar) can not be displayed. **Danger of unnoticed overpressure! Risk of bursting!**

Operation with pressure transducer **MPT 100**:

- ☞ See instructions for use of MPT 100.

NOTICE

Electronic equipment is never 100% fail-safe. This may lead to an ill-defined status of the equipment or of other connected devices. Provide appropriate protective measures to allow for the possibility of failure and malfunction. The protective measures must also allow for the requirements of the respective application.

Maintenance and repair

⚠ DANGER



- ➔ **Switch off the vacuum gauge. Disconnect the power supply and wait five seconds** before starting maintenance to allow the capacitors to discharge.
- ➔ **Note:** The equipment may be contaminated with chemicals, which have been processed during operation. Ensure that the equipment is completely decontaminated before maintenance commences. Take adequate precautions to protect people from the effects of dangerous substances if contamination has occurred. Use appropriate protective clothing, safety goggles and protective gloves.

NOTICE

Ensure that **maintenance** is done only by suitably trained and supervised technicians. Ensure that the maintenance technician is familiar with the safety procedures which relate to the products processed in the vacuum system.

Interior components of the controller can only be repaired at the factory. Return the pressure transducer to the factory for repair. Opening the housing of a pressure transducer will void any warranty.

In order to comply with laws (occupational, health and safety regulations, safety at work law and regulations for environmental protection) components and measuring instruments can only be returned when certain procedures (see section “**Repair - Maintenance - Return - Calibration**”, pg. 59) are followed.

 Important information: Equipment marking (ATEX)**VACUUBRAND equipment bearing mark (see rating plate)**

 II 3G IIC T3 X
Internal Atm. only
Tech. File Ref.: VAC-EX01

The classification II 3G IIC T3 X according to ATEX is only valid for the inner part (wetted part, pumped gas or vapor) of the equipment. The equipment is not suitable for use in external, potentially explosive atmospheres (environment).

The overall category of the equipment depends on the connected components. If the connected components do not comply with the classification of the VACUUBRAND equipment, the specified category of the VACUUBRAND equipment is no longer valid.

Vacuum pumps and vacuum gauges in category 3 are intended for connection to equipment in which during normal operation explosive atmospheres caused by gases, vapors or mists normally don't occur; or, if they do occur, are likely to do so only infrequently and for a short period only. Equipment in this category ensures the requisite level of protection during normal operation.

The use of gas ballast or the operation of venting valves is only permitted if thereby explosive atmospheres normally don't occur in the interior of the equipment or, if they do occur, are likely to do so only infrequently and for a short period.

The pumps are marked with "X" (according to EN 13463-1), i.e., restrictions of the operation conditions:

- The equipment is designated for a low degree of mechanical stress and has to be installed in a way so that it cannot be damaged from outside.
Pumping units have to be installed so that they are protected against shocks from the outside and against glass splinters in the event of breakage (implosion).

- The equipment is designated for an ambient and gas inlet temperature during operation of +10 to +40°C. Never exceed these ambient and gas inlet temperatures. If pumping / measuring gases which are not potentially explosive, extended gas inlet temperatures are permissible. See instructions for use, section “Gas inlet temperatures” or “Technical data”.

After any intervention at the equipment (e.g., repair / maintenance) the ultimate vacuum of the pump has to be checked. Only if the pump achieves its specified ultimate vacuum is the pump’s leak rate low enough to ensure that no explosive atmospheres will occur in the interior of the equipment.

After any intervention at the vacuum sensor, the leak rate of the equipment has to be checked.



Attention: This manual is not available in all languages of the EU. The user must not operate the device if he does not understand this manual. In this case a technically correct translation of the complete manual has to be available. The manual must be completely read and understood before operation of the device. All specified measures must be applied, or else must be replaced by equivalent measures at the user’s own risk.

Technical data

Technical data of display unit

Display unit	DCP 3000
Display	LCD graphic display, illuminated
Pressure units / scale (selectable)	Torr, mbar or hPa
Measurement range with active pressure transducer: VSK 3000 VSP 3000 MPT 100	795 Torr - 0.1 Torr (1060 mbar - 0.1 mbar) 7.5*10 ² Torr - 1*10 ⁻³ Torr (1*10 ³ mbar - 1*10 ⁻³ mbar) 7.5*10 ² Torr - 3.7*10 ⁻⁹ Torr (1*10 ³ mbar - 5*10 ⁻⁹ mbar)
Ambient temperature range (operation)	50°F to 104°F (10°C to +40°C)
Ambient temperature range (storage)	14°F to 158°F (-10°C to +70°C)
Permissible relative atmospheric moisture during operation (no condensation)	30% to 85%
Maximum permissible range of supply voltage (±25%)	24V DC
Maximum power draw	3.4W (140mA at 24V DC)
Maximum permitted current of connected valves (connected components)	4A (with sufficiently powerful power supply)
Degree of protection IEC 529 (front side)	IP 42
Interface	RS-232 C
Weight (approx.; without power supply)	0.97 lbs. (0.44kg)
Dimensions L x W x H (incl. foot)	5.7" x 4.9" x 4.5" (144 mm x 124 mm x 114 mm)

Technical data of pressure transducers

Type	VSK 3000	VSP 3000
Pressure transducer	ceramic diaphragm (alumina), capacitive, absolute pressure, gas type independent	thermal conductivity according to Pirani, gas type dependent
Measuring range (absolute)	795 - 0.1 Torr (1060 - 0.1 mbar)	$7.5 \cdot 10^2$ Torr - $1 \cdot 10^{-3}$ Torr ($1 \cdot 10^3$ mbar - $1 \cdot 10^{-3}$ mbar)
Resolution	0.1 Torr (mbar)	10% of displayed decade
Measurement uncertainty (absolute) after careful adjustment and at constant temperature	$<\pm 0.75$ Torr (1 mbar) / ± 1 digit	$1 \cdot 10^1$ Torr - $1 \cdot 10^{-2}$ Torr ($1 \cdot 10^1$ mbar - $1 \cdot 10^{-2}$ mbar): $\pm 15\%$ of displayed value
Maximum permissible pressure at pressure transducer (absolute)	1125 Torr (1.5 bar) absolute	
Maximum permissible temperature of gaseous media at pressure transducer*	continuous operation: 104°F (40°C), for short periods (less than 5 minutes) up to 176°F (80°C)	
Temperature coefficient	$<\pm 0.05$ Torr/K (0.07 mbar/K)	not specified
Ambient temperature range (operation)	50°F to 104°F (10°C to +40°C)	
Ambient temperature range (storage)	14°F to 140°F (-10°C to +60°C)	
Permissible relative atmospheric moisture during operation (no condensation)	30% to 85%	
Range of supply voltage (via VACUU•BUS)	6-30 VDC / 5 mA	18-30 VDC / 65 mA
Degree of protection IEC 529	IP 54	
Communication	VACUU•BUS	
Weight with small flange with hose nozzle with tubing connection	6.53 oz (185 g) 6.35 oz (180 g) 6.28 oz (178 g)	6.35 oz (180 g) 6.53 oz (185 g) -

* if using potentially explosive atmospheres (only VSK 3000): 50 °F to 104 °F (+10°C to +40°C)

We reserve the right for technical modification without prior notice!

Type	VSK 3000	VSP 3000
Housing dimensions diameter length with small flange with hose nozzle with connection for PTFE tube	2.4" (60 mm) 2.4" (60 mm) 3.7" (95 mm) 2.5" (63 mm)	2.4" (60 mm) 2.3" (58 mm) 3.8" (97 mm) -
Vacuum connection	small flange KF 16 or hose nozzle for tubing I.D. 1/4" / 3/8" (6 / 10 mm) or connection for PTFE tube I.D. 3/8", O.D. 5/16" (10 / 8 mm)	small flange KF 16 and screw-in hose nozzle for tubing I.D. 1/4" / 3/8" (6 / 10 mm)
Internal volume of measurement chamber	with small flange: 0.25 in ³ (4.1 cm ³) with hose nozzle: 0.27 in ³ (4.4 cm ³) with connection for PTFE tube: 0.21 in ³ (3.5 cm ³)	1.8 in ³ (2.9 cm ³) with hose nozzle: 0.15 in ³ (2.5 cm ³)
Cable length	approximately 6'7" (2.0 m)	

Technical data MPT 100: See instructions for use of MPT 100

Technical data of power supply

Power supply (wall plug)	
Input voltage (±10%)	100-240 V~ / 47-63 Hz
Maximum current draw	0.8 A
Ambient temperature range (operation)	32°F to 104°F (0°C to +40°C)
Ambient temperature range (storage)	-4°F to 185°F (-20°C to +85°C)
Output voltage	24V DC / short-circuit proof
Maximum output current	1.25 A
Power connection	exchangeable plug Europe / UK / US / AUS
Cable length (approx.)	6'7" (2m)
Dimensions	4¼" x 2¼" x 1⅜" 108mm x 58mm x 34mm
Weight (approx.)	0.53 lbs. (0.24 kg)

We reserve the right for technical modification without prior notice!

Wetted parts

Components	Wetted materials
VSK 3000	
Sensor	Aluminum oxide ceramic
Sensor housing, measurement chamber	PPS, glass fiber
Seal at sensor	Chemically resistant fluoroelastomer
Hose nozzle	PP
Clamping ring	PA
Small flange	Stainless steel
VSP 3000	
Sensor	Aluminum oxide ceramic
Sensor housing, measurement chamber, small flange	PBT, glass fiber / PUR
Hose nozzle / O-ring	PPS, glass fiber / FPM

Abbreviations

- FPM:** Fluoroelastomer
- PA:** Polyamide
- PBT:** Polybutylene terephthalate
- PP:** Polypropylene
- PPS:** Polyphenylene sulfide
- PUR:** Polyurethane

We reserve the right for technical modification without prior notice!

Use and operation

Assembling the country-specific power plug



- The wall power supply is delivered with power plugs for Europe, UK, US and Australia.
- Press the locking key on the wall power supply to remove and to replace the power plug with your country-specific plug.
- Assemble the suitable power plug to the power supply and lock.

Display and symbols

When switching on the DCP 3000 for the very first time, a menu to select the language of the vacuum gauge's menu is displayed. Select the desired language (e.g., "English") by turning the selection knob and press to confirm. Then select the pressure unit ("mbar", "Torr" or "hPa") in the same way.

It is possible to access the language selection menu at any time by switching on the vacuum gauge while keeping the selection knob pressed.

After switching on the device, the **version number of the software** is displayed, followed by the preselected function and the pressure reading.

Connected components (e.g., valves, external pressure transducer 3000 series) are automatically identified.

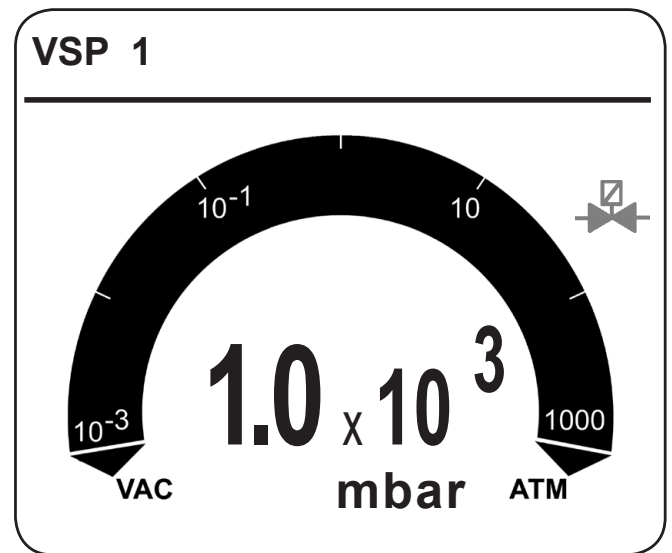
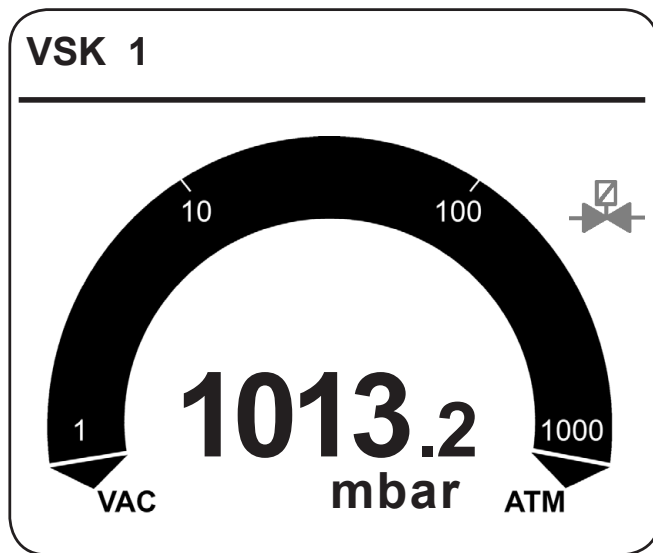

VSK 1 / VSP 1 active pressure transducer (status line)



venting valve switched on (if connected)



warning notice (if necessary in combination with other symbols), flashing

1013.2 actual absolute pressure at the pressure transducer

mbar

Torr

hPa

preselected pressure unit

Selection knob

- Press to reach the set-up menu of the function
- Turn to choose the parameter you want to modify
- Press to select the parameter you want to modify
- Turn to change the set value of the parameter
- Press to confirm change of value and to reach further parameters, or to leave the set-up menu

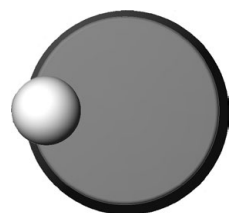

Keys

VENT:

(Functions only after connection of an **external venting valve**)

- A short tap vents momentarily
- Pressing longer than 2 seconds vents the system to atmospheric pressure.

ON/OFF switch

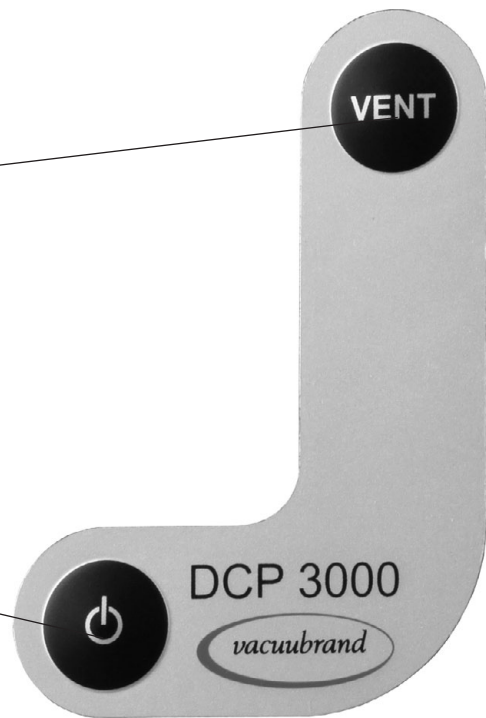

Rear side DCP 3000

jacks for connection of external pressure transducer and/or venting valve

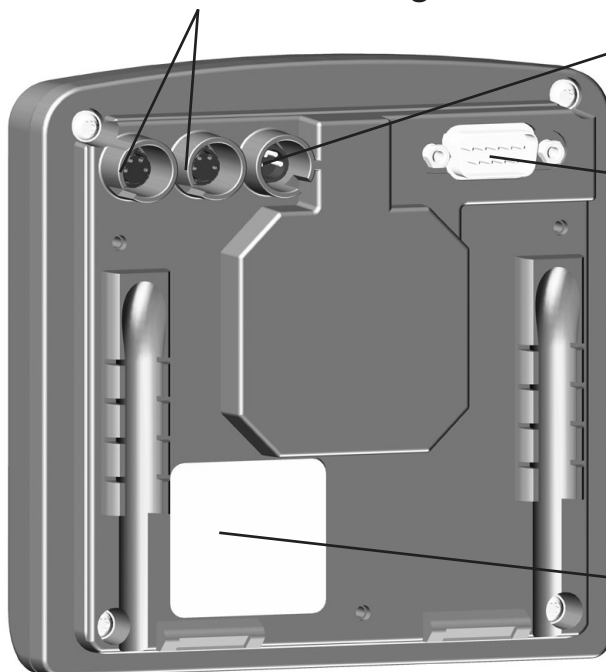

Connection plug of the power supply

serial interface
RS-232 C

rating plate

Attention: Do not assemble or remove plug connections off-axis! Orient the plug correctly before inserting. To connect additional components use VACUU•BUS Y-adapters and extension cables. If an external pressure transducer or valve is connected, it is recognized automatically. Further information on how to use several sensors or valves simultaneously is available upon request.

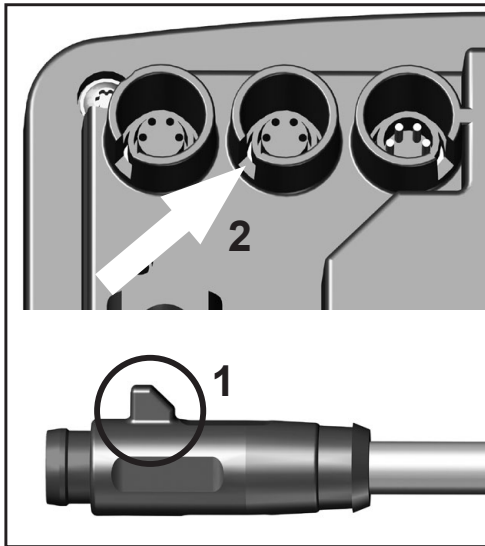

Depending on technical version the connections of the VACUU•BUS cables are equipped with a nib.

When connecting the VACUU•BUS connections to the rear side of the vacuum gauge position the nib (1) of the VACUU•BUS connection in the notch (2) of the vacuum gauge connections.

Changing the vacuum connector at pressure transducer VSK 3000

Installing the hose nozzle:

Unscrew the flange (using a 17 mm open-end wrench, if necessary) to expose the compression fitting (1). Slip the compression nut, and then the ferrule, onto the smooth end of the supplied hose nozzle (2). Slide the smooth end of the hose nozzle onto the compression fitting on the VSK 3000 gauge head, and tighten the compression nut firmly finger-tight (3).

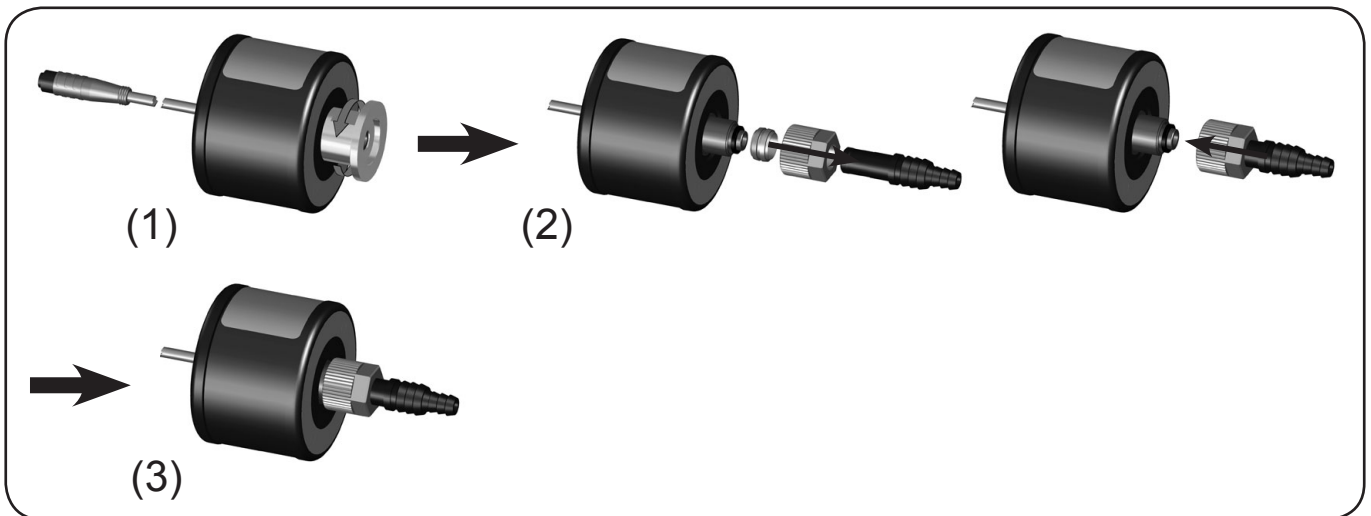

Installing the PTFE-tubing connection (PTFE-tubing ID: 8mm, OD: 19mm):

Unscrew the flange (using a 17 mm open-end wrench, if necessary) to expose the compression fitting (1). Slip the compression nut, and then the ferrule, onto the PTFE-tubing (2). Slide the PTFE-tubing onto the compression fitting on the VSK 3000 gauge head, and tighten the compression nut firmly finger-tight (3).

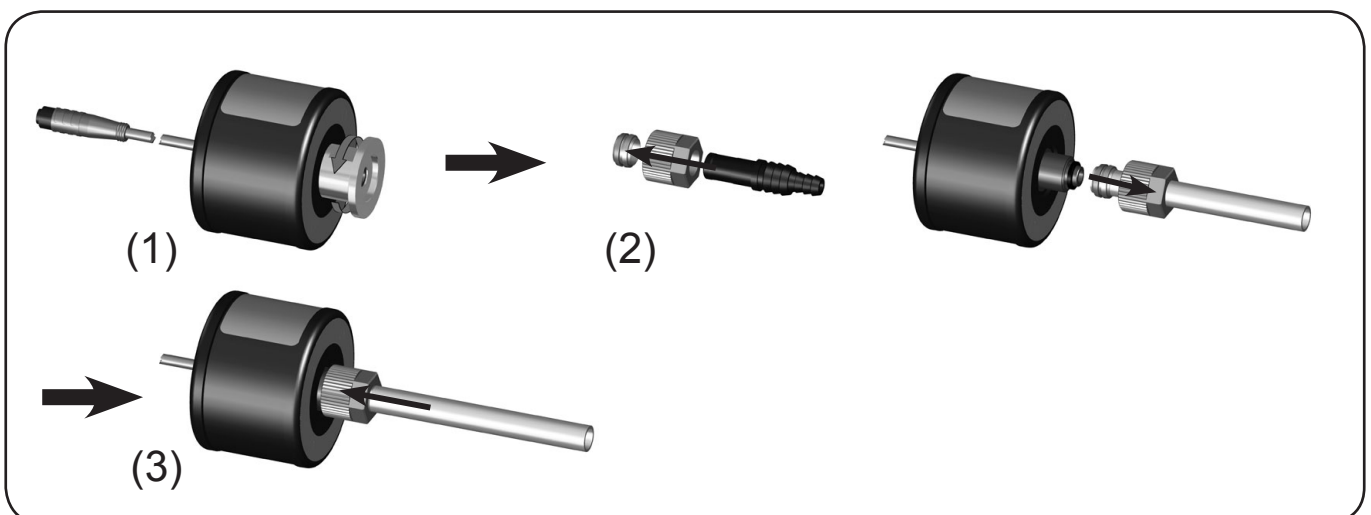

Notes on operation

Operation principle of the VSK 3000

The VSK 3000 is equipped with a capacitive pressure transducer with ceramic diaphragm to measure the actual pressure **independent of the gas type** and depending on the vacuum, i.e., **absolute**.

The pressure value is displayed with a resolution of 0.1 Torr (mbar) in the pressure range from 0.1 to 795 Torr (0.1 to 1060 mbar).

Operation principle VSP 3000

The pressure transducer VSP 3000 relies on the fact that the thermal conductivity of the residual gas in the vacuum chamber is a measure for the gas pressure. The thermal conductivity of gases is proportional to the pressure within a certain range and is related to the molecular mass.

The thermal conductivity of gases and vapors varies with their molecular mass. Therefore the pressure measurement is dependent on the gas type. The pressure transducer has been adjusted for air at the factory.

- ☞ Pressure of gases with similar mass, such as O_2 or CO , can be read off directly within the uncertainty of the measurement.
- ☞ With gases of lower or higher mass (H_2 , He, Ar, CO_2) it is recommended to readjust the VSP 3000 using the gas to be measured.

Diagram: Gas dependence of a VSP 3000

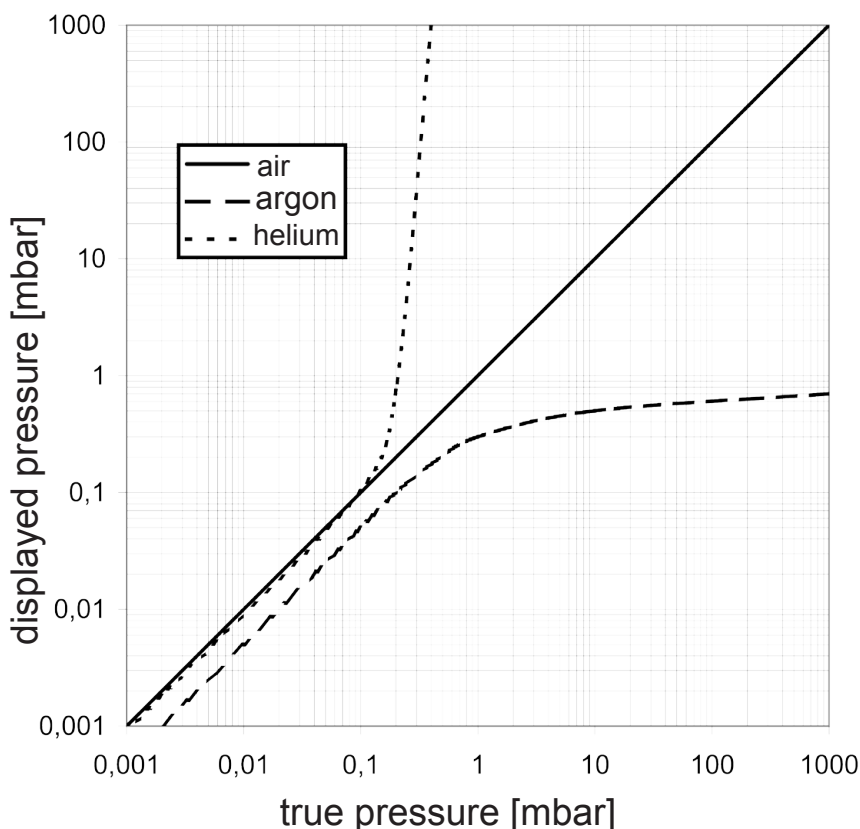

General information on handling the VSP 3000

The VSP 3000 pressure transducer which has been developed particularly for use in chemical laboratories is a pressure sensor working in the fine vacuum range. Over the whole measuring range the pressure reading is indicated in exponential notation.

Allow the VSP 3000 a period of approx. 20 minutes to preheat and to meet its specifications. Even in case of the vacuum gauge being switched off, the VSP 3000 stays ready for operation. To de-energize the pressure transducer, unplug either its VACUU•BUS line or the power supply of the vacuum gauge.

NOTICE

The interior of the pressure transducer is highly sensitive! Do not insert fingers or tools into the measuring chamber.

VACUU•BUS

Read the pressure transducer with the DCP 3000 vacuum gauge, connected via VACUU•BUS line. Maximum cable length inside buildings: 30m (~32yd) (extension cable VACUU•BUS 2m (6.6ft): order-no. 612552 / extension cable VACUU•BUS 10m (32.8ft): order-no. 2618493).

Do not use more than one DCP 3000 within the same VACUU•BUS system. Several DCP 3000 in the same VACUU•BUS system will interfere with each other and result in error messages of the connected components (pressure transducers, valves).

Prior to use

- Connect the VSK 3000 or VSP 3000 gauge head by its connecting cable (VACUU•BUS line) to a jack at the rear side of the DCP 3000.
- Connect the gauge head to the vacuum chamber via either the small flange connection, the hose nozzle, or PTFE tubing. Avoid contamination (oil/oil mist) of the gauge head when generating the vacuum with an oil-sealed vacuum pump.
- ☞ Do not position the gauge head directly at the inlet of an oil-sealed pump. The diameter of the connecting tubing should be as large as possible.

- ☞ Inside a vacuum system where evaporation occurs, e.g., a rotary evaporator, the vacuum is not uniform. For example, a condenser can act as a pump, or the vacuum in the connecting tubing can be higher or lower than in the application itself. This affects the measurement results. Therefore, carefully choose the position at which to connect the pressure transducer.
- ☞ Condensate and deposits will affect the measurement results.
- ☞ If residues occur or when working with aggressive or condensable substances, install a gas washing bottle in front of the pressure transducer.
- ☞ **Position the pressure transducer in such a way that condensate cannot flow towards it.**

VSP 3000:

Recommended orientation: Vertically with vacuum connection pointing downwards. If mounting the VSP 3000 in any other orientation, a readjustment is recommended (see section “Readjustment of VSP 3000”, pg. 57).

- ☞ If necessary, clean the gauge head.

- Switch the equipment on.

Automatic identification of connected components

When switching on the device, the configuration of the connected components is checked.

Connected components (valves, pressure transducers, etc.) are **automatically identified**, used and monitored until the device is switched off. Reconfiguration is possible by switching the DCP 3000 off/on. Identical components must be configured beforehand to different VACUU•BUS addresses (e.g., VSK 1 and VSK 2), see section “Connecting several pressure transducers”, pg. 38; further information upon request.

The configuration menu for specific settings, see section “Configuration”, pg. 36, reflects automatically the connected components.

The types of components connected (e.g., valves) determine the active menu items.



☞ Maximum permissible pressure at the pressure transducer: 21.8 psi (1.5 bar) absolute.



VSK 3000:

☞ **Attention:** At pressures above approximately 795 Torr (1060 mbar) the pressure reading becomes incorrect due to saturation of the pressure transducer. The display flashes. Release pressure immediately!
Risk of bursting!

VSP 3000:

☞ **Attention:** Maximum pressure reading: 7.5×10^2 Torr (1×10^3 mbar). Pressure values above 7.5×10^2 Torr (1×10^3 mbar) are not displayed. **Risk of unnoticed overpressure.**
Risk of bursting!

Menu guide

pressure indication with VSK 3000

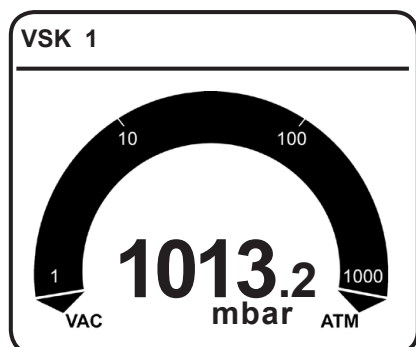

pressure indication with VSP 3000

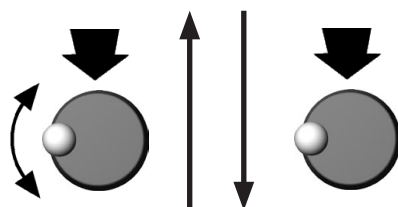
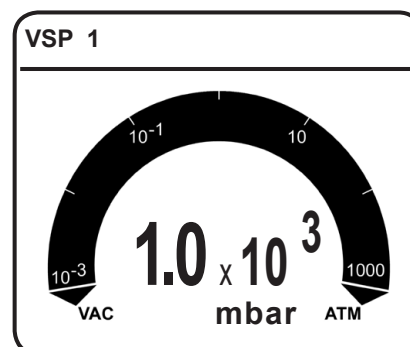

Configuration

Adjustment	760 Torr
RS-232 . . .	
Sensors . . .	
Display . . .	
Setpoint . . .	
Log Data	Off
----- Graphic -----	
----- Back -----	

Switching between connected pressure transducers during pressure indication or graphic display:

- ➡ Press the selection knob and keep pressed. Then turn the still pressed selection knob until the desired pressure transducer is displayed. Release selection knob.

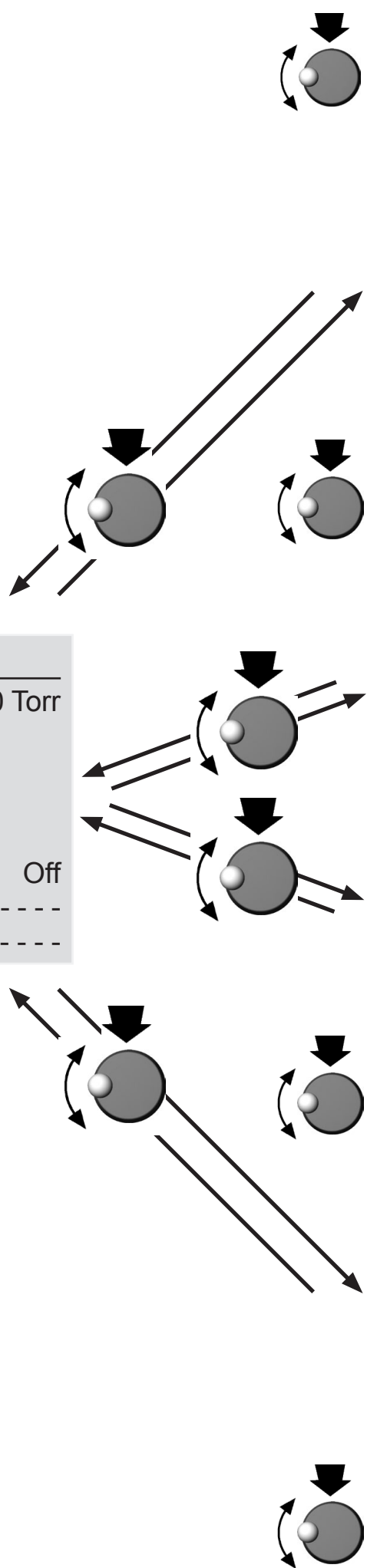

RS-232	
Baud	19200
Parity	8-N-1
Handshake	RTS-CTS
Send	Off
Data	Cancel
----- Back -----	

Sensors	
VSK 1	750 Torr
VSP 1	1.0E+2 Torr
VSK 2	600 Torr
VSP 2	7.8E+1 Torr
----- Back -----	

Configuration	
Adjustment	760 Torr
RS-232 . . .	
Sensors . . .	
Display . . .	
Setpoint . . .	
Log Data	Off
----- Graphic -----	
----- Back -----	

Display	
Brightness	100%
Contrast	40%
Sound	Off
Unit	Torr
Language	English
----- Back -----	

Setpoint	
On 1	50 Torr
Off 1	10 Torr
On 2	9E-2 Torr
Off 2	5 Torr
----- Back -----	

Configuration

In the "Configuration" menu the device parameters are preselected.

Preselections

- ☞ Use the selection knob to select the parameters.
- Switch the DCP 3000 on.
- Press the selection knob.
- Turn the selection knob to choose a menu and confirm by pressing the selection knob.

"Configuration"

Settings for

- Adjustment (of the pressure transducer)
- RS-232 (serial interface)
- Sensors (configuration and switching between several pressure transducers)
- Display (brightness and contrast of the display, language, sound,.....)
- Setpoint (valves, digital I/O interface)
- Log Data (Off, 1 . . . 3600 seconds)
- Graphic

- ☞ **Adjustment:** Adjustment of the pressure transducer under vacuum and/or at atmospheric pressure. See also sections, "Readjustment of VSK 3000", pg. 55. / "Readjustment of VSP 3000", pg. 57.

Adjustment is carried out at two adjustment points: at atmospheric pressure and under vacuum.

If no adjustment is possible in the actual pressure range, "---- Torr" is displayed.

- ☞ **RS-232:** Configuration of the interface, setting of parameters and commands, see section "Interface parameters", pg. 44.

Baud rate can be set to 19200, 9600, 4800 or 2400, parity on "8-N-1", "7-O-1" or "7-E-1", Handshake on "no", "Xon-Xoff" or "RTS-CTS" and remote on "On" or "Off".

Automatic sending of pressure values "off" (only on demand) or in a time interval of 1 3600 seconds.

To switch off automatic sending select "off" or stop via serial interface. Send recorded data. See section "Notes concerning the data logger function (recording and sending of data)", pg. 45.

- ☞ **Sensors:** Selection of the pressure transducer to be controlled. Maximum number of pressure transducers of the same type (VSK 3000 or VSP 3000 or VSK 3000 configured as reference) connected to one DCP 3000: four. You may replace up to four VSP 3000 pressure transducers by MPT 100 pressure transducers.
- ☞ **Display:** Selection of the device parameters "*Brightness*" between 0 - 100%; "*Contrast*" between 0 - 100%; "*Sound*" "On" or "Off"; "*Units*" "mbar", "hPa" or "Torr"; "*Language*" "German", "English", "French", "Italian", "Spanish", "Turkish", "Korean", "Chinese", "Portuguese", "Russian", "Polish", "Dutch", "Japanese", "Finnish".
- ☞ **Setpoint:** Maximum four "On" setpoints and four "Off" setpoints can be preset after appropriate configuration of valves and / or digital I/O interfaces (see section "Setpoints", pg. 42).
- ☞ **Log data:** Recording and internal storage of time and pressure data of up to 4 pressure transducers (Log Data "Off" or interval 1 . . . 3600 seconds)

The screen-shot shows the factory-set values.

Configuration	
Adjustment	760 Torr
RS-232 . . .	
Sensors . . .	
Display . . .	
Setpoint . . .	
Log Data	Off
----- Graphic -----	
----- Back -----	

Connecting several pressure transducers

It is possible to connect several external pressure transducers simultaneously to the DCP 3000. Maximum number of pressure transducers of the same type (VSK 3000 or VSP 3000) connected to one DCP 3000: four. Alternatively connect one MPT 100 instead of one VSP 3000 (requires DCP 3000 software version 2.03 or higher) or up to four MPT 100 instead of VSP 3000 (requires DCP 3000 software version 2.22 or higher). That is a total of eight external pressure transducers at maximum. Up to four additional pressure transducers VSK 3000 may be connected as reference if configured accordingly (see "Measuring differential pressure" below). Only the reading of one pressure transducer is displayed at a time.

- ☞ The VACUU•BUS address of the active and displayed pressure transducer is shown in the upper left corner (status line). The readings of all pressure transducers are shown in the "Sensors" menu. If a sensor is flashing in the "Sensors" menu, this indicates a fault at that sensor.
- ☞ Each pressure transducer requires an individual address (VSK 1 to VSK 4 / VSP 1 to VSP 4 / MPT 1 to MPT 4) to communicate with the DCP 3000 via VACUU•BUS. All pressure transducers are shipped with their VACUU•BUS addresses factory-set to VSK 1 or VSP 1 or MPT 1.
- ☞ Use the DCP 3000 to reconfigure the pressure transducers VSK 3000 or VSP 3000 (e.g., changing the VACUU•BUS address from VSK 1 to VSK 2). See section "Reconfiguring the pressure transducer" below. Configuration of the MPT 100: See instructions for use of the MPT 100.

Manual switching between pressure transducers

1st possibility:

- Select the menu item "Sensors" in the "Configuration" menu.
- ☞ Connected pressure transducers are displayed in the order of their VACUU•BUS address: VSK 1 - VSP 1 - VSK 2 - VSP 2 - ... - VSP 4.
- Select the desired pressure transducer by turning and pressing the selection knob.
- Press the selection knob again to leave the configuration menu.
- ☞ The selected pressure transducer is displayed in the status line as active pressure transducer.

2nd possibility:

- ☞ Switching during pressure indication or graphic display
- ➡ Press the selection knob and keep pressed.
- ➡ Turn the selection knob while still pressed until the desired pressure transducer is indicated (see VACUU•BUS address in the status line).
- ➡ Release the selection knob.
- ☞ The selected pressure transducer is displayed in the status line as the active pressure transducer.

Automatic switching between pressure transducers VSK 3000 and VSP 3000

If both a pressure transducer VSK 3000 and VSP 3000 are connected to the vacuum gauge DCP 3000, the DCP 3000 automatically displays the readings of the pressure transducer more suitable in the current pressure range.

This requires both pressure transducers to be configured to corresponding VACUU•BUS addresses (i.e. VSK x and VSP x). If the two VACUU•BUS addresses do not correspond (i.e. VSK x and VSP y), an automatic switching between pressure transducers is not possible. It then is necessary to reconfigure the address of one pressure transducer in order to enable automatic switching (see section "Reconfiguring the pressure transducer" below).

Switchover points between pressure transducers VSK 3000 and VSP 3000:

In case of decreasing pressure: Switching from VSK 3000 to VSP 3000 at a pressure of 0.7 Torr (1 mbar)

In case of increasing pressure: Switching from VSP 3000 to VSK 3000 at a pressure of 3.7 Torr (5 mbar)

The active pressure transducer is shown in the status line. Furthermore, a VSK 3000 is always displayed in decimal notation, a VSP 3000 in exponential notation.

Measuring differential pressure

A differential pressure between two pressure transducers can only be

determined and indicated between two VSK 3000 pressure transducers connected to the DCP 3000.

- ☞ This requires one of the two pressure transducers to be defined as reference (e.g., VACUU•BUS address "Ref. 1").
- ☞ In addition, both pressure transducers have to be configured to corresponding VACUU•BUS addresses (VSK x and Ref. x). If the two addresses do not correspond (VSK x and Ref. y), no differential pressure will be determined or displayed. Then it is necessary to reconfigure the address of one pressure transducer to enable differential pressure measurement (see section "Reconfiguring the pressure transducer" below).
- ➡ The displayed pressure value is: ("pressure value of Ref. x" minus "pressure value of VSK x") Torr

Reconfiguring the pressure transducer VSP 3000 or VSK 3000

Configuration of the MPT 100: See instructions for use of MPT 100.

Reconfiguring the VACUU•BUS address of a pressure transducer:

1. Switch the vacuum gauge DCP 3000 off.
2. Preferably connect only the pressure transducer to be reconfigured to the DCP 3000.
3. Keep the "VENT" key pressed and switch the DCP 3000 on ("ON/OFF" key). Release the "VENT" key.
4. Select the menu item "Vacuubus" by turning and pressing the selection knob.
5. The first component detected by the VACUU•BUS is displayed (e.g., VSK 1). If necessary, select the pressure transducer to be reconfigured by turning and pressing the selection knob.
6. Press the "VENT" key and keep pressed, then press additionally the selection knob. A frame will replace the inverse display of the component. Release the "VENT" key.
7. Turn the selection knob until the address, to which you want to reconfigure the pressure transducer (e.g., VSK 2 or Ref.1), is displayed.
8. Press the selection knob. If the configuration was successful, the menu is left and the DCP 3000 will restart.

A configuration of more than one pressure transducer to the same VACUU•BUS address will result in error conditions at the DCP 3000 and must therefore be avoided!

Do not configure a VSK 3000 as VSP 3000.

Do not configure a VSP 3000 as VSK 3000.

Further information concerning the configuration of other components (e.g., valves) upon request.

Setpoints

Valves (see “Accessories”, pg. 52) can, after appropriate configuration, be opened or closed at preset “On” and “Off” setpoints. Thus the switching of the valves is controlled by the measured system pressure.

The digital I/O interface can be used as interface for existing (provided by the customer) isolation, coolant, or venting valves, in case these components are not equipped with a VACUU•BUS™ connection. The component has to be connected to the output of the module; an additional voltage supply is required.

Requirements for working with setpoints:

To switch a valve or an I/O interface connected to the DCP 3000 pressure-dependently, the following requirements must be met:

- at least one external pressure transducer VSK 3000, VSP 3000 or MPT 100 is connected to the DCP 3000 vacuum gauge (VACUU•BUS address “VSK x”, “VSP x” or “MPT x”).
- a valve or a digital I/O interface is connected to the DCP 3000 and configured to the according VACUU•BUS address “SP x” to be operated by setpoints (see below on how to configure components for working with setpoints).
- an “On” setpoint “On x” or an “Off” setpoint “Off x” for switching the valve/interface is preset.
- all required components and setpoints have to be configured to **corresponding VACUU•BUS addresses** (e.g., pressure transducer “VSK 1”, valve “SP 1”, “On” setpoint “On 1”, “Off” setpoint “Off 1”). The same applies to VACUU•BUS addresses “... 2”, “... 3” and “... 4”.

Setting setpoints:

Go to the configuration menu and select the submenu “Setpoint”. You may preset four pressure values as “On” setpoints (“On 1”, ..., “On 4”) and four “Off” setpoints (“Off 1”, ..., “Off 4”).

Thus, for each valve or I/O interface one “On” setpoint and one “Off” setpoint can be set. The setting range depends on the measuring range of the pressure transducer connected to the DCP 3000.

Example:

If the “On” setpoint “On 1” is set to 500 Torr and a pressure less than or equal to 500 Torr is measured by the corresponding pressure transducer

"VSK 1", a connected valve "SP 1" opens. At pressures above 500 Torr, the valve remains closed. If the "Off" setpoint "Off 1" is set to 70 Torr and a pressure less than or equal to 70 Torr is measured by the corresponding pressure transducer "VSK 1", a connected valve "SP 1" closes. At pressures above 70 Torr, the valve remains open.

A setpoint can be used e.g., to open an in-line valve between a backing pump and a turbomolecular or diffusion pump once a specified backing pressure has been reached.

Configuring valves or digital I/O interfaces for operation with setpoints

Reconfiguring the VACUU•BUS addresses of valves or digital I/O interfaces:

1. Switch the vacuum gauge DCP 3000 off.
2. Preferably connect only the component to be reconfigured to the DCP 3000.
3. Keep the "VENT" key pressed and switch the DCP 3000 on ("ON/OFF" key). Release the "VENT" key.
4. Select the menu item "Vacuubus" by turning and pressing the selection knob.
5. The first component detected by the VACUU•BUS is displayed (e.g., "Isol.v.1"). If necessary, select the component to be reconfigured by turning and pressing the selection knob.
6. Press the "VENT" key and keep pressed, then press additionally the selection knob. A frame will replace the inverse display of the component. Release the "VENT" key.
7. Turn the selection knob until the address, to which you want to reconfigure the component (e.g., "SP 1" or "SP 2"), is displayed.
8. Press the selection knob. If the configuration was successful, the menu is left and the DCP 3000 will restart.

A configuration of more than one component to the same VACUU•BUS address will result in error conditions at the DCP 3000 and must therefore be avoided!

Further information concerning the configuration of other components upon request.

Interface parameters

The vacuum gauge DCP 3000 is equipped with a serial interface (RS 232C, nine-pin Sub-D-plug).

- ☞ Plug-in or remove the cable (cable RS 232C) from the interface only if the equipment is switched off.
- ☞ The interface is **not** electrically isolated from the measuring circuit.
- ☞ For optimal electromagnetic compatibility assemble an interface filter (cat. no.: 638235).

- ☞ The serial interface is prepared for the connection of a commercial Bluetooth adapter for wireless communication (current supply for Bluetooth adapter on pin 9, see "Pin assignment").

- ☞ Settings via interface are stored.

Setting of the interface

Set the interface parameters directly at the DCP 3000. The factory set values are underlined.

Edit and confirm the interface parameters in the "Configuration" menu in "RS-232" submenu using the selection knob.

- Baud: 2400, 4800, 9600 or 19200
- Parity: 8-N-1, 7-O-1 or 7-E-1
- Handshake: Off, Xon-Xoff or RTS-CTS
- Send: Off or 1.....3600 s
- Data: Send

- A maximum of twenty commands per second is possible.
- The commands have to be written in capital letters.
- Command and parameter have to be separated by a blank.
- The string is terminated with <CR> or <LF> or <CR><LF>.
- The response of the controller is always terminated with <CR><LF>.
- Numerical values and parameters can be written without leading zeros.
- The response of the controller always includes leading zeros.

Notes concerning the data logger function (recording and sending of data)

- Maximum number of recordable readings: 32765.
- A runtime is displayed during the recording.
- The data of all connected pressure transducers are recorded, i.e., in case of two connected pressure transducers a maximum of 16382 readings per pressure transducer will be recorded.
- Recording starts, if "Log data" is set to a value from 1 to 3600 seconds (see "Configuration", pg. 36) and stops if "Log data" is set to "Off" or the device is switched off.
- If the recording interval is changed, stored readings are deleted and recording starts again.
- After a power failure the recording interval is set to "Off", the stored readings can be read out.

- "Graphic" (with or without function "log data") displays maximum 240 readings of the selected pressure transducer.
- If "Graphic" with function "log data" is selected, it is possible to extend the time scale to the next interval by turning the selection knob when the end of the displayed time scale is reached.
- If changing the displayed pressure transducer (without function "log data") the graphic starts anew.

- Readout of the stored readings is possible via RS 232 interface with the selected transfer parameters (see "Interface parameters", pg. 44).
- The data output format is ASCII.
- First the time is recorded, then the readings of all pressure transducers separated by space characters followed by the pressure unit.

Examples:

1. Data output in case of one connected pressure transducer, recording interval 1 second:

```
000.00:00:00 0105.8 Torr
000.00:00:01 0105.8 Torr
000.00:00:02 0105.8 Torr
000.00:00:03 0105.8 Torr
000.00:00:04 0105.8 Torr
000.00:00:05 0105.8 Torr
```

```
000.00:00:06 0105.8 Torr  
End
```

2. Data output in case of two connected pressure transducers (one VSK 3000, one VSP 3000), recording interval 5 seconds:

```
000.00:00:00 0105.8 3.70E-2 Torr  
000.00:00:05 0105.8 3.70E-2 Torr  
000.00:00:10 0105.8 3.70E-2 Torr  
000.00:00:15 0105.8 3.70E-2 Torr  
000.00:00:20 0105.8 3.70E-2 Torr  
000.00:00:25 0105.8 3.70E-2 Torr  
000.00:00:30 0105.8 3.70E-2 Torr  
000.00:00:35 0105.8 3.70E-2 Torr  
End
```

Depending on the amount of data and the transfer rate, the data output may take a very long time. The output of 32765 readings from one sensor takes up to 8 minutes at 19200 baud, longer than 1 hour at 2400 baud. Recording of data is possible with any terminal program.

Example: Windows* HyperTerminal: Select "Transfer menu - Capture text". In the file box, type a descriptive name for the file, and then click "Start". Send command "IN_PV_D" or select at the DCP 3000 "RS 232 - Data - Send".

* Windows is a trade mark of Microsoft Corporation in the USA and other countries.

Read commands

Command	Operation	Response	Description
IN_PV_1	current pressure	XXXX mbar/Torr/ hPa* X.XXE±X mbar/ Torr/hPa*	unit according to preselections
IN_PV_Sx	current pressure of pressure transducer x	XXXX mbar/hPa/ Torr* X.XXE±X mbar/ Torr/hPa*	pressure of pressure transducer x (order of numbering according to display in "Sensors" menu)
IN_PV_X	current pressure values of all connected pressure transducers	XXXX.X XXXX.X ...mbar/Torr/hPa* X.XXE±X X.XXE±X ...mbar/Torr/hPa*	pressure values of all connected pressure transducers
IN_PV_D	data readout	XXX.XX:XX:XX X ...mbar/Torr/hPa*	read out data from DCP 3000 memory
IN_CFG	device set preselections	yXXXXXX X0XXXXX X1XXXXX X2XXXXX XX0XXXX XX1XXXX XXX0XXX XXX1XXX XXXX0XX XXXX1XX XXXXXyX XXXXXXy	y: 0.....D: language** (hexadecimal) pressure unit mbar pressure unit Torr pressure unit hPa acoustic signal off acoustic signal on venting valve not connected venting valve connected fault indicator not connected fault indicator connected y: 1.....8: number*** of active pressure transducer y: 1.....8: pressure transducer quantity
IN_ERR	fault status	0XXXX 1XXXX X0XXX X1XXX XX0XX XX1XX XXX0X XXX1X XXXX0 XXXX1	no fault at venting valve fault at venting valve no overpressure overpressure no fault at pressure transducer fault at pressure transducer no external fault external fault last interface command correct last interface command incorrect
IN_VER	version	DCP 3000 Vx.xx	software version
IN_SP_1	time interval for sending	XX:XX	mm:ss (minutes:seconds); time interval for sending
IN_SP_2	time interval for recording	XX:XX	mm:ss: (minutes:seconds); time interval for recording

Command	Operation	Response	Description
IN_SP_1y	setpoint On	XXXX.X mbar/Torr/ hPa* X.XXE±X mbar/ Torr/hPa*	y: 1.....4: setpoint On y
IN_SP_2y	setpoint Off	XXXX.X mbar/Torr/ hPa* X.XXE±X mbar/ Torr/hPa*	y: 1.....4: setpoint Off y

* unit according to preselections

** Language:

0: German

1: English

2: French

3: Italian

4: Spanish

5: Turkish

6: Korean

7: Chinese

8: Portuguese

9: Russian

A: Polish

B: Dutch

C: Japanese

D: Finnish

***numbering corresponds to order
of pressure transducers in the
configuration menu

Write commands

Command	Operation	Parameter	Description
OUT_SP_1	time interval for automatic sending of all pressure values	XX:XX alternatively: XXX	mm:ss (minutes:seconds); alternatively: sss (seconds)
OUT_SP_2	time interval for recording**	XX:XX alternatively: XXX	mm:ss (minutes:seconds); alternatively: sss (seconds)
OUT_VENT	switching venting valve	0 1 2	venting valve closed venting valve open venting until atmospheric pressure
OUT_SENSOR		1...8	external pressure transducers (if connected)
REMOTE		- 1	switch DCP 3000 off switch DCP 3000 on
OUT_SP_1y	setpoint On	XXXX.X mbar/ Torr/hPa* X.XXE±X mbar/ Torr/hPa* or X.XXE±0X mbar/Torr/hPa*	y: 1.....4: setpoint On y
OUT_SP_2y	setpoint Off	XXXX.X mbar/ Torr/hPa* X.XXE±X mbar/ Torr/hPa* or X.XXE±0X mbar/Torr/hPa*	y: 1.....4: setpoint Off y

* unit according to preselections

** When changing the time interval, recording starts anew, existing data are deleted. Time interval "0" stops recording, data are stored.

The single abbreviations of a command are separated by underscores (ASCII 5FH).

The string is terminated with <CR><LF> (ASCII 0DH, ASCII 0AH).

Pin assignment RS-232 C

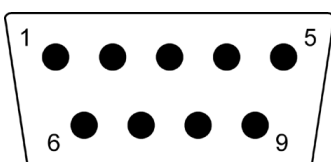

2: RxD

3: TxD

4: DTR

5: Mass

7: RTS

8: CTS

9: +5V (Bluetooth)

Troubleshooting

Fault	Possible cause	Remedy
<input type="checkbox"/> No display.	<ul style="list-style-type: none"> ➔ Power supply not plugged in (wall plug)? No power available? ➔ DCP 3000 switched off? ➔ VACUU•BUS cable of power supply not plugged in at DCP 3000? ➔ Other than above mentioned causes? 	<ul style="list-style-type: none"> ✓ Plug in power supply. Check mains fuse ✓ Switch on DCP 3000. ✓ Plug in VACUU•BUS cable at DCP 3000. ✓ Contact local distributor.
<input type="checkbox"/> Fault of pressure transducer indicated (warning triangle is flashing) or in menu "Sensors" one of the displayed sensors is flashing.	<ul style="list-style-type: none"> ➔ Pressure transducer not connected to DCP 3000? ➔ Pressure transducer or connecting cable defective? 	<ul style="list-style-type: none"> ✓ Plug in pressure transducer at the connecting jack of the DCP 3000. ✓ Replace pressure transducer or connecting cable, if necessary.
<input type="checkbox"/> In the low pressure range, the pressure reading is too high.	<ul style="list-style-type: none"> ➔ Pressure transducer contaminated? ➔ Pressure transducer decalibrated? 	<ul style="list-style-type: none"> ✓ See "Cleaning the pressure transducer". ✓ Readjust external pressure transducer.
<input type="checkbox"/> At atmospheric pressure, the pressure reading is too low.	<ul style="list-style-type: none"> ➔ Pressure transducer decalibrated? ➔ Pressure measurement with VSP 3000? 	<ul style="list-style-type: none"> ✓ Readjust external pressure transducer at atmospheric pressure. ✓ Fluctuations within the range of the measurement uncertainty. Use pressure transducer VSK 3000.
<input type="checkbox"/> Displayed pressure value is fluctuating.	<ul style="list-style-type: none"> ➔ Pressure fluctuations due to the set-up of the vacuum system? ➔ Plug of the cable to the pressure transducer not correctly plugged in? 	<ul style="list-style-type: none"> ✓ No measuring fault. Check and change set-up of the vacuum system, if necessary ✓ Plug the cable correctly into the jack at the rear of the DCP 3000.

Fault	Possible cause	Remedy
<input type="checkbox"/> Displayed pressure value is fluctuating.	<ul style="list-style-type: none"> ➔ Position of the pressure transducer VSK 3000 has been changed (e.g. from horizontal to vertical)? Fluctuation of the displayed pressure in the range of 0.2 - 0.4 mbar? ➔ Pressure transducer VSP 3000 is still in the warm-up phase? ➔ Pressure transducer VSP 3000 was exposed to a significant pressure change or a change of position. ➔ Pressure measurement with VSP 3000 at pressures above 50 mbar? 	<ul style="list-style-type: none"> ✓ Readjust pressure transducer, if exact pressure indication is required. ✓ Allow for a warm-up time of 20 minutes. ✓ Allow the pressure transducer to stabilize. ✓ Fluctuations within the range of the measurement uncertainty. Use pressure transducer VSK 3000.
<input type="checkbox"/> Pressure reading incorrect.	<ul style="list-style-type: none"> ➔ Connected pressure transducer configured incorrectly or several pressure transducers with identical VACUU•BUS addresses connected? 	<ul style="list-style-type: none"> ✓ Reconfigure pressure transducer.
<input type="checkbox"/> Second pressure transducer connected but not detected by the DCP 3000.	<ul style="list-style-type: none"> ➔ Second pressure transducer not or incorrectly configured? Both pressure transducers configured to the same address? 	<ul style="list-style-type: none"> ✓ Configure second pressure transducer.
<input type="checkbox"/> Display and warning triangle are flashing.	<ul style="list-style-type: none"> ➔ Data storage capacity in data logger function is reached? 	<ul style="list-style-type: none"> ✓ Read out data and start again, if necessary.

➔ A service manual with spare parts list and directions for repair is available on request.

👉 The service manual is intended for trained service people only.

Accessories

External pressure transducer VSK 3000 , capacitive, ceramic diaphragm sensor 810 - 0.1 Torr (1080 - 0.1 mbar)	636657
External pressure transducer VSP 3000, Pirani 7.5*10 ² - 1*10 ⁻³ Torr (1*10 ³ - 1*10 ⁻³ mbar)	636163
Vacuum gauge head MPT 100 Penning/Pirani , 1*10 ³ - 5*10 ⁻⁹ mbar	683176
Connection cable SUB-D - VACUU•BUS for MPT 100	636124
Venting valve VBM-B / KF 16 , or hose nozzle 6/10mm, 24 V=	674217
VACUU•BUS Y-type adapter	636656
VACUU•BUS extension cable , 6.6ft (2m)	612552
VACUU•BUS extension cable , 32.8ft (10m)	2618493
VACUU•BUS wall jack	636153
Serial cable RS 232C , 9-pin, Sub-D	637837
VACUU•BUS Digital-I/O-Module (e.g., fault indicator)	636228
VACUU•BUS Analog-I/O-Module (for output of vacuum values as analog voltage)	636229
PC-Software VACUU•CONTROL	692920

Conversion of VACUUBRAND valve with DIN plug to VACUUBRAND valve with VACUU•BUS plug:

VACUUBRAND-valve with DIN plug	Conversion kit valve cable with VACUU•BUS plug
Venting valve VBM, 24 V= (666817)	612554

Cleaning the pressure transducer

The vacuum gauge itself is maintenance free.

Condensate and deposits will affect the measurement results and/or the adjustment of the pressure transducer.

NOTICE

Attention: Never use a pointed or sharp-edged tool to clean the pressure transducer.

VSK 3000:

Never touch the ceramic diaphragm of the pressure transducer with hard objects.

VSP 3000:

The interior of the pressure transducer is highly sensitive!
Do not insert fingers or tools into the measuring chamber.

- Fill the measurement chamber with a solvent (e.g., benzene) and allow sufficient cleaning time. Observe all regulations concerning usage and disposal of solvents!
- Drain the solvent and dispose of in accordance with regulations. Repeat cleaning if necessary.
- Rinse the measurement chamber several times with alcohol in order to remove all solvent residues.
- Allow the pressure transducer to dry.
- Readjust the pressure transducer if necessary, see sections “Readjustment of VSK 3000”, pg. 55 / “Readjustment of VSP 3000”, pg. 57.

Calibration in the factory

Control of measuring equipment

The **VACUUBRAND DAkkS calibration laboratory** is accredited by the Deutsche Akkreditierungsstelle GmbH (national accreditation body of the Federal Republic of Germany) for the measurable variable **pressure in the pressure range from $7.5 \cdot 10^{-4}$ Torr to 975 Torr (10^{-3} mbar to 1300 mbar)** in accordance with the general criteria for the operation of testing laboratories defined in the DIN EN ISO/IEC 17025:2000 series of standards (accreditation number D-K-15154-01).

The DAkkS is signatory to the multilateral agreements of the European cooperation for Accreditation (EA) and of the International Laboratory Accreditation Cooperation (ILAC) for the mutual recognition of calibration certificates.

Rely on calibration in the VACUUBRAND calibration laboratory:

- To meet the requirements of the DIN ISO 9000ff and 10012 series of standards regarding the calibration of inspection, measuring and test equipment at specified intervals.
- To document that the vacuum gauges calibrated are traceable to national standards of the PTB (Physikalisch-Technische Bundesanstalt; German national institute for science and technology and the highest technical authority of the Federal Republic of Germany for the field of metrology and certain sectors of safety engineering).

To order **DAkkS calibration** of the DCP 3000 with external pressure transducer VSK 3000 / VSP 3000,

order number: **900215**

Readjustment of VSK 3000

NOTICE

The vacuum gauge was adjusted using factory standards, which are traceable through regular calibration in an accredited laboratory (DAkkS calibration laboratory) to the German national pressure standard. Depending on the process and/or accuracy requirements, check the adjustment and readjust if necessary. For readjustment, the device has to be adjusted both at atmospheric pressure as well as under vacuum but only if the reference pressures are known with certainty. In the range between 15 to 525 Torr (20 to 700 mbar) no adjustment is possible; "---- Torr" is displayed.

Adjustment at atmospheric pressure

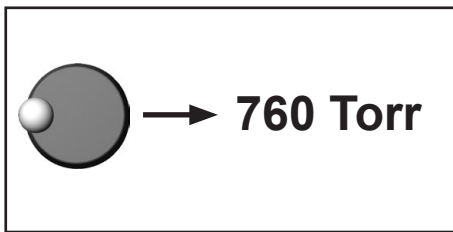

An adjustment at atmospheric pressure is only possible if the pressure is higher than 525 Torr (700 mbar).

- Vent the measurement connection of the connected external gauge head VSK 3000. Make sure that the pressure transducer is at atmospheric pressure.
- In "Configuration" menu, select program "Adjustment" at the DCP 3000.
- Use the selection knob to adjust the reading to the current atmospheric pressure.
- Press the selection knob to confirm.

Note: To determine the actual atmospheric pressure, use an accurate barometer or get accurate reading from the weather service, or a nearby airport or other reliable source (taking into account the difference in altitude between the source and the laboratory).

Adjustment under vacuum

0 Torr

An adjustment under vacuum is only possible if the pressure is lower than 15 Torr (20 mbar) absolute.

- ➔ Evacuate the measurement connection of the connected external gauge head VSK 3000 to a pressure < 0.1 Torr (mbar) (e.g., by applying a good two-stage rotary vane pump).
- ➔ In "Configuration" menu, select program "Adjustment" at the DCP 3000.
- ☞ The reading is automatically adjusted to "zero".
- ➔ Press the selection knob to confirm.

Note: Adjustment under vacuum with an actual pressure higher than 0.1 Torr (mbar) reduces the accuracy of the measurement. If the pressure is significantly higher than 0.1 Torr (mbar), adjustment to a reference pressure is recommended.

Adjustment at a reference pressure

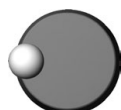

0...15 Torr

Instead of adjustment under vacuum to a pressure < 0.1 Torr (mbar), adjustment to a precisely known reference pressure within the range of 0..... 15 Torr (20 mbar) is possible.

- ➔ Evacuate the measurement connection of the connected external gauge head VSK 3000 to a pressure within 0 15 Torr (0.....20 mbar).
- ➔ In "Configuration" menu, select program "Adjustment" at the DCP 3000.
- ☞ The reading is automatically adjusted to "zero".
- ➔ Use the selection knob to adjust the display to the reference pressure at the vacuum line within the range of 0 15 Torr (0.....20 mbar).
- ➔ Press the selection knob to confirm.

Note: The accuracy of the value of the reference pressure will directly affect the accuracy of the adjustment. If the nominal ultimate vacuum of a diaphragm pump is used as reference vacuum, the accuracy of the controller might be doubtful. The diaphragm pump may not achieve the specified value (due to condensate, poor condition, failure of valves or diaphragm, leaks).

Readjustment of VSP 3000

NOTICE

The vacuum gauge head VSP 3000 was adjusted using factory standards, which are traceable through regular calibration in an accredited laboratory (DAkkS calibration laboratory) to the German national pressure standard. Depending on the process and/or accuracy requirements, check the adjustment and readjust if necessary. For re-adjustment, the device has to be adjusted both at atmospheric pressure as well as under vacuum but only if the reference pressures are known with certainty.

- For adjustment, install the pressure transducer VSP 3000 in the same orientation in which it will be operated later at the application.
- Allow the pressure transducer a period of minimum 20 minutes to preheat.
- ☞ During the first 20 minutes after having connected the pressure transducer VSP 3000 to a energized vacuum gauge DCP 3000, adjustment of the VSP 3000 is not possible.

"---- Torr" is displayed if adjustment is not possible in the actual pressure range.

Adjustment at atmospheric pressure

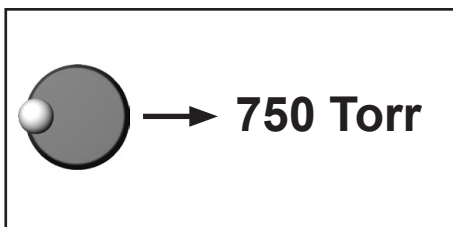

An adjustment at atmospheric pressure is only possible in the upper pressure range.

- Vent the measurement connection of the VSP 3000 pressure transducer. Make sure that the measurement connection of the VSP 3000 is at atmospheric pressure. Allow the pressure transducer a **minimum of 20 minutes** to preheat at this pressure.

- ➔ In "*Configuration*" menu, select program "*Adjustment*" at the DCP 3000.
- ➔ The reading is automatically adjusted to "750 Torr" ("1000 mbar"). This value is fixed and cannot be changed.
- ➔ Press the selection knob to confirm.

Adjustment under vacuum

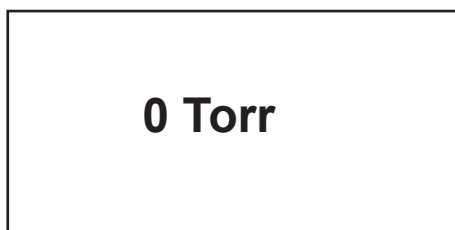

An adjustment under vacuum is only possible in the lower pressure range.

- ➔ Evacuate the measurement connection of the VSP 3000 pressure transducer preferably below 7.5×10^{-4} Torr (1×10^{-3} mbar), e.g., by applying a high vacuum pump. Allow the pressure transducer a **minimum of 20 minutes** to preheat at this pressure.
- ➔ In "*Configuration*" menu, select program "*Adjustment*" at the DCP 3000.
- ➔ The reading is automatically adjusted to "zero". This value is fixed and cannot be changed.
- ➔ Press the selection knob to confirm.

Repair - Maintenance - Return - Calibration

IMPORTANT

Every employer (user) is held responsible for the health and safety of his employees. This also applies to service personnel performing repair, maintenance, return or calibration.

The **health and safety clearance form** informs the contractor about any possible contamination of the device and forms the basis for the risk assessment.

In case of devices which have been in contact with biological substances of risk level 2 contact the VACUUBRAND service absolutely before dispatching the device. These devices have to be completely disassembled and decontaminated by the user prior to shipment. Do not return devices which have been in contact biological substances of risk level 3 or 4. These devices cannot be checked, maintained or repaired. Also decontaminated devices must not returned to VACUUBRAND due to a residual risk.

The same conditions apply to on-site work.

No repair, maintenance, return or calibration is possible unless the correctly completed health and safety clearance form is returned. Devices sent are rejected if applicable. Send a completed copy of the **health and safety clearance form** to us in advance. The declaration must arrive before the equipment. Enclose a second completed copy with the product.

Remove all components from the device that are no original VACUUBRAND components. VACUUBRAND will not be responsible for lost or damaged components that are no original components.

Drain the device completely of fluids and residues. Decontaminate the device. Close all openings airtight especially if using substances hazardous to health.

To expedite repair and to reduce costs, please enclose a detailed description of the problem and the product's operating conditions with every product returned.

If you do not wish a repair on the basis of our **quotation**, the device may be returned to you disassembled and at your expense.

In many cases, the components must be cleaned in the factory prior to repair.

For cleaning we use an environmentally friendly water based process. Unfortunately the combined attack of elevated temperature, cleaning agent, ultrasonic treatment and mechanical stress (from pressurised water) may result in damage to the paint. Please mark in the health and safety clearance form if you wish a repaint at your expense just in case such a damage should occur. We will also replace parts for cosmetic reasons at your request and at your expense.

Before returning the device

Pack the device properly, if necessary, please order original packaging materials at your costs.

Mark the package completely

Enclose the completed health and safety clearance form.

Notify the carrier of any possible contamination if required.

Scrapping and waste disposal

Dispose of the equipment and any components removed from it safely in accordance with all local and national safety and environmental requirements. Particular care must be taken with components and waste oil which have been contaminated with dangerous substances from your processes. Do not incinerate fluoroelastomer seals and O-rings. You may authorize us to dispose of the equipment **at your expense**. Otherwise we return the device at your expense.

Warranty

VACUUBRAND shall be liable for insuring that this product, including any agreed installation, has been free of defects at the time of the transfer of risk.

VACUUBRAND shall not be liable for the consequences of improper handling, use, servicing or operation of this product or the consequences of normal wear and tear of wearing parts such as diaphragms, seals, valves, vanes, condensers, oil and the breakage of glass or ceramic parts, for the consequences of chemical, electrochemical or electrical influences or the failure to follow the instructions in this manual.

Claims for defects against VACUUBRAND shall be limited to one year from delivery. The same shall apply to claims for damages irrespective of legal grounds.

For further information on general terms and conditions refer to www.vacuubrand.com.

Health and safety clearance form

1. Device (Model):

2. Serial no.:

3. Reason for return / malfunction:

.....

4. Has the device been used in a copper process step (e.g., semiconductor production): yes no

5. Substances (gases, liquids, solids, biological material, e. g. bacteria, viruses) in contact with the device / which have been pumped:

.....

.....

.....

6. Risk level of the used biological material: none 1 2* 3** 4**

* Contact the VACUUBRAND service absolutely before dispatching the device.

** Devices which have been in contact with biological substances of risk level 3 or 4 cannot be checked, maintained or repaired. Also decontaminated devices must not returned to VACUUBRAND due to a residual risk.

7. Radioactive contamination: yes no

8. Prior to return to the factory the device has been decontaminated: yes no

Description of the decontamination method and the test / verification procedure:

.....

.....

9. All parts of the device are free of hazardous, harmful substances: yes no

10. Protective measures required for service staff:

.....

11. If the paint is damaged, we wish a repaint or a replacement of parts for reason of appearance (repaint and replacement at customer's expense): yes no

12. Legally binding declaration

We assure for the returned device that all substances, which have been in contact with the device are listed in section 5 and that the information is complete and that we have not withheld any information. We declare that all measures - where applicable - have been taken listed in section "Repair - Maintenance - Return - Calibration". By our signature below, we acknowledge that we accept liability for any damage caused by providing incomplete or incorrect information and that we shall indemnify VACUUBRAND from any claims as regards damages from third parties. We are aware that as expressed in § 823 BGB (Public Law Code of Germany) we are directly liable for injuries or damages suffered by third parties, particularly VACUUBRAND employees occupied with handling/repairing the product. Shipping of the device must take place according to regulations.

Name: Signature:

Job title: Company's seal:

Date:

Release for repair grant by VACUUBRAND (date / signature):.....
Protective measures: Protective gloves, safety goggles Hood External cleaning





**EG-Konformitätserklärung
EC Declaration of Conformity
Déclaration CE de conformité**

Hersteller / Manufacturer / Fabricant:

VACUUBRAND GMBH + CO KG · Alfred-Zippe-Str. 4 · 97877 Wertheim · Germany

Hiermit erklärt der Hersteller, dass das Gerät konform ist mit den Bestimmungen der Richtlinien:

Hereby the manufacturer declares that the device is in conformity with the directives:

Par la présente, le fabricant déclare, que le dispositif est conforme aux directives:

2004/108/EG, 2006/95/EG: gültig bis / valid until / valable jusqu'au 19.04.2016

2014/30/EU, 2014/35/EU: gültig ab / valid from / valable à partir du 20.04.2016

94/9/EG: gültig bis / valid until / valable jusqu'au 19.04.2016 (nur / only / seulement DCP 3000 / DCP 3000 + VSK 3000)

2014/34/EU: gültig ab / valid from / valable à partir du 20.04.2016 (nur / only / seulement DCP 3000 / DCP 3000 + VSK 3000)

Vakuum-Messgerät / Vacuum gauge / vacuomètre

Typ / Type / Type: DCP 3000 / DCP 3000 + VSK 3000 / DCP 3000 + VSP 3000 / DCP 3000 + MPT 100

Artikelnummer / Order number / Numéro d'article: 683171 / 683170 / 683190 / 683175

Seriennummer / Serial number / Numéro de série: Siehe Typenschild / See rating plate / Voir plaque signalétique

Angewandte harmonisierte Normen / Harmonized standards applied / Normes harmonisées utilisées:

DIN EN 61326-1:2013, DIN EN 61010-1:2011, IEC 61010-1:2010 (Ed. 3)

nur / only / seulement DCP 3000 / DCP 3000 + VSK 3000: DIN EN 1127-1:2011, DIN EN 13463-1:2009

Bevollmächtigter für die Zusammenstellung der technischen Unterlagen / Person authorised to compile the technical file / Personne autorisée à constituer le dossier technique:

Dr. J. Dirscherl · VACUUBRAND GMBH + CO KG · Alfred-Zippe-Str. 4 · 97877 Wertheim · Germany

Wertheim, 14.04.2016

Ort, Datum / place, date / lieu, date

(Dr. F. Gitmans)

Geschäftsführer / Managing director / Gérant

ppa.

(Dr. J. Dirscherl)

Technischer Leiter / Technical Director / Directeur technique



VACUUBRAND GMBH + CO KG

Alfred-Zippe-Str. 4 · 97877 Wertheim

T +49 9342 808-0 · F +49 9342 808-5555

info@vacuubrand.com

www.vacuubrand.com

Certificate



Certificate no.

CU 72091199 01

License Holder:

VACUUBRAND GMBH + Co. KG
Alfred-Zippe-Str. 4

97877 Wertheim
Germany

Manufacturing Plant:

VACUUBRAND GMBH + Co. KG
Alfred-Zippe-Str. 4

97877 Wertheim
Germany

Test report no.: USA-DS 30981596 001

Client Reference: M. von Przychowski

Tested to: UL 61010-1:2004 R10.08
CAN/CSA-C22.2 .61010-1:2004

Certified Product: Measurement and Control Device for Vacuum**License Fee - Units****Model Designation:**

Main Unit: 1) CVC 3000, CVC 3000E, CVC 3000E ARB C3,
DCP 3000, DCP 3000E

Valves and Sensors: 2) VKW-B, 3) VB M-B,
4) Liquid level sensor (699908),
5) VV-B 6, 6) VV-B 6C,
7) VV-B 15C, 8) VSK 3000

Rated Voltage DC: 1-3) 24V; 4) 8-30V; 5-7) 24V; 8) 6-30V

Rated Current: 1) 1.25A; 4) 5mA (max.); 8) 5mA

Rated Power: 1) 3.4W; 2) 2W; 3) 4W; 5) 8W; 6) 5.5W; 7) 12W

Protection Class: III

Appendix: 1

Licensed Test mark:



Signature

Dipl.-Ing. M. Glagla
QA Certification Officer

Date of Issue
(day/mo/yr)

17/06/2009

TUV Rheinland of North America, Inc., 12 Commerce Road, Newtown, CT 06470, Tel (203) 426-0888 Fax (203) 426-4009

This certificate is only valid for pumps with the respective mark (Licensed Test mark) on the pump rating plate.

Disclaimer: Our technical literature is only intended to inform our customer. The applicability of general empirical values and results obtained under lab conditions to your specific operations depends on a number of factors beyond our control. It is, therefore, strictly the users' responsibility to very carefully check the application of these data to their specific requirements. No claims arising from the information provided in this literature will, consequently, be entertained.



Alfred-Zippe-Str. 4 · 97877 Wertheim / Germany
T +49 9342 808-0 · F +49 9342 808-5555
info@vacuubrand.com · www.vacuubrand.com

VACUUBRAND GMBH + CO KG
- Technology for Vacuum Systems -
© 2016 VACUUBRAND GMBH + CO KG Printed in Germany