



本商品はカナダ規格(CSA)取得品です。
(Canadian Standards Association)

Instruction Manual (Original Instructions)

Oilfree Scroll Vacuum Pump

ISP-50

This instruction manual includes very important warnings, cautions and operating procedure in order to operate this pump safely and efficiently.
Be sure to read this instruction manual thoroughly and fully understand before operation.
After reading it, store it in a convenient place for immediate and future reading.

※Before use, be sure to fill in the blank spaces below for future repair and after-service.

Serial No.
Who sold it to you
Purchase date
When you began operation

Declaration of Conformity

We , ANEST IWATA Corporation

3176, Shinyoshida-cho, Kohoku-ku, Yokohama 223-8501, Japan

declare in our sole responsibility that the products

Type : Scroll Vacuum Pump

Models :

ISP-50

1-phase , 100V class

100V , 50/60Hz

115V , 60Hz

Note: 1-phase motor provides thermal protector.

to which this declaration applies, complies with these normative documents :

2006/42/EC : Machinery Directive

EN 1012-2:1996 : Compressors and Vacuum Pumps-Safety

Requirements, Part 2: Vacuum Pumps

This Declaration is based on :

Third party testing, performed by the Notified Body

TUV Rheinland Product Safety GmbH - Am Grauen Stein - D-51105 Köln



Tamotsu Fujioka ,

Manager of Vacuum Pump Dept.

Sep. 1. 2009_YOKOHAMA

Date and Place

Important information

Important information

Be sure to read this instruction manual to understand how to operate equipment correctly. Only operators, who fully understand warnings, cautions and instructions, are to operate the equipment. Improper operation (mishandling) can cause serious bodily injury, death, fire or explosion.





Store this manual in a convenient place for immediate and future reference.



◆ Regarding safety

- The safety instructions given in this manual are the minimum operating requirements. Follow all national or municipal laws and regulations pertaining to fire, electricity, and other safety regulations, as well as corporate regulations.
- Pay special attention to items which are shown by the below marks and symbols.
- Symbols and marks have the following meanings.

Examples of marks

	WARNING	Indicates a potentially hazardous situation which, if not avoided, may result in serious injury or loss of life.
	CAUTION	Indicates a potentially hazardous situation which, if not avoided, may result in minor or moderate injury or property damage.

Examples of symbols

	Indicates [Beware]. We will explain briefly in or near the symbol. (The example on the left is [Beware of electric shock]).
	Indicates [Prohibited action]. We will explain briefly in or near the symbol. (The example on the left is [Do not touch]).
	Indicates [Required action]. We will explain briefly in or near the symbol. (The example on the left is [Be sure to ground]).

* We shall not be responsible for any injury or damage caused by disregard of warnings, cautions or instructions.

Supplementary notes











Important	Indicates notes which we ask you to observe. They are helpful to achieve full performance and functionality of the equipment.
------------------	---

For safe operation

Below is very important information about how to safely operate the equipment. Before operation, be sure to read and fully understand the contents.













WARNING

 Be careful about lifting	Danger of cargo collapse Hold the bottom of the product (ISP-50 mass 12kgs) firmly, when installing vacuum pump. If not, it can cause damage, failure or bodily injury from falling vacuum pump, or by being caught between vacuum pump and other material.	 Avoid moisture	Danger of electric shock Install in an area which is not exposed to moisture such as rain or steam. If moisture comes into and tact with the electric source connection, it can cause fire or bodily injury due to short-circuit or electric shock.
 Install at a safe site	Danger of explosion, fire and accident Install in an area free from explosive, flammable or corrosive substances. If not, it can cause explosion, fire or accident.	 Ask qualified electrician	Danger of short-circuit and electric shock Ask a qualified electrician to perform electric wiring. If not, short-circuit or electric shock can cause fire or bodily injury.
 Turn off electric source	Danger of electric shock and entanglement Be sure to turn off electric source on building site before wiring. If not, it can cause electric shock or bodily injury due to turning objects.	 Install overcurrent protective device	Danger of accident, fire and failure Be sure to install protective device to protect circuitry. We recommend an overcurrent protective device (rated 15A) to protect branch circuit. If equipment is not stopped in an emergency, it can cause accident, fire or failure.
 Install emergency stop switch	Danger of accident, fire or failure Be sure to install an electric source emergency stop switch (or protective device that can urgently stop). If equipment is not stopped in an emergency, it can cause accident, fire or failure.	 Install short circuit protective device	Danger of fire and electric shock Install short circuit protective device. If not, it can cause bodily injury due to fire or electric shock.
 Install motor protective circuit breaker to protect motor	Danger of electric fire and electric shock Install motor protective circuit breaker to protect motor. If not, it can cause bodily injury due to electric fire or electric shock. If you have any questions about the selection of protective devices, contact either the dealer who sold it to you or us.	 Be careful about wiring	Danger of short-circuit and electric shock We recommend an electric wire of larger than 2mm ² (more than rated 10A,) cross section area for electric wire (including grounding wire.). Be careful to avoid voltage drop considering local situation. If not, it can cause a short-circuit fire and may result in bodily injury from electric shock.

For safe operation















WARNING

 <p>Be careful about insertion</p>	<p>Danger of short-circuit and electric shock</p> <p>Insert the connector to the receptacle surely by using an electric wire with an appropriate connector. If not, it can cause short-circuit fire or bodily injury from electric shock due to looseness or disconnection.</p>	 <p>With a thermal protector [Only single-phase motor]</p>	<p>Danger of restart</p> <p>Be sure to switch off electric source before maintenance or inspection. Single-phase motor has a thermal protector. Vacuum pump restarts become cool without warning after vacuum pump.</p>
 <p>Be sure to ground</p>	<p>Danger of electric shock</p> <p>Connect grounding wire to electric source. If not, it can cause bodily injury from electric shock.</p>	 <p>Never evacuate hazardous gas</p>	<p>Danger of explosion and ignition</p> <p>Do not evacuate gas which is hazardous to humans or explosive, flammable, or corrosive. Do not evacuate with substances containing chemicals, solvents, and powders. If done, it can cause failure or bodily injury by gas, explosion or ignition.</p>
 <p>Avoid foreign matter</p>	<p>Danger of entanglement and foreign matter dispersal</p> <p>Never put finger or foreign matter into air hole of fan cover, air hole of motor or clearance between FS(1) and FS(2) cooling fins. If done, it can cause bodily injury from entanglement with turning section, or foreign matter dispersal.</p>	 <p>Never alter</p>	<p>Danger of electric shock and entanglement</p> <p>Do not remove or alter safeguards or insulation parts. If done, it can cause bodily injury from electric shock or turning section and it can cause deteriorated performance and operating lifetime, and invalidate guarantee.</p>
 <p>Change after vacuum pump is stopped</p>	<p>Danger of failure and bodily injury</p> <p>Change air-flush port only after vacuum pump is stopped. If you change it during vacuum pump operation, it can cause vacuum pump failure and bodily injury.</p>	 <p>Conduct periodical maintenance and inspection</p>	<p>Danger of failure and bodily injury</p> <p>Conduct periodical maintenance and inspection. If not, it can cause insufficient performance, failure of vacuum pump, and bodily injury.</p>
 <p>Be careful about high temperature</p>	<p>Danger of burns</p> <p>Conduct maintenance and inspection only after vacuum pump becomes cool enough. Maintenance and inspection soon after vacuum pump stops can cause burn injury.</p>	 <p>Turn off electric source</p>	<p>Danger of electric shock</p> <p>Be sure to conduct maintenance and inspection after you turn off electric source. If not, it can cause bodily injury from electric shock or turning object.</p>
 <p>Ask specialist to perform repairs</p>	<p>Danger of accident, failure and shorter operating lifetime</p> <p>Ask specialist to perform repairs. Defective repairs can cause accident, failure or shorter operating lifetime.</p>		

For safe operation







CAUTION

 Use at designated temperature	Danger of overheating Operate at ambient temperature of 5°C~40°C. Operating at a temperature range other than that designated can cause accident, failure or bodily injury such as burns due to overheating.	 Pay attention to ventilation	Danger of overheating Install in a well-ventilated area. Poor ventilation can disrupt cooling and cause accident, failure or bodily injury such as burns since this vacuum pump is an air-cooled type. Do not block inlet and outlet of cooling air with obstruction. (Separate inlet side of the cooling air from obstruction or wall by 1cm or more, and separate outlet side by 10cm or more)
 Avoid dust	Danger of dust Be sure site is free from dust. Sucking in of dust can cause failure.	 Install on a solid, level floor	Danger of unbalance Be sure to install on solid and level floor (less than 5° inclination). Uneven installation can cause failure and movement of vacuum pump. If installation floor is unstable, fix pump base with 4-φ9 holes of pump leg (ISP-50).
 Avoid direct sunlight	Danger of overheating Install where equipment is not exposed to direct sunlight. Vacuum pump exposed to direct sunlight can overheat, resulting in failure.	 Check voltage	Motor burnout Before doing any wiring, check electric source and voltage. ISP-50-SV1 is AC100V class. <u>Voltage can not be changed.</u> Check your electric source, voltage, and wire correctly to receptacle. Improper wiring and incorrect voltage can cause motor burnout.
 Inspect cause of problem	Danger of problem recurrence and failure If protective device or thermal protector activates, be sure to turn off electric source and inspect causes to solve the problem. Do not operate until problem is solved. Operation while problem is left unsolved can cause problem recurrence and failure.	 Remove blank flange	Danger of exhaust disruption Remove blank flange from inlet and outlet. Operation with blank flange being fitted can disrupt exhaust or cause blank flange to fly by exhaust impetus, resulting in accident, failure, or bodily injury from contact with flying objects.
 Prevent foreign matter from entering	Danger of foreign matter entering inlet When checking turning direction, be careful not to enter foreign matter into an inlet. Foreign matter entering inlet can cause failure.	 Check fan	Danger of overheating Check that cooling fan is turning and cooling air is flowing. If not, it can cause accident, failure or bodily injury such as burns due to overheating.
 Pay attention to exhaust resistance	Danger of exhaust disruption When connecting exhaust piping to vacuum pump and when combining piping with another vacuum pump, pay attention to piping size and length so that it does not cause exhaust resistance. Exhaust resistance can disrupt air flow, resulting in failure and overcurrent.	 Start or stop after closing isolation valve	Danger of vacuum break and pollution Be sure to close isolation valve between vacuum pump and vacuum system (chamber) during startup and stop. Start-up or stop with isolation valve in the open position can draw back gas and debris attached to inside of pump to vacuum chamber due to pressure differential, resulting in vacuum break and pollution on vacuum chamber side.

For safe operation



CAUTION

 Open air inlet	Danger of abnormal sound and failure Open inlet to atmosphere for about 5 seconds before restarting vacuum pump. If not, it can unbalance temperature inside vacuum pump, resulting in failure.	 Beware temperature of intake gas	Danger of exceeding permissible temperature of intake gas If intake gas temperature is over 50°C, be sure to install a chiller or trap between vacuum pump and vacuum chamber so that gas intake temperature of vacuum pump keeps below 50°C. If not, vacuum pump temperature can increase, resulting in failure.
 Operate while opening air-flush port	Danger of remaining moisture When evacuating moisture, be sure to open air-flush port (air-flush operation). If you evacuate vapor while air-flush port is closed, condensed moisture will remain inside vacuum pump and cause failure.	 Caution after exhausting vapor	Danger of insufficient vapor exhaust After evacuating vapor, do air-flush operation for at least one hour. If you close air-flush port or stop vacuum pump soon after evacuating vapor, condensed water will remain inside vacuum pump which will cause failure.
 Beware of intake gas volume	Danger of exceeding permissible intake gas volume When sending N ₂ gas or dry air into air-flush port, pressure should be the same as atmospheric pressure and flow rate should be less than 4L/min. If not, it can increase pressure inside vacuum pump, resulting in failure.		

Where to attach warning stickers

Where to attach warning stickers

Always keep warning stickers clean and legible. If they become dirty or detached, replace them with new ones. If you need replacement stickers, contact the dealer who sold the vacuum pump to you.

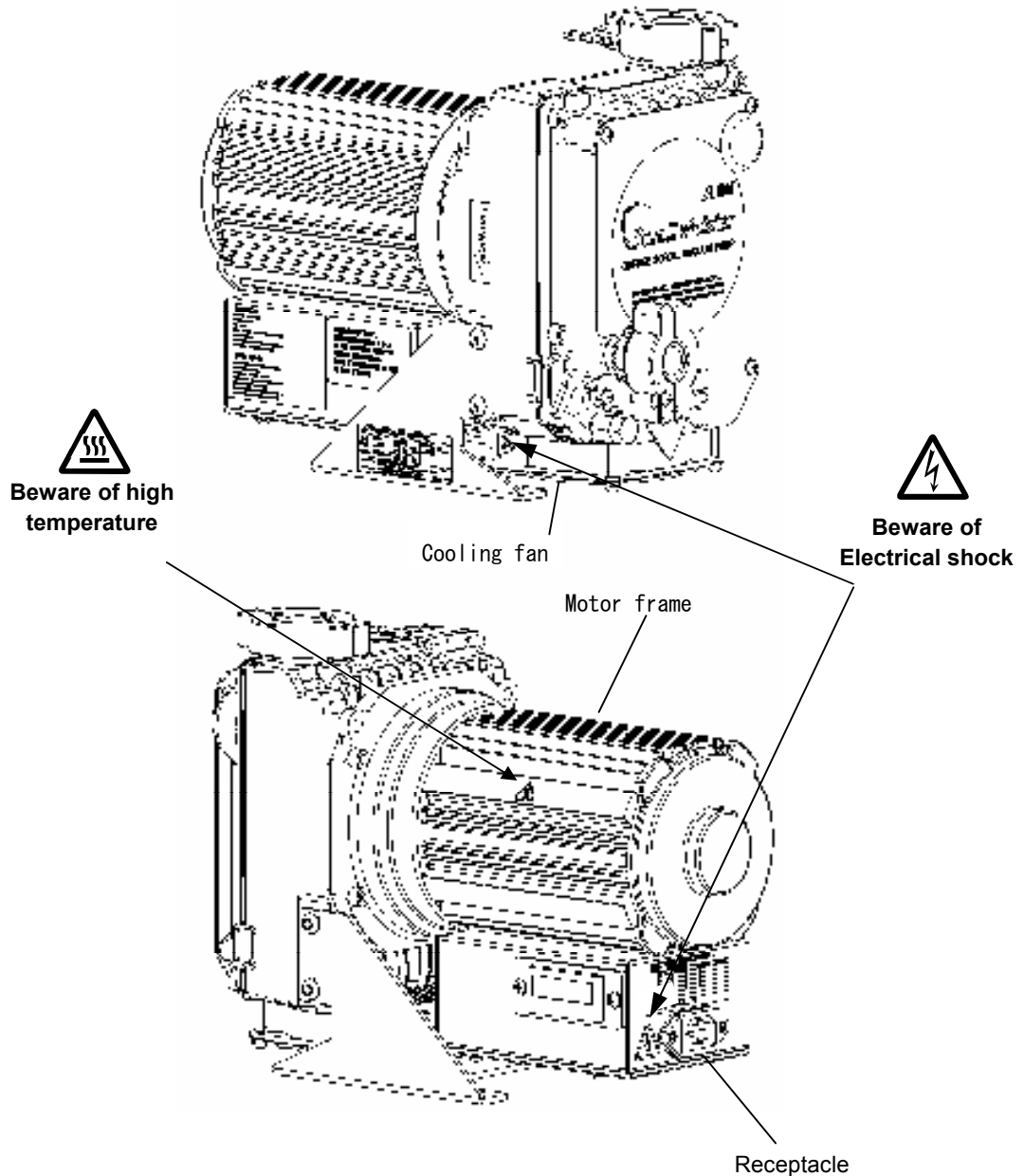

Contents

Important information	1
Important information	1
For safe operation	2
Contents	7
1. Before use	8
1.1 Check the product	8
2. Name and structure of each section	11
3. Installation	12
3.1 Wiring	13
3.2 Test operation	17
3.3 Connection to vacuum system (chamber)	18
4. Operation	19
4.1 Standard operation	21
4.1.1 Start-up	21
4.1.2 Shut-down	21
4.2 Air-flush operation	22
4.2.1 Preparation	22
4.2.2 Start-up and shut-down	23
4.2.3 When returning to standard operation	23
5. Maintenance and inspection	24
5.1 Daily maintenance and inspection	24
5.2 Maintenance	25
6. Problems and remedies	26
7. Disposal	27
8. Specifications	28
8.1 Specifications	28
8.1.1 ISP-50	28
8.2 Dimensions	29
8.2.1 ISP-50-SV1	29
8.3 Performance data	30

1. Before use

1.1 Check the product

- Check that the package is right-side-up before opening.
- Check that the model of the product is the same as the one you ordered.

How to read model name

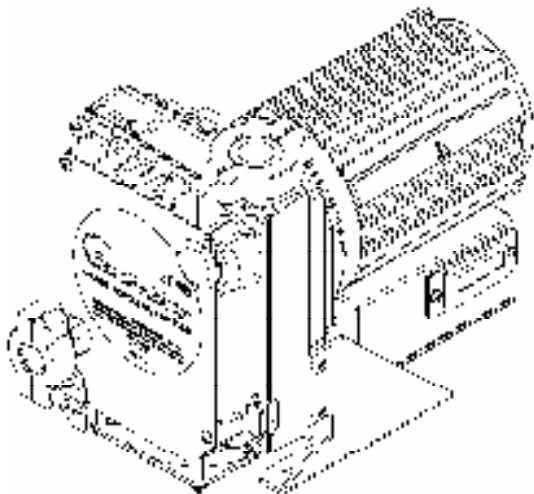
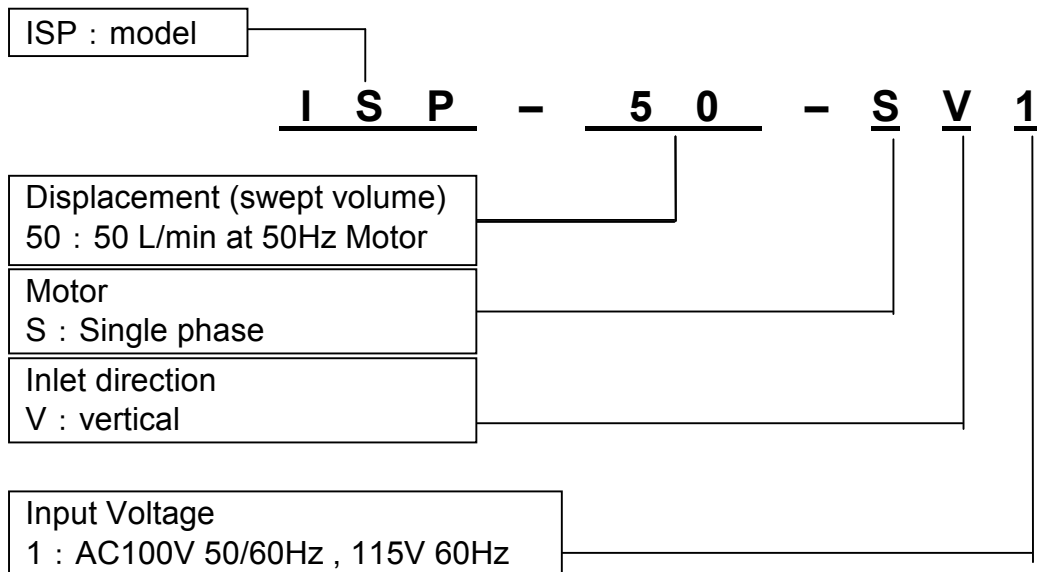

ISP-50-SV1/SV2

- **Check that there is no damage.**

If there is any damage, contact either the dealer who sold it to you or us.

- **Check the following accessories.**

Instruction manual (this one)

(Instruction manuals written by official languages except English must be sent to a customer along with the delivery of a product.)

Air-muffler for air-flush

(ISP-50 is attached to outlet flange.)

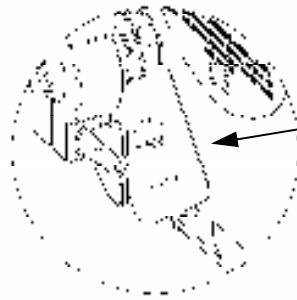

Vinyl bag

(Air muffler is contained inside)

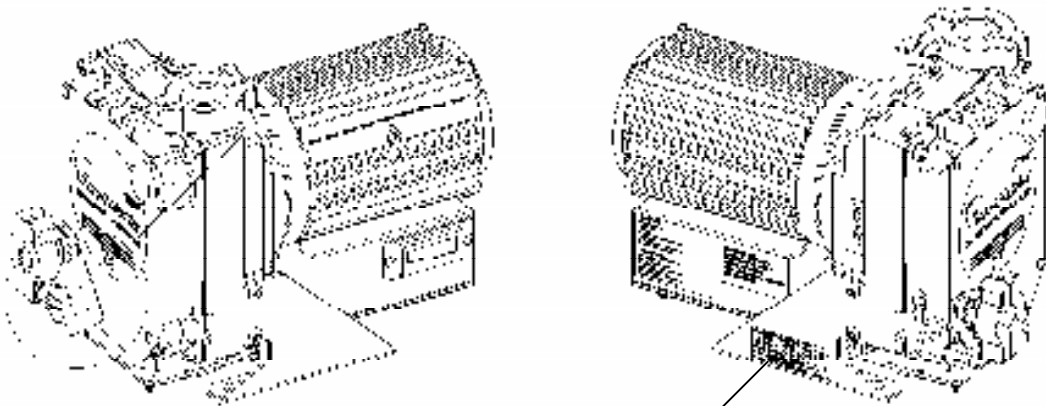

OILFREE SCROLL VACUUM PUMP				CE	
 LR104996	MODEL	ISP-50		MOTOR 0.1 kW	
	CYCLES	Hz	50	60	SERIAL NO.
	DISPLACEMENT	$\frac{L}{min}$	50	60	
Manufacturer	ANEIST IWATA Corporation 3176 shiroyashida Kohoku, Yokohama 223-8501 JAPAN			YEAR	
Local agent	ANEIST IWATA Europe S.R.L. Corso Vigevanino, 46-10155 Terni, ITALY			MADE JAPAN	

Serial number

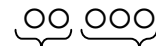

Alphabetic Numeric

Year of manufacture

※Please prepare electric wires, crimp-style terminal, protective devices, piping to inlet, and piping from outlet on customer side.

Open package



WARNING

Danger of cargo collapse

Hold the bottom of the product (ISP-50 mass 12kgs) firmly, when installing vacuum pump.

If not, it can cause damage, failure or bodily injury from falling vacuum pump, or by being caught between vacuum pump and other material.



Be careful about lifting

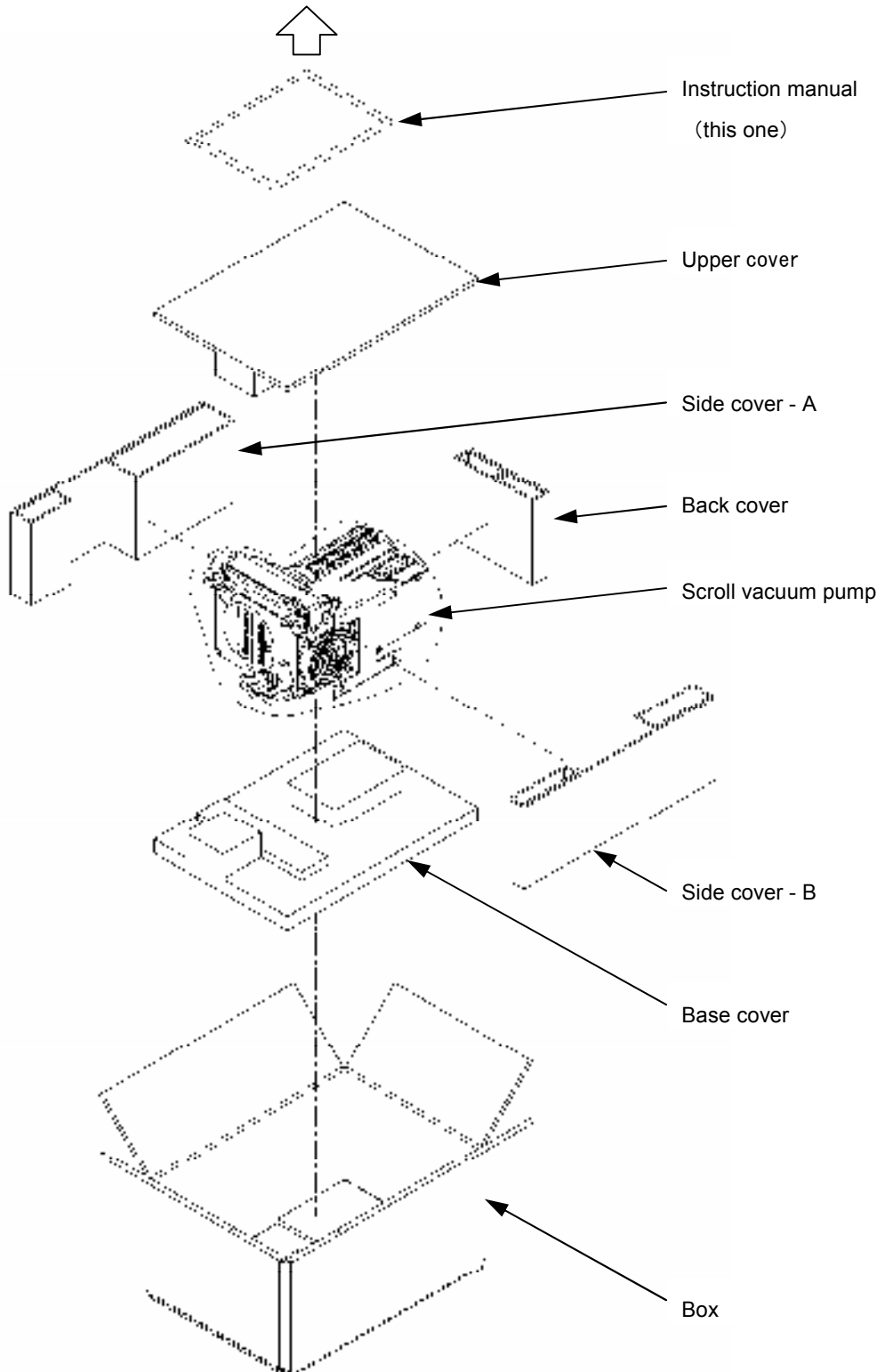

※This product does not come with an electric wire.

2. Name and structure of each section

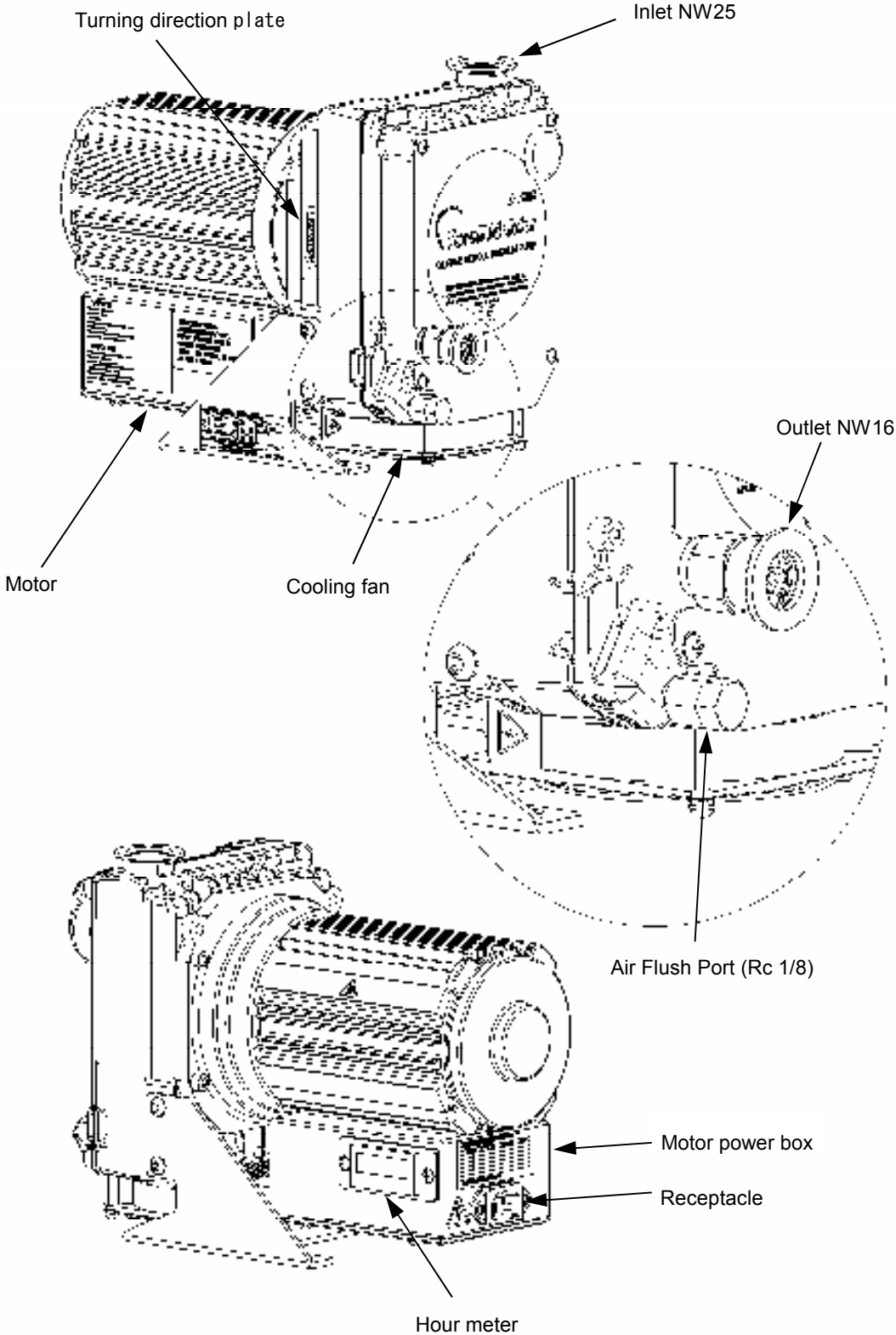

• ISP-50

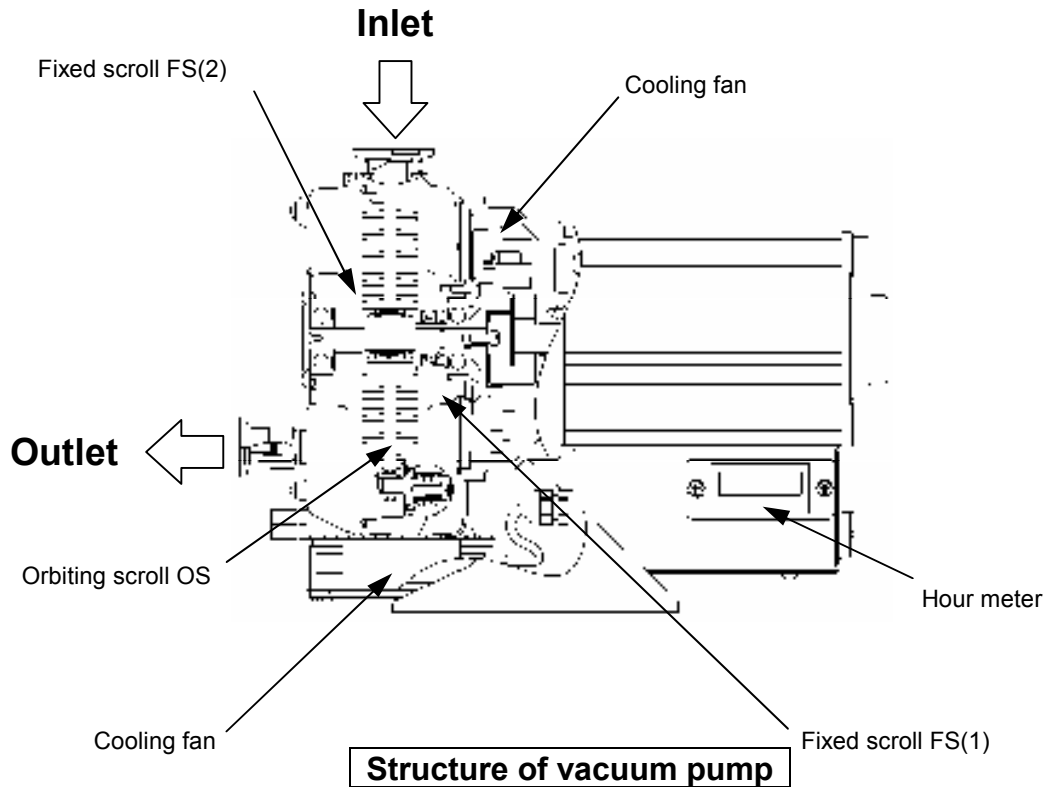







3. Installation

 WARNING	
Danger of electric shock Install in an area which is not exposed to moisture such as rain or steam. If moisture comes into and tact with the electric source connection, it can cause fire or bodily injury due to short-circuit or electric shock.	 Avoid moisture
Danger of explosion, fire or accident Install in an area free from explosive, flammable or corrosive substances. If not, it can cause explosion, fire or accident.	 Install at a safe site







 CAUTION			
Danger of overheating Operate at ambient temperature of 5°C~40°C. Operating at a temperature range other than that designated can cause accident, failure or bodily injury such as burns due to overheating.	 Use at designated temperature		
Danger of overheating Install in a well-ventilated area (refer to below chart). Poor ventilation can disrupt cooling and cause accident, failure or bodily injury such as burns since this vacuum pump is an air-cooled type. Do not block inlet and outlet of cooling air with obstruction. (Separate inlet side of the cooling air from obstruction or wall by 1cm or more, and separate outlet side by 10cm or more)	 Pay attention to ventilation		
<table border="1" style="margin: auto;"> <tr> <td style="padding: 5px;">Necessary ventilated air volume</td> </tr> <tr> <td style="padding: 5px;">Over 2 m³/min</td> </tr> </table>		Necessary ventilated air volume	Over 2 m³/min
Necessary ventilated air volume			
Over 2 m³/min			





<p>Danger of dust Be sure site is free from dust. Sucking in of dust can cause failure.</p>	 Avoid dust
<p>Danger of unbalance Be sure to install on solid and level floor (less than 5° inclination). Uneven installation can cause failure and movement of vacuum pump. If installation floor is unstable, fix pump base with 4-φ9 holes of pump leg (ISP-50).</p> 	 Install on a solid, level floor
<p>Danger of overheating Install where equipment is not exposed to direct sunlight. Vacuum pump exposed to direct sunlight can overheat, resulting in failure.</p>	 Avoid direct sunlight

Important

When building vacuum pump into vacuum system, pay attention to space for maintenance, ambient temperature and piping. Be sure to fix vacuum pump on solid and level floor. If you have any questions, contact the dealer who sold it to you or us.

3.1 Wiring

 WARNING	
<p>Danger of short-circuit and electric shock Ask a qualified electrician to perform electric wiring. If not, short-circuit or electric shock can cause fire or bodily injury.</p>	 Ask qualified electrician
<p>Danger of electric shock and entanglement Be sure to turn off electric source on building site before wiring. If not, it can cause electric shock or bodily injury due to turning objects.</p>	 Turn off electric source
<p>Danger of accident, fire and failure Be sure to install protective device to protect circuitry. We recommend an overcurrent protective device (rated 15A) to protect branch circuit. If equipment is not stopped in an emergency, it can cause accident, fire or failure.</p>	 Install overcurrent protective device
<p>Danger of accident, fire or failure Be sure to install an electric source emergency stop switch (or protective device that can urgently stop). If equipment is not stopped in an emergency, it can cause accident, fire or failure.</p>	 Install emergency stop switch
<p>Danger of fire and electric shock Install short circuit protective device. If not, it can cause bodily injury due to fire or electric shock.</p>	 Install short circuit protective device

<p>Danger of fire and electric shock (refer to chart 1 on page 15)</p> <p>Install motor protective circuit breaker to protect motor If not, it can cause bodily injury due to electric fire or electric shock. If you have any questions about the selection of protective devices, contact either the dealer who sold it to you or us.</p>	 <p>Install motor protective circuit breaker to protect motor</p>
<p>Danger of short-circuit and electric shock</p> <p><u>We recommend an electric wire of larger than 2mm² (more than rated 10A,) cross section area for electric wire (including grounding wire.)</u> Be careful to avoid voltage drop considering local situation. If not, it can cause a short-circuit fire and may result in bodily injury from electric shock.</p>	 <p>Be careful about wiring</p>
<p>Danger of short-circuit and electric shock</p> <p>Insert the connector to the receptacle surely by using an electric wire with an appropriate connector. If not, it can cause short-circuit fire or bodily injury from electric shock due to looseness or disconnection.</p>	 <p>Be careful about insertion</p>
<p>Danger of electric shock</p> <p>Connect grounding wire to electric source. If not, it can cause bodily injury from electric shock.</p>	 <p>Be sure to ground</p>
<p>Danger of restart</p> <p>Be sure to switch off electric source before maintenance or inspection. Single-phase motor has a thermal protector. Vacuum pump restarts become cool without warning after vacuum pump.</p>	 <p>With a thermal protector</p>
<p>CSA Requirement</p> <p>Thermally protected automatic reset. TYPE TP212. Motor restart without warning after protector trip. Min. circuit ampacity of conductor is 10A Max. branch circuit breaker is 15A</p> <p>When you use this pump in Europe.</p> <p>This vacuum pump must be equipped with a main disconnect device in accordance with requirements of EN60204-1, clause 5.3.2. It is recommended to use a circuit breaker as main breaker which is suitable for isolation according to EN60947-2 and is equipped with an operating handle which is lockable in OFF position and complies with the other requirements of EN60204-1, clause 5.3.</p>	



CAUTION

Motor burnout

Before doing any wiring, check electric source and voltage.

ISP-50-SV1 is AC100V class.

Voltage can not be changed.

Check your electric source, voltage, and wire correctly to receptacle.

Improper wiring and incorrect voltage can cause motor burnout.



Check voltage

Danger of problem recurrence and failure

If motor protective device or thermal protector activates, be sure to turn off electric source and inspect causes to solve the problem.

Do not operate until problem is solved.

Operation while problem is left unsolved can cause problem recurrence and failure.



Inspect cause of problem

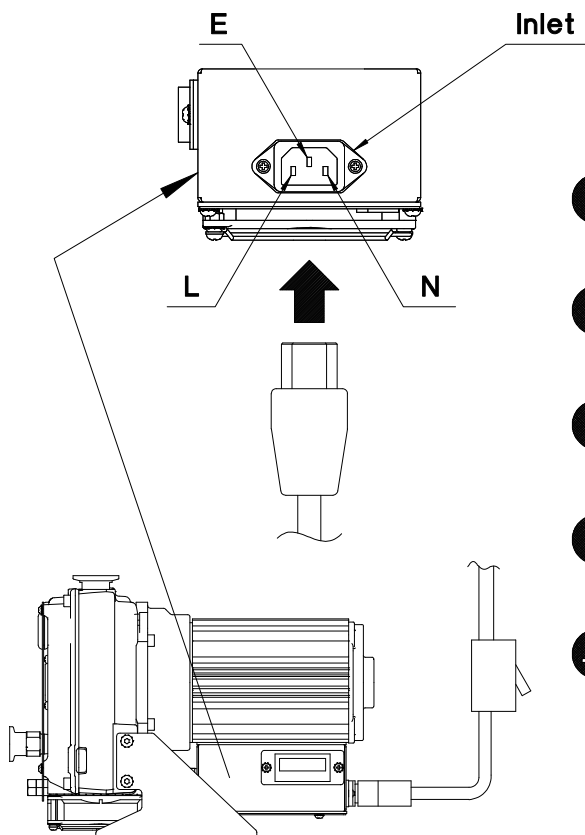

Activate the emergency stop by electric source switch or motor protective device.



Avoid motor burnout by motor protective circuit breaker (chart 1).



Use cord of larger than 2mm² (more than rated 10A) cross section area for electric source cord.



Make sure to insert the connector into the inlet.



Be sure ground the device.

Chart-1

Single-phase 100V class specifications			-		
Voltage V	Frequency Hz	Recommended protective device (or breaker) capacity A	-	-	-
100	50	2.6	-	-	-
100	60	2.4	-	-	-
115	60	2.4	-	-	-

How to wire



WARNING

Danger of fire and electric shock (refer to chart 1 on page 15)

Install motor protective circuit breaker to protect motor
 If not, it can cause bodily injury due to electric fire or electric shock.
 If you have any questions about the selection of protective devices, contact either the dealer who sold it to you or us.



Install motor protective circuit breaker to protect motor





- ① Prepare electric wire with a connector corresponding to the receptacle (table-2). Protective device must be installed between this cord and electric source.
- ② Insert a connector of electric wire into receptacle of motor power box.

Table-2

Receptacle		Electric source (primary side)
SOT-16 (Kawasaki Electric wire Co.,Ltd)	L	Single Phase AC100-115V±10%(in case of 100V class)
	N	
	⊕	Ground

※Receptacle has specified dimension to IEC60320. Selection of connector must be along with IEC60320. If you have any questions about the selection of electric wire with a connector, contact either the dealer who sold it to you or us.

3.2 Test operation

 CAUTION	
Danger of exhaust disruption Remove blank flange from inlet and outlet. Operation with blank flange being fitted can disrupt air flow or cause blank flange to fly by exhaust impetus, resulting in accident, failure, or bodily injury from contact with flying objects.	 Remove blank flange
Danger of foreign matter entering inlet When checking turning direction, be careful not to enter foreign matter into an inlet. Foreign matter entering inlet can cause failure.	 Prevent foreign matter from entering
Danger of overheating Check that cooling fan is turning and cooling air is flowing. If not, it can cause accident, failure or bodily injury such as burns due to overheating.	 Check fan

Test operation

- ① Open inlet and outlet
 Remove blank flanges (2 places) from inlet and outlet of vacuum pump.

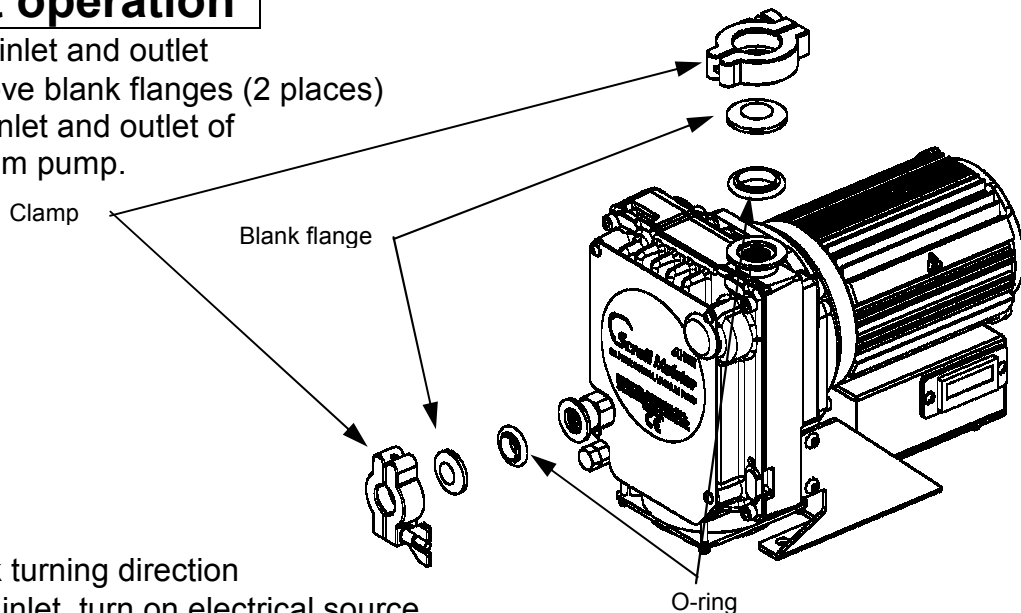

- ② Check turning direction
 Open inlet, turn on electrical source to start operating vacuum pump and check that comes out of air outlet.

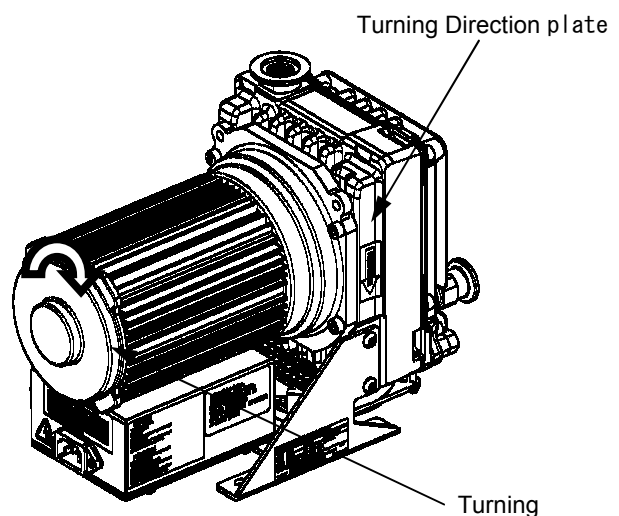

If you fit pump to vacuum system and control operation of vacuum pump by remote control, **first check pump itself for turning direction** and then fit it to vacuum system.

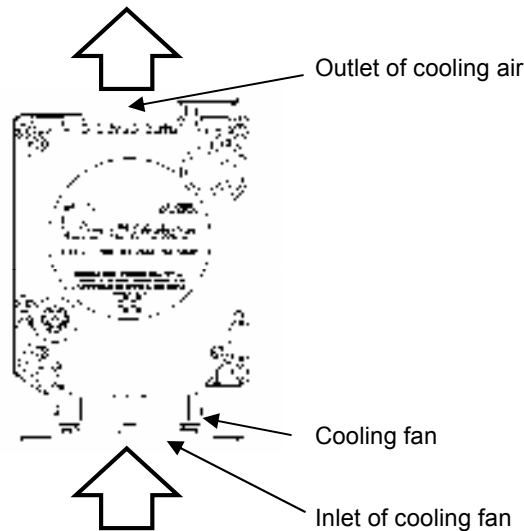

③ Check cooling air

Check that cooling fan is turning and cooling air is flowing in that direction as indicated.



3.3 Connection to vacuum system (chamber)

• Inlet of ISP-50 is NW25 and outlet is NW16.

 CAUTION	
<p>Danger of exhaust disruption</p> <p>When connecting exhaust piping to vacuum pump and when combining piping with another vacuum pump, pay attention to piping size and length so that it does not cause exhaust resistance.</p> <p>Exhaust resistance can disrupt air flow, resulting in failure and overcurrent.</p>	 <p style="font-weight: bold; margin-top: 5px;">Pay attention to exhaust resistance</p>



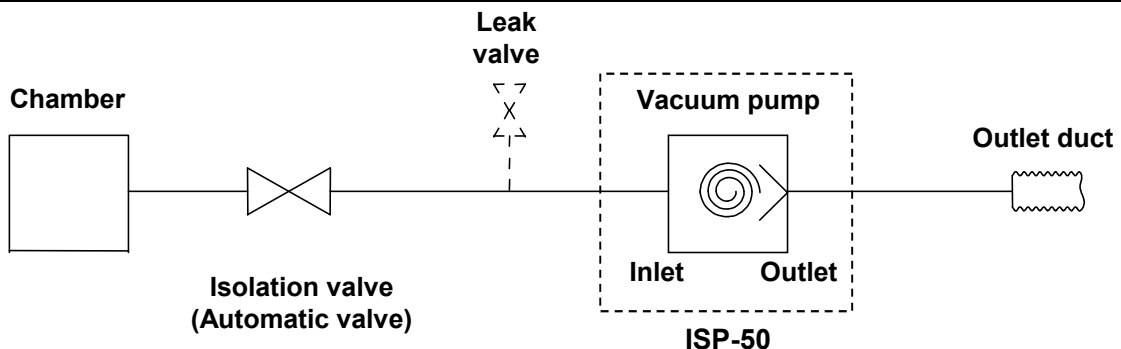



Important	
<p>Use <u>isolation valve</u> between vacuum system and inlet.</p> <p>Isolation valve is necessary to prevent the drawback of debris attached to the inside of vacuum pump into the vacuum chamber during start-up and shut-down. (We recommend the use of leak valve also). We recommend the use of an <u>automatic valve</u> as the isolation valve which closes during power failure in order to prevent the drawback of debris inside pump into the vacuum chamber during power failure.</p> <p>Use the clean connecting pipe between vacuum chamber and vacuum pump.</p> <p>We recommend the use of a flexible tube between inlet of vacuum pump and vacuum chamber so that vibration of pump does not transmit to vacuum chamber.</p> <p>When connecting exhaust piping to outlet of vacuum pump, refer to the following size and length.</p> <ul style="list-style-type: none"> • It is recommended in the case of ISP-50, max. 30m direct pipe length for exhaust pipe size NW16 (inner dia.16) <p>But if pipe length becomes longer, use a larger size exhaust pipe.</p> <p>Make sure that exhaust piping is not clogged during pump operation.</p> <p>Make sure that pressure at outlet does not exceed atmospheric pressure at any conditions.</p>	

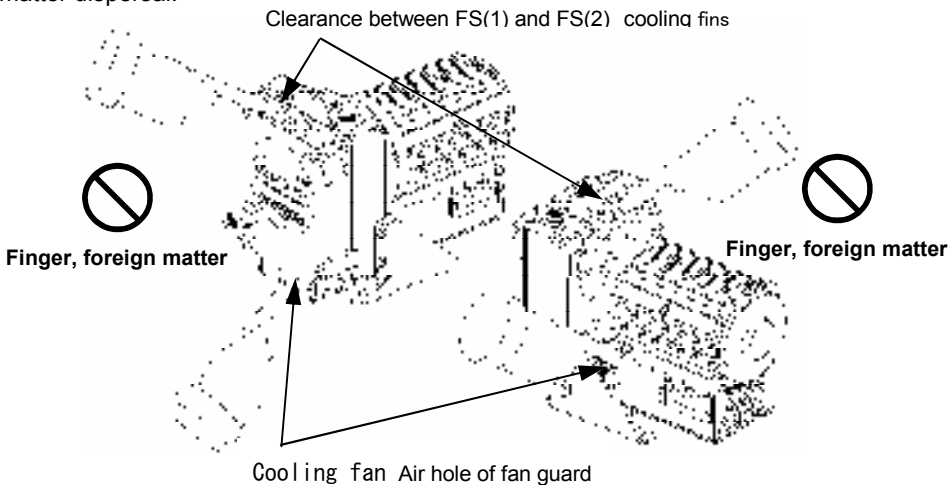

4. Operation

Be sure to use the procedure below to start up or shut down the pump.

- When you do not use air-flush device,
proceed 4.1 Standard operation [page 21].
- When you use air-flush device,
proceed 4.2 Air-flush operation [page 22].

 WARNING	
<p>Danger of explosion and ignition</p> <p>Do not evacuate gas which is hazardous to humans or explosive, flammable, or corrosive. Do not evacuate with substances containing chemicals, solvents, and powders.</p> <p>If done, it can cause failure or bodily injury by gas, explosion or ignition.</p> <div style="border: 1px solid black; padding: 5px; margin: 10px 0;"> <p style="text-align: center;"> Do not pump</p> <ul style="list-style-type: none"> · Toxic gas · Explosive gas · Flammable gas · Corrosive gas · Chemicals · Solvent · Powder <li style="margin-left: 100px;">· Water <li style="margin-left: 100px;">· Liquid </div> <p>※When evacuating vapor, operate in accordance with 4.2 [page 22].</p>	 Never evacuate hazardous gas
<p>Danger of entanglement and foreign matter dispersal</p> <p>Never put finger or foreign matter into air hole of fan cover, air hole of motor or clearance between FS(1) and FS(2) cooling fins.</p> <p>If done, it can cause bodily injury from entanglement with turning section, or foreign matter dispersal.</p> <div style="text-align: center;">  </div>	 Avoid foreign matter
<p>Danger of electric shock and entanglement</p> <p>Do not remove or alter safeguards or insulation parts.</p> <p>If done, it can cause bodily injury from electric shock or turning section and it can cause deteriorated performance and operating lifetime, and invalidate guarantee.</p>	 Never alter
<p>Danger of failure and bodily injury</p> <p>Change air-flush port only after vacuum pump is stopped.</p> <p>If you change it during vacuum pump operation, it can cause vacuum pump failure and bodily injury.</p>	 Change after vacuum pump is stopped



CAUTION

<p>Danger of exhaust disruption</p> <p>Remove blank flange from inlet and outlet. Operation with blank flange being fitted can disrupt exhaust or cause blank flange to fly by exhaust impetus, resulting in accident, failure, or bodily injury from contact with flying objects.</p>	<p>Remove blank flange</p>
<p>Danger of vacuum break and pollution</p> <p>Be sure to close isolation valve between vacuum pump and vacuum system (chamber) during start-up and stop. Start-up or stop with isolation valve in the open position can draw back gas and debris attached to inside of pump to vacuum chamber due to pressure differential, resulting in vacuum break and pollution on vacuum chamber side.</p>	<p>Start or stop after closing isolation valve</p>
<p>Danger of abnormal sound and failure</p> <p>Open inlet to atmosphere for about 5 seconds before restarting vacuum pump. If not, it can unbalance temperature inside vacuum pump, resulting in failure.</p>	<p>Open air inlet</p>
<p>Danger of exceeding permissible temperature of intake gas</p> <p>If intake gas temperature is over 50°C, be sure to install a chiller or trap between vacuum pump and vacuum chamber so that gas intake temperature of vacuum pump keeps below 50°C. If not, vacuum pump temperature can increase, resulting in failure.</p>	<p>Beware temperature of intake gas</p>
<p>Danger of remaining moisture</p> <p>When evacuating moisture, be sure to open air-flush port (air-flush operation). If you evacuate vapor while air-flush port is closed, condensed water will remain inside vacuum pump and cause failure.</p>	<p>Operate while opening air-flush port</p>
<p>Danger of insufficient vapor exhaust</p> <p>After evacuating vapor, do air-flush operation for at least one hour. If you close air-flush port or stop vacuum pump soon after evacuating vapor, condensed water will remain inside vacuum pump which will cause failure.</p>	<p>Caution after exhausting vapor</p>
<p>Danger of exceeding permissible intake gas volume</p> <p>When sending N₂ gas or dry air into air-flush port, pressure should be the same as atmospheric pressure and flow rate should be less than 4L/min. If not, it can increase pressure inside vacuum pump, resulting in failure.</p>	<p>Beware of intake gas volume</p>

Important

If it takes time to reach ultimate pressure of pump during initial operation (also operation after pump has not been used for a long time),

Close inlet, and continue operation for 6~8 hours while opening inlet for 3~5 seconds to atmosphere 2~3 times per hour. During pump stoppage, moisture might have entered inside of pump and deteriorated performance to reach ultimate pressure.

If pump has evacuated liquid such as water or high humid air (over 60%RH),

Moisture can deposit inside pump and cause pump failure. In that case, close isolation valve, and open inlet to atmosphere for 3~5 seconds several times and exhaust moisture inside pump to outside.

If pump has continued operation around ultimate pressure or continuously evacuated high humid gas

Moisture can be condensed and remains inside pump, causing insufficient ultimate pressure and failure.

In that case, do air-flush operation in accordance with 4.2 [page 22].

4.1 Standard operation

4.1.1 Start-up

- ① Check that blank flange of outlet is removed.
- ② Close isolation valve in order to prevent the drawback of debris attached to the inside of vacuum pump into vacuum chamber due to pressure differential, resulting in vacuum break and pollution.
(Open leak valve if you use leak valve).
- ③ Turn on vacuum pump.
Please install an external power switch or protective device (breaker) before letting vacuum pump operate.
- ④ Check start-up of vacuum pump and open isolation valve (close leak valve soon after start-up if you use leak valve) and evacuate vacuum chamber.

Important

When continuously operating pump at around ultimate pressure (for example, using as fore line pump of turbo molecular pump) ,

It can cause foreign matter or moisture to deposit inside pump, resulting in failure.

In that case, do air-flush operation or close isolation valve and open inlet to atmosphere for 3~5 seconds, 3~5 times daily.

Be careful not to damage air-flush port (especially air-muffler section).

If not, it can cause failure.

When doing air-flush operation,

Noise level and ultimate pressure will increase (by 7~8dB, about 5Pa).

Install pump in an area which is not exposed to debris such as iron powder, stone powder, polish powder or wood dust.

Debris can clog air-muffler, undercutting air-flush effect.

4.1.2 Shut-down

- ① Be sure to close isolation valve in order to prevent the drawback of debris attached to inside of vacuum pump into vacuum chamber during operation due to pressure differential (open leak valve if you use leak valve).
- ② Turn off vacuum pump.
Please install an external power switch or protective device (breaker) before letting vacuum pump operate.
- ③ Check shut-down of vacuum pump.

Important

Be sure to close isolation valve between vacuum pump and vacuum chamber during pump shut-down.

If vacuum pump stops during air-flush operation, atmospheric air is drawn back from air-flush port to inside of vacuum pump, and vacuum on chamber side cannot be maintained. Be sure to close isolation valve between vacuum pump and vacuum chamber to prevent the drawback of debris from vacuum pump into vacuum chamber before stopping vacuum pump.

When returning air-flush operation to standard operation, operate as per 4.2.3[page 23].

4.2 Air-flush operation

This pump is equipped with air-flush port. Before evacuating vapor, read precautions below completely and be sure to understand the contents.

Purpose of air-flush

Evacuating moisture or humid gas by vacuum pump can cause condensed water to remain in pump. This remaining water can cause failure of ultimate pressure or pump. Air-flush operation is necessary to exhaust the remaining water inside. Air-flush operation does not only exhaust moisture but also restores ultimate pressure.

※Vapor disposal volume is max. 3g/day, when doing air-flush operation(ambient temperature 25°C, humidity 60%RH).

Important

Maintenance interval of this pump is based on clean gas applications The standard differs when evacuating vapor.

You must shorten maintenance interval (5.2[page 25]) when evacuating vapor since vapor temperature, disposal volume, disposal frequency and substances in vapor have an influence on pump operation. When evacuating vapor, pay attention to all WARNING, CAUTION and Important notes (4 [page 19]).

4.2.1 Preparation

Before starting air-flush operation, first stop vacuum pump and proceed in accordance with the following procedure. Never try to do air-flush operation during operation.

Fit air-muffler

- ① Stop vacuum pump.
 - ② Remove plug from air-flush port with a spanner (nominal dia. 13mm).
 - ③ Lightly fit the attached air-muffler to air-flush port.
- ※Store the removed plug and do not misplace it.

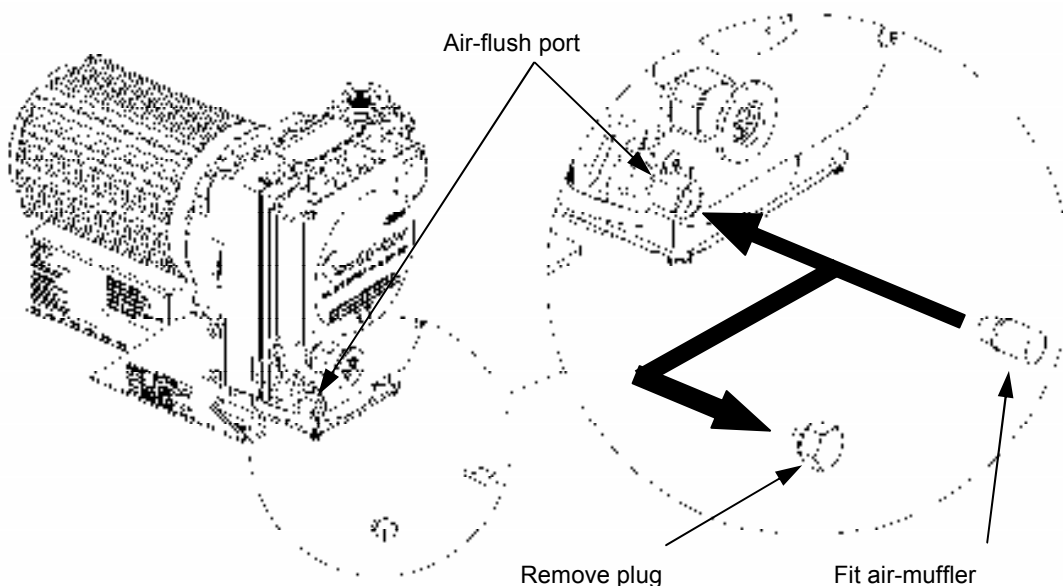

4.2.2 Start-up and shut-down

- ① Start vacuum pump according to 4.1.1 Operation [page 21].
- ② Stop vacuum pump according to 4.1.2 Shut-down[page 21].

Important

Continuous evacuating of humid gas

When evacuating vacuum chamber while humidity in chamber is high, moisture volume drawn into pump differs according to temperature and pressure in chamber.

When pumping vacuum chamber containing humid gas, be sure to open air-flush port and operate pump (air-flush operation).

Be careful not to damage air-flush port (especially air-muffler section) .

Damage to air-flush port can cause failure.

When doing air-flush operation

Noise level and ultimate pressure will increase (by 7~8dB, about 5Pa).

Install pump in an area which is not exposed to debris such as iron powder, stone powder, polish powder or wood dust.

Debris can clog air-muffler, undercutting air-flush effect.

Be sure to close isolation valve between vacuum pump and vacuum chamber during pump shut-down.

If vacuum pump stops during air-flush operation, atmospheric air is drawn back from air-flush port to inside of vacuum pump, and vacuum on chamber side cannot be maintained. Be sure to close isolation valve between vacuum pump and vacuum chamber to prevent the drawback of debris from vacuum pump into vacuum chamber before stopping vacuum pump.

When operating with air-flush OFF (closed), operate as per 4.2.3[page 23].

4.2.3 When returning to standard operation





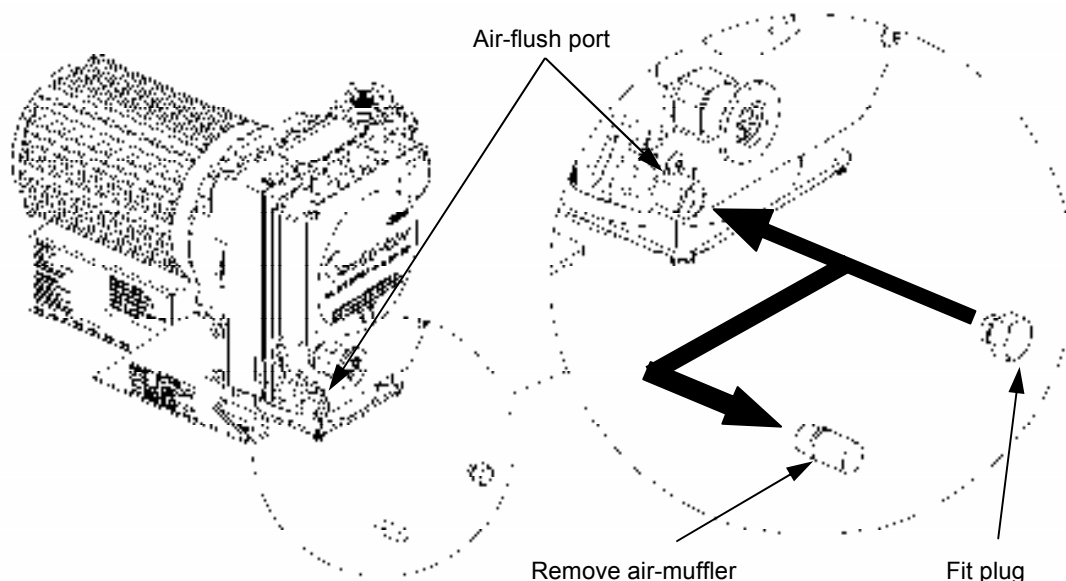

Before starting air-flush operation, first stop vacuum pump and proceed in accordance with the following procedure. Never perform this procedure during operation.

Remove air-muffler

- ① Stop vacuum pump.
 - ② Remove air-muffler from air-flush port.
 - ③ Lightly fit plug to air-flush port with a spanner (nominal dia. 13mm).
- ※When restarting air-flush operation, refer to 4.2.1~4.2.2[page 22 ~ 23] and prepare and start.
- ※Store removed air-muffler and pay attention not to misplace it.



5. Maintenance and inspection

 WARNING	
Danger of failure and bodily injury Conduct periodical maintenance and inspection. If not, it can cause insufficient performance, failure of vacuum pump, and bodily injury.	 Conduct periodical maintenance and inspection
Danger of burns Conduct maintenance and inspection only after vacuum pump becomes cool enough. Maintenance and inspection soon after vacuum pump stops can cause burn injury.	 Be careful about high temperature
Danger of restart Be sure to switch off electric source before maintenance or inspection. Single-phase motor has a thermal protector. Vacuum pump restarts become cool without warning after vacuum pump.	 With a thermal protector
Danger of electric shock Be sure to conduct maintenance and inspection after you turn off electric source. If not, it can cause bodily injury from electric shock or turning object.	 Turn off electric source
Danger of accident, failure and shorter operating lifetime Ask specialist to perform repairs. Defective repairs can cause accident, failure or shorter operating lifetime.	 Ask specialist to perform repairs

5.1 Daily maintenance and inspection

Conduct the following daily maintenance and inspection.

Items	Contents	Measures
Vacuum pump itself	Abnormal sound	Ask specialist to repair.
	Abnormal vibration	Ask specialist to repair.
	Abnormal temperature	Ask specialist to repair.
	Cooling fins are dirty or clogged	Blow air, cleaning
Cooling fan Fan cover	Abnormal rotation	Ask specialist to repair.
	Dirty, clogged, damaged	Blowing air, clean, Ask specialist to repair.
Air-muffler	Dirty, clogged	Replace
Exhaust valve	Dirty, clogged	Blowing air, clean
Electric wire	Deteriorated	Replace

5.2 Maintenance

Maintenance interval is when arrives at earlier than either 1 year or 8,000 hr. When maintenance interval has elapsed, be sure to contact our distributor who sold it to you. This vacuum pump requires maintenance conducted only by our authorized specialist.

Never try to disassemble, reassemble or alter on user's side. We are not responsible for any accidents caused by disassembly, reassembly or alteration which was done by the user or non-specialist. As the table below shows average conditions, shorten the maintenance interval and carry out maintenance if ambient and operating conditions are unfavorable or severe. The table below is based on ambient temperature 5~40°C and yearly average ambient temperature 25°C.

Maintenance interval differs from guarantee period.

The following parts are consumable and need to be replaced periodically. Whenever something goes wrong with them, replace them immediately.

Where to inspect	Maintenance interval		Every 400 times of vapor pumping
	Every 1-year or every 8,000 hours	Every 2-year or every 16,000 hours	
Bearing kit	grease / Δ	○	Δ
Tip seal set	Δ	○	Δ
Seal set	○	○	Δ
O-ring set	○	○	Δ
Exhaust valve set	○	○	Δ
Air-flush kit	○	○	○
Pin crank kit	Δ	Δ	Δ
Vacuum pump itself	Inside cleaning / Δ	Inside cleaning / Δ	Inside cleaning / Δ

○ . . . Replace
 Δ . . . Replace if something goes wrong.
 Note 1 : Maintenance interval should be shorter than either the period or operating hours.
 Note 2 : When you want further maintenance and inspection after either the 6th year or 48,000 operating hours, please contact our distributor who sold it to you.

Important

Causes of failure

Shorten maintenance interval if conditions of installation or operation are unfavorable.

In particular, ambient temperature has a great influence on failure. Maintenance interval is based on an ambient temperature 5~40°C and a yearly average ambient temperature 25°C.

Shorten the maintenance interval if temperature exceeds the foregoing. If not, it can cause failure.

Maintenance interval is not a guarantee period.

Exceeding maintenance interval

Operation exceeding maintenance interval increases risk of failure and accidents.

When maintenance interval has elapsed, be sure to contact either the distributor who sold it to you or us.

6. Problems and remedies

If something goes wrong, refer to the following chart and remedy problems.
If you cannot solve your problems, please contact either our distributor who sold it to you or us.

Problems	Causes	Remedies
Motor does not rotate.	Protective device (or breaker) activates.	※Inspect and repair.
	Electric wire is loose or cut.	Check connection. Repair or replace.
	Voltage drops.	Check size and length of cable.
	Motor malfunctions.	※Inspect and repair.
	Pump malfunctions. Foreign matter enters.	※Inspect and repair.
	Motor protection gear activates.	Air outlet is clogged. Reset thermal protector. ※Inspect and repair.
Motor stops soon.	Protective device (or breaker) activates.	※Inspect and repair.
	Voltage drops.	Check size and length of cable.
	Motor malfunctions.	※Inspect and repair.
	Pump malfunctions. Foreign matter enters.	※Inspect and repair.
	Improper exhaust piping.	Check exhaust piping diameter and length. Air outlet is clogged. Remove blank flange from exhaust outlet.
	Motor protection gear activates.	Air outlet is clogged. Reset thermal protector. ※Inspect and repair.
Ultimate pressure is insufficient.	Air leaks from piping. O-ring is damaged.	Check tightness of piping. Replace.
	Moisture and solvent are drawn.	Open inlet to atmosphere and operate for a few minutes and then close inlet and operate for about 24 hours. Do air-flush operation. Install trap and filter.
	Number of motor revolutions drops.	Check wiring and voltage. ※Inspect and repair.
	Pump malfunctions.	※Inspect and repair.
Abnormal sound, abnormal vibration	Connection becomes loose.	Tighten connection. ※Inspect and repair.
	The installation is not level.	Correct vacuum pump inclination within 5°. ※Inspect and repair.
	Foreign matter enters pump.	※Inspect and repair.
	Motor malfunctions.	※Inspect and repair.
	Pump malfunctions.	※Inspect and repair.

※ Consult your distributor.

7. Disposal

When a vacuum pump is disposed, please comply with local law such as the Waste Disposal Law.

8. Specifications

8.1 Specifications

8.1.1 ISP-50

model		ISP-50				
Displacement L/min	50Hz	50				
	60Hz	60				
Ultimate pressure Pa		≤ 20 (50Hz) ≤ 15 (60Hz)				
Leak tightness Pa · m ³ /s		$\leq 1.0 \times 10^{-7}$				
Max. inlet pressure		Atmospheric pressure				
Ambient operating temperature		5°C~40°C				
Motor	Type	Single-phase induction motor 4P Totally-enclosed , Insulation Class B IP44 Capacitor start TP212 , Automatic Reset Type				
	Output W	100				
	Voltage type	AC100V class		-		
	Voltage (note2) V	100	115	-	-	
	Rated current A	50Hz	2.3	-	-	-
		60Hz	2.1	2.1	-	-
	Revolution min ⁻¹ {rpm}	50Hz	1390	-	-	-
60Hz		1670	1700	-	-	
Noise level 1m dB(A) With air-flush ON		≤ 48 ≤ 57				
Inlet connection		NW25				
outlet connection		NW16				
Direction of inlet		Vertical				
Dimensions mm L×W×H		317×155×227				
Mass kg		12				
Cooling system		Air-cooled				
O t h e r s		With hour counter and air-flush				

Note 1 : Pumping speed and ultimate pressure remain the same during air-flush operation and standard operation.

Note 2 : Motor permissible voltage is ±10%.

Note 3 : Noise level is measured at ultimate pressure in an anechoic room.

Note 4 : Vapor handling is less than 3g/day (25°C, humidity 60%RH) during air-flush operation. Air-flush volume is 4L/min.

Note 5 : Air flush is OFF when the pump is delivered to you.

Note 6 : This product does not come with electric wire.

Please prepare a power cord with a connector corresponding to the receptacle on your side.

Note 7 : The above specifications are subject to change without notice for quality improvement.

8.2 Dimensions

8.2.1 ISP-50-SV1

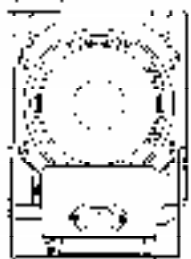
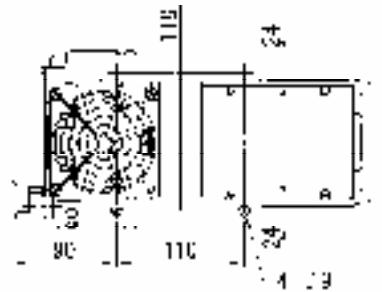
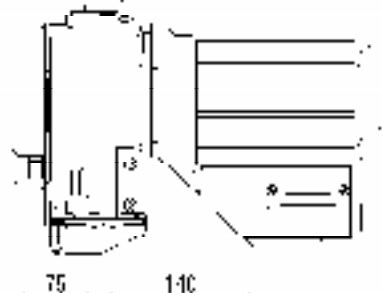
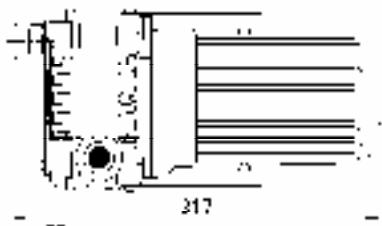

8.3 Performance data

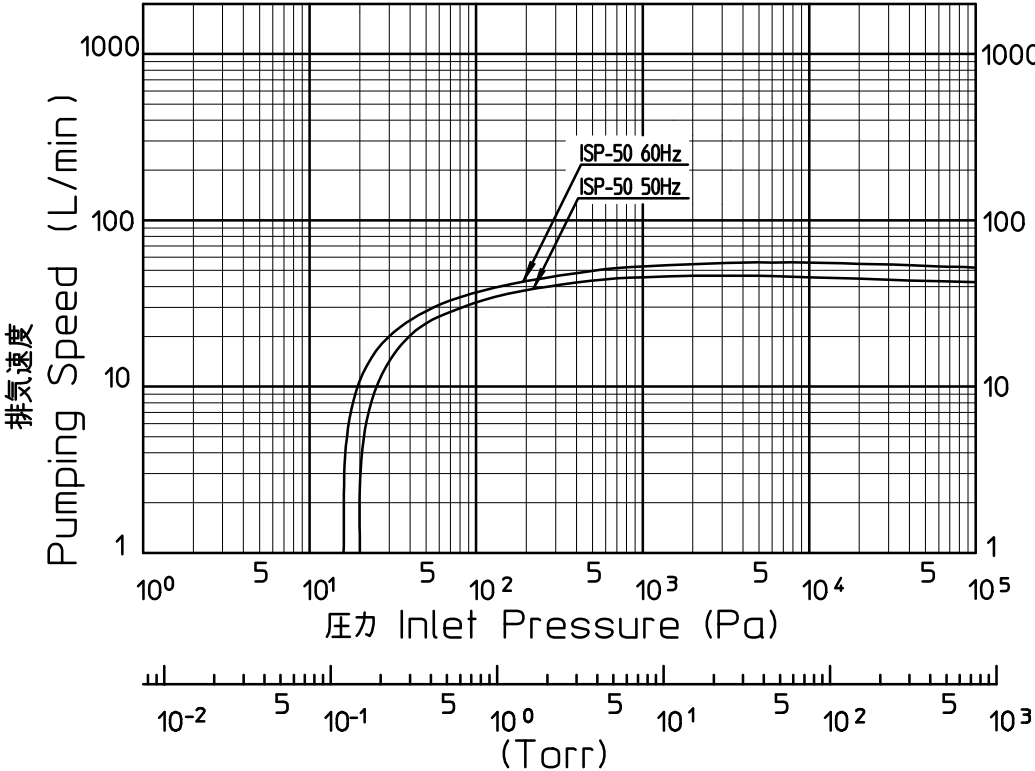

memo



ANEST IWATA Corporation

Manufacturer

3176, Shinyoshida-cho, Kohoku-Ku,
Yokohama 223-8501, Japan

Tel +81 (0) 45-591-1112

Fax +81 (0) 45-591-1539

<http://www.anest-iwata.co.jp/>

ANEST IWATA Europe S.R.L.

European agent

Corso Vigevano, 56-10155 Torino ITALY

Tel +39-1-1248-0868

Fax +39-1-185-1944

<http://www.anest-iwataeu.com/>

Manual No. V115-00

Code No.08822040