



HiCube 300 Eco, DN 100 ISO-K, MVP 015-4, 100-240



Similar Image

HiCube 300 Eco, DN 100 ISO-K, MVP 015-4, 100-240

- Compact high performance pumping station for all high and ultrahigh vacuum applications
- Plug and play solution with HiPace 300 turbopump and multistage diaphragm pump MVP 015-4
- Intermittent mode adapts the pumping station to the process conditions and saves up to 90% energy
- Easy integration of pressure gauges from the accessories

Dimensions

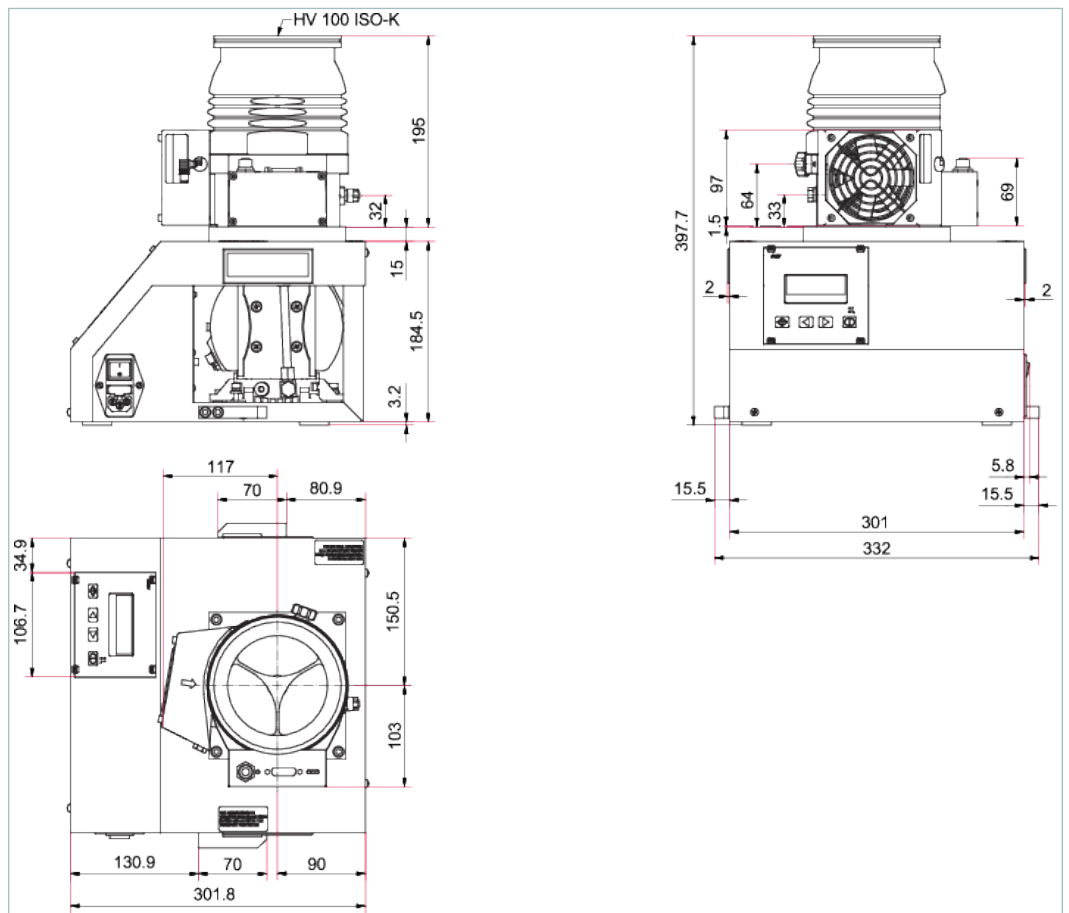

Technical Data	HiCube 300 Eco, DN 100 ISO-K, MVP 015-4, 100-240
Backing pump	MVP 015-4
Cooling method, standard	Air
Flange (in)	DN 100 ISO-K
Flange (out)	Silencer, G1/8
Mains requirement: frequency (range)	50/60 Hz
Mains requirement: voltage	100-240 V
Pumping speed backing pump at 50 Hz	0.75 m ³ /h
Pumping speed for N ₂	260 l/s
Turbopump	HiPace 300
Type	Turbo pumping station
Ultimate pressure	< 1 · 10 ⁻⁷ hPa < 7.5 · 10 ⁻⁸ Torr < 1 · 10 ⁻⁷ mbar
Weight	17.6 kg 38.8 lb

Order number

HiCube 300 Eco

PM S76 150 00

VACUUM SOLUTIONS FROM A SINGLE SOURCE

Pfeiffer Vacuum stands for innovative and custom vacuum solutions worldwide, technological perfection, competent advice and reliable service.

COMPLETE RANGE OF PRODUCTS

From a single component to complex systems:

We are the only supplier of vacuum technology that provides a complete product portfolio.

COMPETENCE IN THEORY AND PRACTICE

Benefit from our know-how and our portfolio of training opportunities!

We support you with your plant layout and provide first-class on-site service worldwide.

Are you looking for a
perfect vacuum solution?
Please contact us:

Pfeiffer Vacuum GmbH
Headquarters · Germany
T +49 6441 802-0
info@pfeiffer-vacuum.de

www.pfeiffer-vacuum.com

All data subject to change without prior notice.

PFEIFFER  **VACUUM**