



# OPERATING INSTRUCTIONS

EN

Translation of the original instructions

## DCU 002/110/180/310/400

Display and control unit

**PFEIFFER**  **VACUUM**

# Table of contents

<b>1</b>	<b>About this manual</b> .....	<b>3</b>
	1.1 Validity .....	3
	1.2 Conventions .....	3
<b>2</b>	<b>Safety</b> .....	<b>5</b>
	2.1 Safety precautions .....	5
	2.2 Proper use .....	5
	2.3 Improper use .....	6
<b>3</b>	<b>Product description</b> .....	<b>7</b>
	3.1 Product identification .....	7
	3.2 Function .....	7
	3.3 General connection description .....	8
	3.4 Range of application .....	8
<b>4</b>	<b>Connection diagram</b> .....	<b>9</b>
<b>5</b>	<b>Installation</b> .....	<b>10</b>
	5.1 Assembly .....	10
	5.2 Connecting to the mains power supply .....	10
	5.3 Connections .....	11
	5.4 Connecting a measuring device .....	12
<b>6</b>	<b>Operation</b> .....	<b>13</b>
	6.1 LC-Display .....	13
	6.2 Key functions .....	13
	6.3 Symbol description .....	14
	6.4 Switching on .....	14
	6.5 Operation .....	15
	6.6 Operation with DCU .....	15
	6.7 Pressure measurement .....	16
	6.8 Switching off .....	16
<b>7</b>	<b>Malfunctions</b> .....	<b>17</b>
	7.1 Operation display via LED .....	17
	7.2 Error codes .....	17
<b>8</b>	<b>Service</b> .....	<b>18</b>
<b>9</b>	<b>Accessories</b> .....	<b>18</b>
<b>10</b>	<b>Technical data and dimensions</b> .....	<b>19</b>
	10 Technical data and dimensions .....	19
	10.2 Dimensions .....	20
	<b>Declaration of conformity</b> .....	<b>21</b>

# 1 About this manual

## 1.1 Validity

This operating manual is for customers of Pfeiffer Vacuum. It describes the functioning of the designated product and provides the most important information for safe use of the unit. The description follows applicable EU guidelines. All information provided in this operating manual refers to the current state of the product's development. The documentation remains valid as long as the customer does not make any changes to the product.

Up-to-date operating instructions can also be downloaded from [www.pfeiffer-vacuum.com](http://www.pfeiffer-vacuum.com).

## 1.2 Conventions

### Safety instructions

The safety instructions in Pfeiffer Vacuum operating instructions are the result of risk evaluations and hazard analyses and are oriented on international certification standards as specified by UL, CSA, ANSI Z-535, SEMI S1, ISO 3864 and DIN 4844. In this document, the following hazard levels and information are considered:

<b>DANGER</b>
<p><b>Imminent danger</b> Indicates an imminent hazardous situation that will result in death or serious injury.</p>
<b>WARNING</b>
<p><b>Possibly imminent danger</b> Indicates an imminent hazardous situation that can result in death or serious injury.</p>
<b>CAUTION</b>
<p><b>Possibly imminent danger</b> Indicates an imminent hazardous situation that can result in minor or moderate injury.</p>
<b>NOTICE</b>
<p><b>Command or note</b> Command to perform an action or information about properties, the disregarding of which may result in damage to the product.</p>

## Pictographs



Prohibition of an action to avoid any risk of accidents, the disregarding of which may result in serious accidents



Warning of a displayed source of danger in connection with operation of the unit or equipment



Command to perform an action or task associated with a source of danger, the disregarding of which may result in serious accidents



Important information about the product or this document

## Instructions in the text

→ Work instruction: here you have to do something.

## Abbreviations

<b>DCU:</b>	Display Control Unit
<b>TC:</b>	Electronic drive unit for turbopump
<b>TPS:</b>	Mains pack
<b>[P:000]:</b>	Parameter of the electronic drive unit with number

## 2 Safety

### 2.1 Safety precautions



#### Duty to inform

Each person involved in the installation or operation of the unit must read and observe the safety-related parts of these operating instructions.

→ The operator is obligated to make operating personnel aware of dangers originating from the unit or the entire system.



#### WARNING

#### Danger of unsafe electrical installation

Safe operation after installation is the responsibility of the operator.

- Do not independently modify or change the pump and electrical equipment.
- Make sure that the system is integrated in an emergency off safety circuit.
- Consult Pfeiffer Vacuum for special requirements.



#### WARNING

#### Danger of electric shock

In case of defect, the parts connected to the mains supply are under voltage.

→ Always keep the mains connection freely accessible so you can disconnect it at any time.

- Observe the safety and accident prevention regulations.
- Check regularly that all safety precautions are being complied with.
- Do not loosen any plug connection during operations.
- Keep leads and cables well away from hot surfaces (> 70 °C).
- Always ensure a safe connection to the protective earthing conductor (PE, protection class I).
- The unit has been accredited with protection class IP 20. Take necessary measures when installing into ambient conditions, which afford other protection classes.
- Before carrying out any work disconnect the unit and all associated installations safely from the mains.

### 2.2 Proper use



#### NOTICE

#### EC conformity

The manufacturer's declaration of conformity becomes invalid if the operator modifies the original product or installs additional components.

→ Following installation into a plant and before commissioning, the operator must check the entire system for compliance with the valid EU directives and reassess it accordingly.

- The DCU is a display and control unit and may only be used to control Pfeiffer Vacuum Turbopumps with electronic drive unit and associated peripheral devices.
- The DCU with integrated powerpack is also used to supply power to the turbopump.
- Only operate Pfeiffer Vacuum power supplies in the available specification.

## 2.3 Improper use

Improper use will cause all claims for liability and warranties to be forfeited. Improper use is defined as usage for purposes deviating from those mentioned above, especially:

- connection to pumps or units which are not suitable for this purpose according to their operating instructions
- connection to units which have exposed voltage-carrying parts
- connection to mains supplies, which do not confirm to the regulations IEC 61010 or IEC 60950
- operation of the devices in areas with ionizing radiation

## 3 Product description

### 3.1 Product identification

#### Product characteristics

The DCU is a display and control unit for Pfeiffer Vacuum Turbopumps with integrated electronic drive unit. It enables control of all essential parameters for the electronic drive unit. It is also possible to connect a pressure gauge.

Characteristics	DCU 002	DCU 110	DCU 180	DCU 310	DCU 400
Mains supply	none	integrated	integrated	integrated	integrated
Power consumption	5 VA	130 VA	210 VA	340 VA	450 VA
Suitable for HiPace	all	10, 60, 80	300	300, 400, 700, 800	300, 400, 700, 800
Electronic drive unit	TC 110 TC 120 TC 400 TM 700 TC 1200	TC 110	TC 110	TC 400 (24 V DC)	TC 120 (48 V DC) TC 400 (48 V DC) TM 700

To correctly identify the product when communicating with Pfeiffer Vacuum, always have the information from the rating plate available.

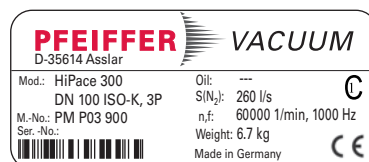

Fig. 1: Example for a rating plate

#### Scope of delivery

- Display and control unit DCU
- Interface cable M12 to M12, length 3 m
- Fixing materials
- Operating instructions

### 3.2 Function

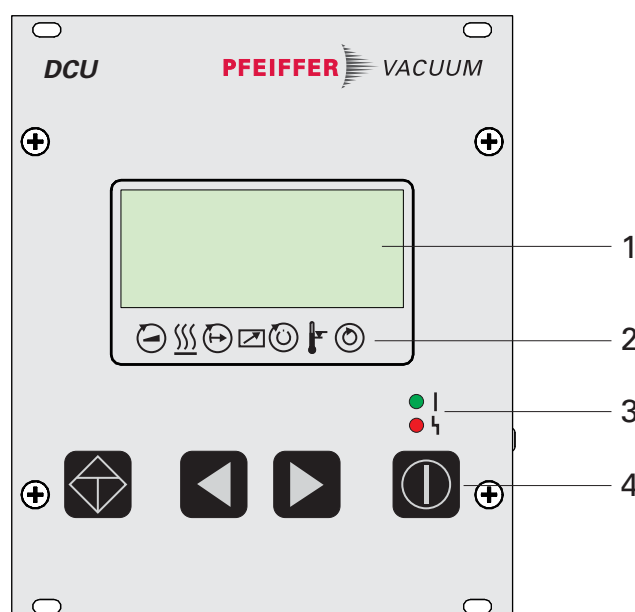
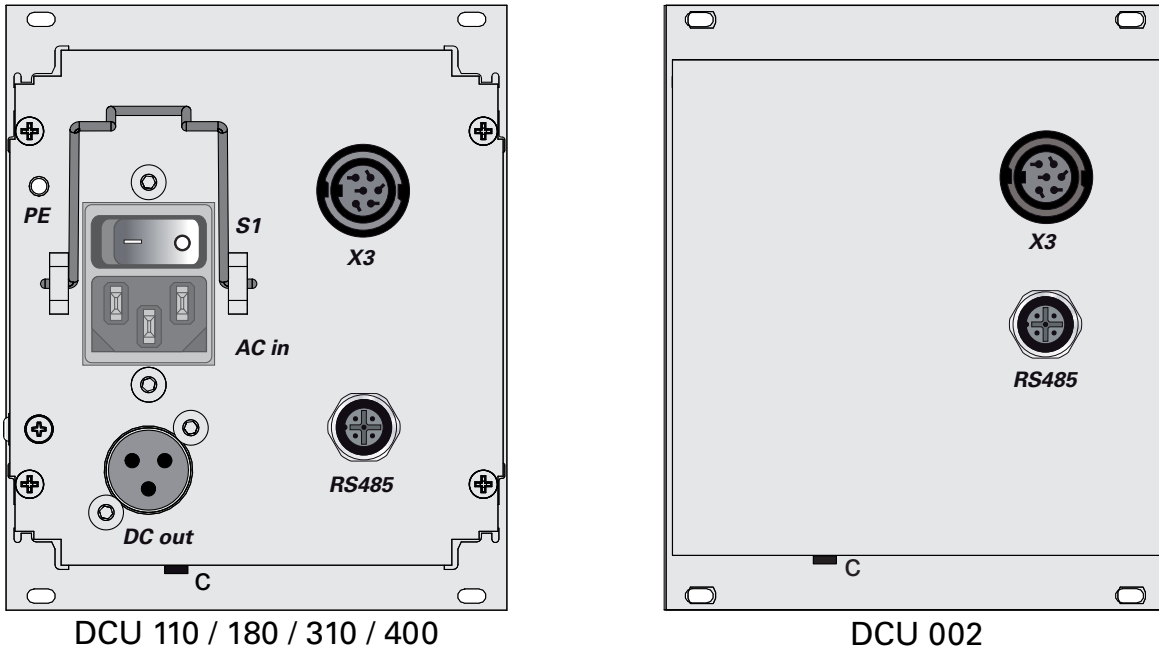

Fig. 2: Front cover DCU

- |   |                         |   |                         |
|---|-------------------------|---|-------------------------|
| 1 | LC display, illuminated | 3 | LED "Operating display" |
| 2 | Status symbols          | 4 | Operating keys          |

### 3.3 General connection description



**Fig. 3: Display and control unit DCU, rear view variants**

- |        |                          |       |                                  |
|--------|--------------------------|-------|----------------------------------|
| S1     | Mains switch             | PE    | Protective earth connection (M4) |
| AC in  | Mains connection, input  | X3    | Pressure gauge connection        |
| DC out | Mains connection, output | RS485 | Serial interface                 |
|        |                          | C     | Contrast adjustment              |

### 3.4 Range of application

Pfeiffer Vacuum display and control units DCU should be installed and operated under the following ambient conditions.

Installation location	weatherproof (internal space)
Permissible protection class	IP 20
Protection class	I
Temperature	+5 °C to +50 °C
Relative air humidity	max. 80%, at T ≤ 31°C, max. 50% at T ≤ 40°C
Air pressure:	75 kPa - 106 kPa



## 4 Connection diagram

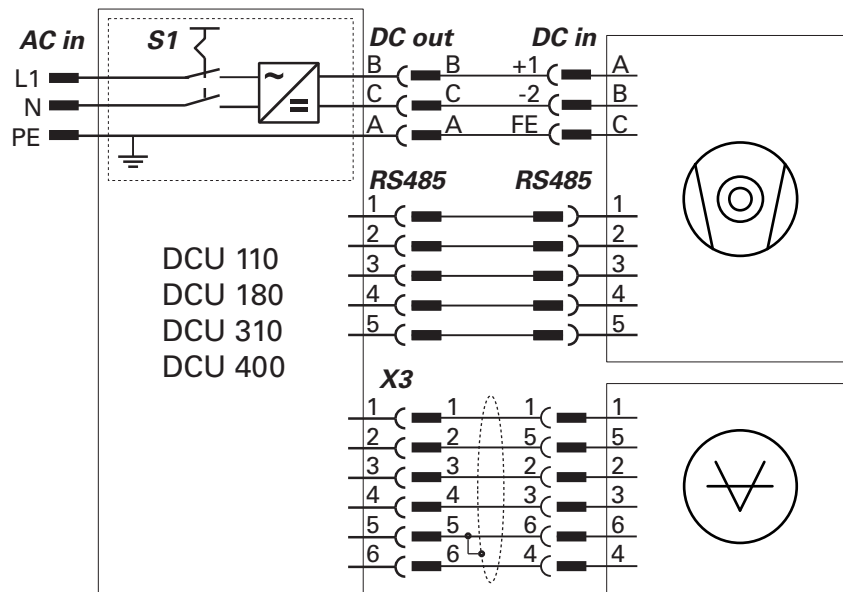

Fig. 4: Terminal diagram and layout for DCU, variants with integrated power pack

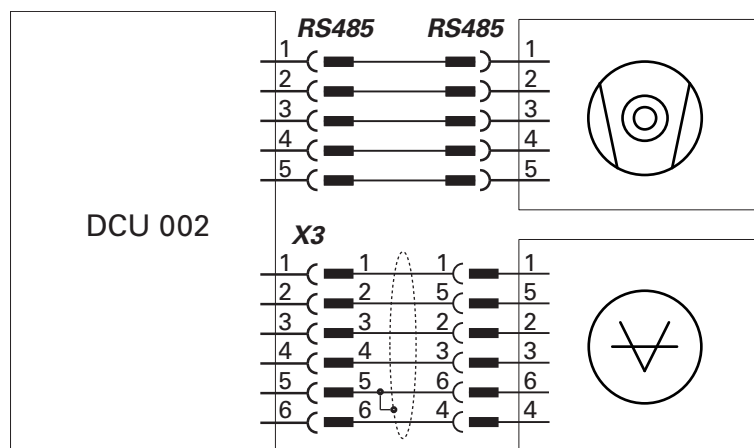



Fig. 5: Terminal diagram and layout for DCU 002

Connection to:	DCU 002	DCU 110/180/310/400
 Turbopump with electronic drive unit:	TC 110* TC 120 TC 400 TM 700 TC 1200	TC 110* TC 120 TC 400 TM 700
 Gauge type:	TP/PCR PKR 2xx APR 250/260 CMR x61 - x65	TP/PCR PKR 2xx APR 250/260 CMR x61 - x65



### Connections on electronic drive unit TC 110

Different connection possibilities (not provided in the scope of supply) are dependent on the type of electronic drive unit TC 110.

- Connection via connecting cable or adapter
- Connection for electronic drive unit "TC 110 RS" direct to the RS485 interface (power supply separately via TCP or connecting cable)
- For more information visit <http://www.pfeiffer-vacuum.com>, Keyword "HiPace accessories"

## 5 Installation

### 5.1 Assembly



#### NOTICE

##### Ensure free convection

Incorrect installation can cause damage by over-heating or create a fire hazard.

- Maintain a minimum distance of 50 mm from cooling vents to adjacent components or boundaries.
- Install the device upright.

#### Rack installation

The unit is fitted in a casing that is suitable for installation in 19"/3HE rack modules.

- Insert the unit in the guiderails of a 19"/3HE rack and screw on the front panel securely with four fixing screws provided as part of the scope of supply.

### 5.2 Connecting to the mains power supply

This only applies to DCUs with integrated power packs. The DCU 002 receives the operating voltage via the "RS485" interface for the turbopump electronic drive unit.



#### WARNING

##### Danger of unsafe electrical installation

Safe operation after installation is the responsibility of the operator.

- Do not independently modify or change the pump and electrical equipment.
- Make sure that the system is integrated in an emergency off safety circuit.
- Consult Pfeiffer Vacuum for special requirements.



#### WARNING

##### Danger of electric shock

In case of defect, the parts connected to the mains supply are under voltage.

- Always keep the mains connection freely accessible so you can disconnect it at any time.
- Order the mains cable separately (see "accessories").
- Switch off switch **S1** on the power pack (position "0").
- Plug mains cable into the mains connection "AC in".
- Lock the mains cable with the mounting bracket.
- Connect the mains cable to the mains.
- Always ensure a safe connection to the protective earthing conductor (PE, protection class I).

## 5.3 Connections

- Connect interface cable (supplied) on "RS485" to DCU and electronic drive unit.
- Make connection between "DC out" on DCU and "DC in" on electronic drive unit in accordance with the terminal diagram or with a connecting cable from the Pfeiffer Vacuum accessories.
- Connect pressure gauge if required to "X3" on the DCU.
- The RS485 serial interface is used exclusively to control the electronic drive unit on the vacuum pump. See the Operating Instructions for the respective electronic drive unit for the interface protocol specification.



### Note the operating priority of the interfaces for the electronic drive unit!

DIL switches in the connecting cable or bridges in the mating connector for the D-Sub connector for the electronic drive unit enable operation of the pump without control unit. This may cause priority conflicts with the RS485 interface.

- Disconnect the mating connector from the "remote" terminal prior to connecting a DCU to electronic drive units TC 400, TC 1200 or TM 700.
- Switch off the supreme operating control (DIL switch S1/S2 = OFF) prior to connecting a DCU to the electronic drive unit TC 110.

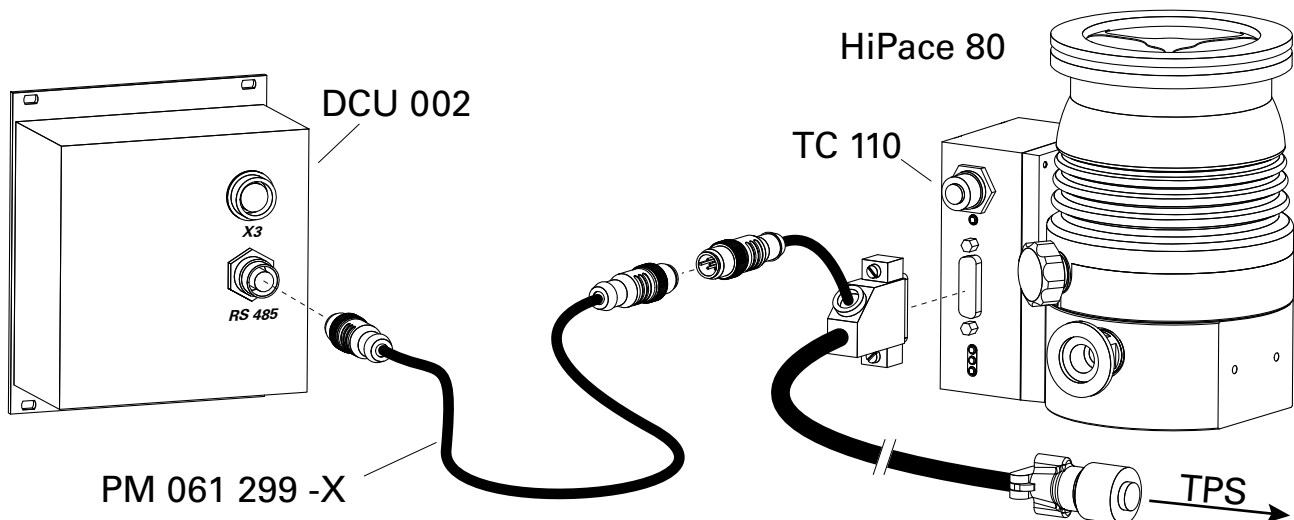

Fig. 6: Example: Connection of DCU 002 to Turbopump HiPace 80 using connecting cable

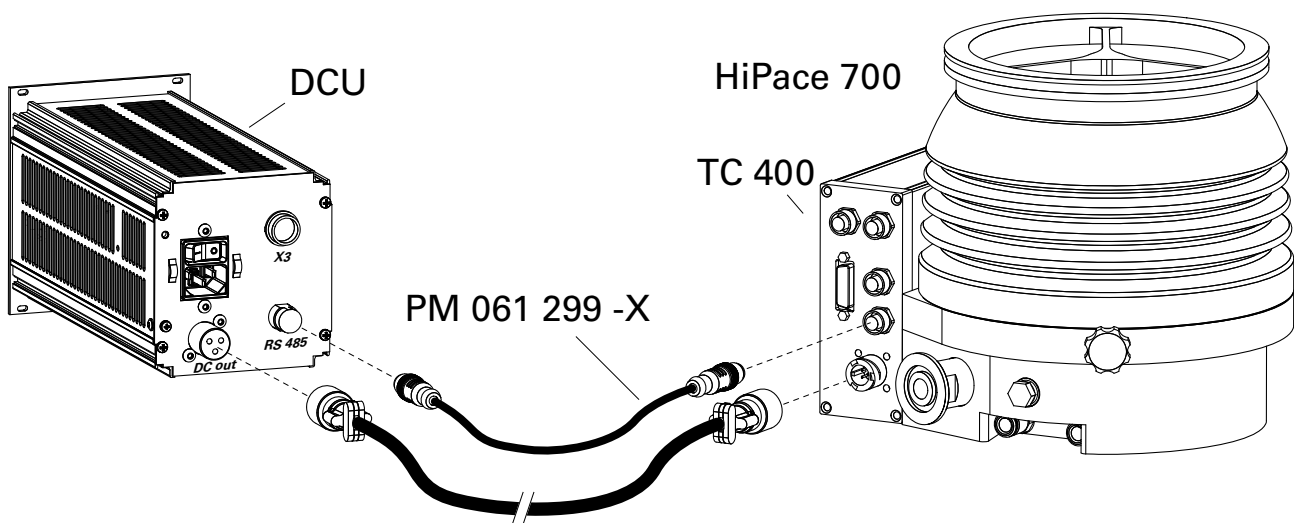

Fig. 7: Example: Connection of DCU with integrated power pack to Turbopump HiPace 700

## 5.4 Connecting a measuring device

The connector socket labelled "X3" can be used to operate a Pfeiffer Vacuum pressure measuring device from the ActiveLine series.

Gauge	Display at the DCU [P:738]
APR 250/260	CMRx61
CMR 261/361	CMRx61, by manual selection
CMR 262/362	CMRx62, by manual selection
CMR 263/363	CMRx63, by manual selection
CMR 264/364	CMRx64, by manual selection
CMR 365	CMRx65, by manual selection
MPT 200 AR	PKR2xx
PCR 280	TP/PCR
PKR 251/261/360/361	PKR2xx
PPT 200 AR	TP/PCR
RPT 200 AR	TP/PCR
TPR 270/280/281	TP/PCR

**Table 1: Valid pressure gauges for the connection to the DCU**

## 6 Operation

### 6.1 LC-Display

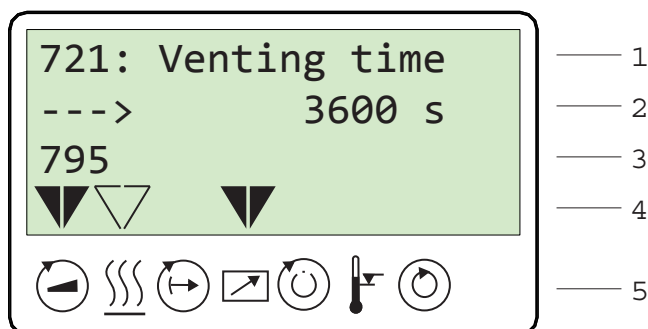

The four line LCD visualizes the functions of the DCU.

Functions are assigned as follows:

- **Line 1:** Number and name of the selected parameter (e.g. 721: Vent time).
- **Line 2:** relevant value for the selected parameter. The arrow —> indicates Edit mode.
- **Line 3** with two functions:
  - Function 1: Current messages concerning operation and control will be displayed.
  - Function 2: presentation of a required second parameter in the format [Parameter number: value]. The function for this line can be set via parameter [P:795] **Servicelin** in Line 1. All parameters can be accessed with "Servicelin". Error messages will be displayed independently of the selected function.
- **Line 4:** presentation of the current equipment status by arrows that point to the associated symbols.
- **Line 5:** Symbols (see below)

### 6.2 Key functions

4 short-travel keys (softkeys) constitute the operator interface for the DCU.



Key	Application/Example	Explanation
		<b>Reset</b> (error acknowledgement) acknowledges errors (red LED illuminates)
	[309]: ActualSpd [308]: SetRotSpd	<b>Scroll back through parameters</b> Scrolls back one parameter
	[310]: DrvCurrent [311]: OpHrsPump	<b>Scroll forwards through parameters</b> Scrolls forwards one parameter
 Simultaneous	[001]: Heating —> off	<b>Change value (Edit mode)</b> Access to displayed value, if possible (Arrow—> is displayed)
	[001]: Heating on	<b>Confirm value (Parameter selection mode)</b> Accept changed value ("change confirmed" is displayed)
	[010]: PumpgStatn on / off	<b>Pumping station ON/OFF</b> switches pumping station on or off. corresponds to parameter [010]: "PumpgStatn"

### 6.3 Symbol description

Symbol	Description	Arrow	Explanation
	Pump accelerates = [P:307]	-	NO
		▼	YES
	Preselection heating = [P:001]	-	No preselection
		▽	Preselection heating, switchpoint not attained
		▼	Heating On, switchpoint attained
	Standby = [P:002]	-	OFF
		▼	ON
	Equipment remote controlled = [P:300]	-	NO
		▼	YES
	Switchpoint reached = [P:302]	-	NO
		▼	YES
	Excess temperature	-	No excess temperatures
		▽	Excess temperature turbopump = [P:305]
		▽	Excess temperature turbo-electronics = [P:304]
		▼	Excess temperature turbopump and turbo-electronics
	Ultimate speed reached = [P:306]	-	NO
		▼	YES

### 6.4 Switching on



**Ensure correct connection in the absence of display!**

All connecting cables must always be connected to the electronic drive unit and the mains at DCU with integrated power supplies. Otherwise the correct functioning of the unit is not possible; there will be no operating display.

→ Connect all connecting cables for "RS485", "DCout" and "ACin".

→ Switch on the supply voltage with switch S1 on the DCU with integrated power pack, or when using a DCU 002 switch on via the provided power pack (e.g. TPS).

#### Self-test

The DCU carries out a self-test and a check of the connected units after switch-on. The duration of the self-test is approx. 20 s and is visualized in the display with a progress bar.

- LC display test: All characters in the LC display go dark for a short time.
- LED test: The red and green LEDs illuminate during the self-test.
- Hardware test of the DCU DCU
- Pump electronics connection test: The correct pump electronics connection and identity will be checked.
- Parameter check: Information on operating parameters will be loaded.
- Identification of the connected units: Electronic drive unit designation display.
- If no error has occurred, the DCU is ready to operate.
- The green LED flashes.

→ Reset malfunction messages using key , if necessary.

## 6.5 Operation

All function-relevant variables of a turbopump are anchored in the electronic drive unit as parameters. Each parameter has a three-digit number and a designation. Parameters can be used via Pfeiffer Vacuum display and control units or via RS-485 with the Pfeiffer Vacuum protocol.

The value of a parameter is always readable. Editable parameters are adjustment commands and target values (See the operating instructions for the respective electronic drive unit for this purpose).

### Selecting the parameters

- Preselect parameter number using the ◀ (backwards) or ▶ (forwards) keys.
  - Fast scrolling by pressing and keeping the relevant key depressed.
- The selected parameter appears in line 1, the corresponding value in line 2.

### Set parameters

- Select a parameter.
- Simultaneously press keys ◀ and ▶ .
  - The edit mode for the selected parameter is active.
  - At the beginning of the second line an arrow ( —▶ ) appears.
- Using keys ◀ , ▶ to decrease or increase the value, respective to change options.
- Simultaneously press keys ◀ and ▶ .
  - If line 3 = empty (see P:795), the following will be displayed: "change confirmed"
  - The parameter is set.
  - Edit mode for the parameter is ended. The arrow ( —▶ ) disappears.

**Edit mode( —▶ ) will disappear again automatically under the following conditions and without accepting the value to be changed:**

- Input disruption or no key operation for more than 10s.
- If an error occurs.
- Key "Pumping station ON/OFF" has been pressed.
- If line 3 = empty , "data not changed" will be displayed.

## 6.6 Operation with DCU



**Parameter set and Pfeiffer Vacuum display and control unit**  
 Pfeiffer Vacuum display and control units DCU show the basic parameter set by default. Furthermore the DCU contains parameters, which are not positioned in the electronic drive unit.  
 → Parameter [P:794] = 1 (Display of all available parameters).

#	Display	Designation	Functions	Data type	Access	Unit	min	max	default	
340	Pressure	Pressure value (ActiveLine)		7	R	hPa	1E-10	1E3		
350	Ctr Name	Type of display and control unit		4	R					
351	Ctr Software	Software of display and control unit		4	R					
738	Gaugetype	Type of pressure gauge		4	RW					
794	Param set	Parameterset	0 = basic parameter set 1 = extended parameter set	7	RW		0	1	0	
795	ServiceLin	Insert service line		7	RW				795	

The display of further parameters depends on the type of electronic drive unit.



**Start pump by pressing "Pumping station ON/OFF" key**

The "Pumping station" key only controls the parameter [P:010]. All components connected via the electronic drive unit will be activated or deactivated according to their configuration.

→ Ensure that the parameter [P:023] is also switched on for powering-up the turbopump.

## 6.7 Pressure measurement

Connection and use of a high vacuum gauge enables pressure measurement in the vacuum system via the DCU.



**Pressure measurement with the DCU**

An exact pressure measurement is not possible with the DCU. This is particularly true with linear gauges in the lower pressure range.

→ Use suitable measuring instrument.

### Displaying the gauge type

→ Parameter [P:794] = 1 (display extended parameter set)

→ Select or enter parameter [P:738] **Gaugetype**.

Gauges with identical surge impedance are only recognized as a group (e.g. CMR?). Manual input of the exact gauge type is also possible via the parameter [P:738].

Display example	Meaning
TPR 2xx	Gauge TPR 280 connected
CMR ?	Gauge of the CMR Group connected, exact type not yet set
noGaug	No pressure gauge connected

### Displaying the active pressure value

→ Parameter [P:794] = 1 (display extended parameter set)

→ Select parameter [P:340] **Pressure**.

Display example	Meaning
_____ mbar	No pressure gauge connected
< 5E-4mbar	Measuring range not reached (dependent on the device)
> 1E3mbar	Measuring range exceeded (dependent on the device)
6.3E-9mbar	Valid pressure measurement
id fam mbar	Gauge type not yet identified; see [P:340]
Error	Error in pressure gauge

## 6.8 Switching off



→ Switch off the pumping station via the "ON/OFF" button on the DCU.

→ Cut of supply voltage with switch S1 on the DCU with integrated power pack, or when using a DCU 002 via the supplied power pack (e.g. TPS).



## 7 Malfunctions









### Ensure correct connection in the absence of display!

All connecting cables must always be connected to the electronic drive unit and the mains at DCU with integrated power supplies. Otherwise the correct functioning of the unit is not possible; there will be no operating display.

→ Connect all connecting cables for "RS485", "DCout" and "ACin".

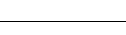
### 7.1 Operation display via LED

The red LED (error status) and green LED (operating status) on the front panel of the DCU show the following states:

LED	Symbol	LED status	Display	Meaning
Green 		Off	—	currentless
		On, flashing		"Pumping Station OFF", rotation speed $\leq 60 \text{ min}^{-1}$
		On, invers flashing		"Pumping Station ON", set rotation speed not attained
		On, constantly		"Pumping Station ON", set rotation speed attained
		On, blinking		"Pumping Station OFF", rotation speed $> 60 \text{ min}^{-1}$
Red 	L	Off	—	no malfunction, no warning
		On, flashing		Warning
		On, constantly		Malfunction

### 7.2 Error codes

Errors (\*\* Error — \*\*) always cause the connected peripheral devices to be switched off.

→ Eliminate error and reset by pressing key  .

Warnings (\* Warning — \*) are only displayed and do not cause components to be switched off.

Display DCU	Problem	Possible causes	Remedy
* Warning F110 *	Pressure measuring device	<ul style="list-style-type: none"> <li>– Gauge faulty</li> <li>– Connection to gauge detached during operation</li> </ul>	<ul style="list-style-type: none"> <li>⇒ Restart with gauge connected</li> <li>⇒ Change pressure gauge</li> <li>⇒ Install pressure gauge correctly</li> </ul>
** Error E040 **	Hardware error	<ul style="list-style-type: none"> <li>– external RAM faulty</li> </ul>	<ul style="list-style-type: none"> <li>⇒ Contact Pfeiffer Vacuum Service.</li> </ul>
** Error E042 **	Hardware error	<ul style="list-style-type: none"> <li>– EPROM check total</li> </ul>	<ul style="list-style-type: none"> <li>⇒ Contact Pfeiffer Vacuum Service.</li> </ul>
** Error E043 **	Hardware error	<ul style="list-style-type: none"> <li>– E<sup>2</sup>PROM write error</li> </ul>	<ul style="list-style-type: none"> <li>⇒ Contact Pfeiffer Vacuum Service.</li> </ul>
** Error E090 **	Internal device error	<ul style="list-style-type: none"> <li>– RAM not large enough</li> <li>– DCU is connected to incorrect pump electronics</li> </ul>	<ul style="list-style-type: none"> <li>⇒ Contact Pfeiffer Vacuum Service.</li> <li>⇒ Connect correct pump electronics</li> </ul>
** Error E698 **	Communication error	<ul style="list-style-type: none"> <li>– The electronic drive unit does not respond</li> </ul>	<ul style="list-style-type: none"> <li>⇒ Contact Pfeiffer Vacuum Service.</li> </ul>

Further error and warning messages are described in the Operating Instructions for the electronic drive unit.

## 8 Service

### **Pfeiffer Vacuum offers first-class service!**

- Fast replacement with exchange products in mint condition
- Advice on the most cost-efficient and quickest solution

Detailed information, addresses and forms at: [www.pfeiffer-vacuum.com](http://www.pfeiffer-vacuum.com) (Service).

### **Service orders**

All service orders are carried out exclusively according to our repair conditions for vacuum units and components.

## 9 Accessories

An overview about original Pfeiffer Vacuum accessories for the designated device can be found in the operating instructions of the respective vacuum pump.

## 10 Technical data and dimensions

### 10.1 Technical data

Parameter	DCU 002	
Connection	12-30 V DC	
Ambient temperature	5-50 °C	
Protection category	IP 20	
Power consumption	5 VA	
Weight	0.4 kg	

  

Parameter	DCU 110	DCU 180
Ambient temperature	5-50 °C	5-50 °C
Protection category	IP 20	IP 20
Mains requirement: frequency (range)	50/60 Hz	50/60 Hz
Mains requirement: power consumption	130 VA	210 VA
Mains requirement: voltage (range)	115-230 (-20-+15 %) V AC	115-230 (-20-+15 %) V AC
Output voltage	24 (± 2 %) V DC	24 (± 2 %) V DC
Output current	4.6 A	7.5 A
Weight	1.2 kg	1.7 kg

Parameter	DCU 310	DCU 400
Ambient temperature	5-50 °C	5-50 °C
Protection category	IP 20	IP 20
Mains requirement: frequency (range)	50/60 Hz	50/60 Hz
Mains requirement: power consumption	340 VA	450 VA
Mains requirement: voltage (range)	115-230 (-20-+15 %) V AC	115-230 (-20-+15 %) V AC
Output voltage	24 (± 2 %) V DC	48 (± 2 %) V DC
Output current	12.5 A	8.4 A
Weight	1.85 kg	2.3 kg

## 10.2 Dimensions

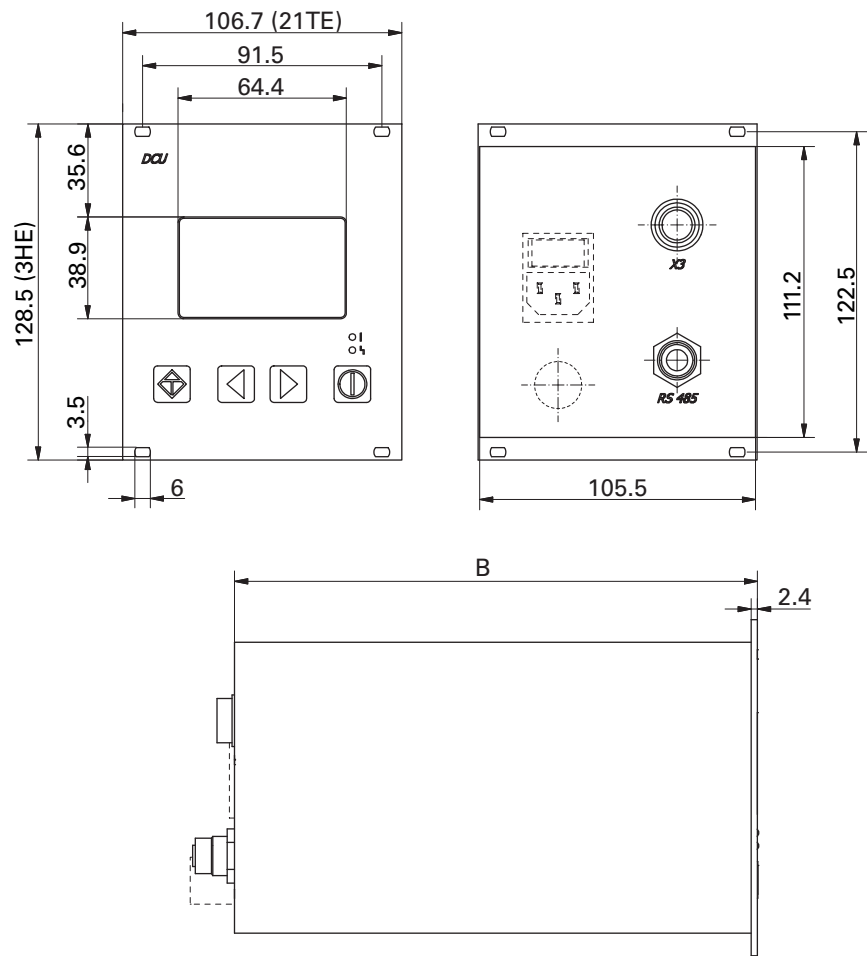

Dimension	DCU 002	DCU 110	DCU 180	DCU 310	DCU 400
B	52.5 mm	200.0 mm	230.0 mm	230.0 mm	230.0 mm



# Declaration of conformity

We hereby declare that the product cited below satisfies all relevant provisions according to the following **EC directives**:

- **Electromagnetic Compatibility 2014/30/EU**
- **Low Voltage 2014/35/EU**

**DCU**

**DCU 002/110/180/310/400**

Harmonised standards and national standards and specifications which have been applied:

DIN EN 61000-3-2 : 2010  
DIN EN 61000-3-3 : 2009  
DIN EN 61010-1 : 2010  
DIN EN 61326-1 : 2013  
DIN EN 62061 : 2013  
Semi F47-0200  
Semi S2-0706

Signature:

Pfeiffer Vacuum GmbH  
Berliner Straße 43  
35614 Asslar  
Germany

---

(Dr. Ulrich von Hülsen)  
Managing Director

2016-04-18

## **VACUUM SOLUTIONS FROM A SINGLE SOURCE**

Pfeiffer Vacuum stands for innovative and custom vacuum solutions worldwide, technological perfection, competent advice and reliable service.

## **COMPLETE RANGE OF PRODUCTS**

From a single component to complex systems:

We are the only supplier of vacuum technology that provides a complete product portfolio.

## **COMPETENCE IN THEORY AND PRACTICE**

Benefit from our know-how and our portfolio of training opportunities!

We support you with your plant layout and provide first-class on-site service worldwide.

Are you looking for a  
perfect vacuum solution?  
Please contact us:

**Pfeiffer Vacuum GmbH**  
Headquarters • Germany  
T +49 6441 802-0  
info@pfeiffer-vacuum.de

[www.pfeiffer-vacuum.com](http://www.pfeiffer-vacuum.com)

**PFEIFFER**  **VACUUM**