

---

# DRYTEL 1025 pumping unit

## Welcome

You have just purchased a DRYTEL 1025 pumping unit.

We would like to thank you and are proud to count you among our customers.

This product has benefited from Alcatel's many years of experience in pumping unit design.

**To guarantee high performances and full satisfaction from this equipment, we suggest that you study this manual before any intervention on your pumping unit, particularly the chapter on installation and start-up.**

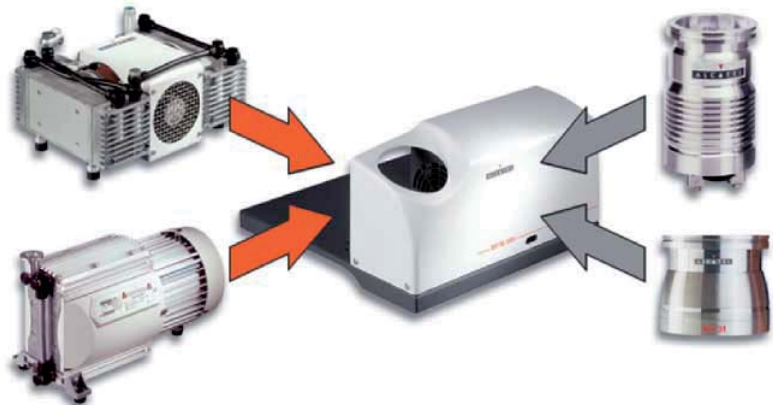

## Applications

Drytel 1025 pumping units are recommended for all applications in which a clean and dry vacuum is required.

They may be used for different types of application:

- INDUSTRY: Cryogenics, freeze-drying etc.
- INSTRUMENTATION: Mass spectrometry, Airlock analysis etc.
- RESEARCH AND DEVELOPMENT: Pumping small volumes, Gauge calibration, etc.
- VARIOUS SEMICONDUCTOR PROCESSES: Airlock pumping, etc.

## Advantages

- Clean pumping,
- Flexibility, reliability and strength,
- Compact size and low weight,
- Easy maintenance,
- Economical solution.

---

## **DRYTEL 1025 pumping unit**

**This product complies with the requirements of European Directives, listed in the Declaration of Conformity contained in G 100 of this Manual. These Directives are amended by Directive 93/68/E.E.C (E.C Marking).**

**Copyright/Intellectual property:**

**The use of Adixen products are subject to copyright and intellectual property rights in force in any jurisdiction.**

**All rights reserved, including copying this document in whole or any part without prior written authorization from Alcatel Vacuum Technology France.**

**Specifications and information are subject to change without notice by Alcatel Vacuum Technology France.**

# Contents

## User's manual DRYTEL 1025

<b>Chapter A</b>	<b>PRESENTATION</b>
A 10 - Presentation A 20 - Description A 40 - Technical characteristics A 50 - Options A 60 - Accessories	
<b>Chapter B</b>	<b>START-UP</b>
B 10 - Safety instructions B 20 - Unpacking, storage B 30 - Mechanical connection B 40 - Electrical connection B 50 - Connecting the remote control connector (option)	
<b>Chapter C</b>	<b>OPERATION</b>
C 10 - Safety instructions C 20 - Using the pumping unit in local mode C 30 - Using the pumping unit in remote control mode (option) C 40 - Using automatic air ballast (option)	
<b>Chapter D</b>	<b>MAINTENANCE</b>
D 10 - Maintenance safety instructions D 30 - Troubleshooting and remedies D 40 - Maintenance frequencies	
<b>Chapter E</b>	<b>MAINTENANCE SHEETS</b>
E 20 - Pumping unit dispatch procedure E 30 - Electrical configuration selection E 40 - Pumping unit maintenance E 50 - AMD1 diaphragm pump maintenance E 51 - AMD4 and AMD4C Primary pump maintenance E 60 - MDP 5011 pump lubrication E 70 - Starting up the MDP 5011 pump after refilling the bearings with grease	
<b>Chapter F</b>	<b>MAINTENANCE COMPONENTS</b>
F 000 - Spare parts - Instructions of use F 10 - Maintenance kit	
<b>Chapter G</b>	<b>APPENDIX</b>
G 100 - Declaration of conformity G 200 - Safety questionnaire	

## User's manual DRYTEL 1025

### CAUTION

Indicates a potentially hazardous situation which, if not avoided, could result in property damage.

### ⚠ CAUTION

Indicates a potentially hazardous situation which, if not avoided, could result in moderate or minor injury. It may also be used to alert against unsafe practices.

### ⚠ WARNING

Indicates a potentially hazardous situation which, if not avoided, could result in death or severe injury.

### ⚠ DANGER

Indicates an imminently hazardous situation that, if not avoided, will result in death or severe injury (extreme situations).

## Presentation

### Drytel 1025 pumping units



### Using and principle of pumping units

Drytel 1025 pumping units are a combination of vacuum pumps:

- an hybrid or simple turbomolecular secondary pump.
- an a multi-stage diaphragm pump.

They allow to reduce the pressur of the vessel from atmospheric pressure until low vaccum.

The inlet gases are compressed and rejected at atmospheric pressure.

Drytel 1025 pumping units are designed for the pumping gases or vapors and must not be use for the liquid pumping.

Howener vapors emanated from liquids or solids can be pumped when diluting them with inert gases.

- They are not designed for working as compressor.
- They are not designed for pumping gases at inlet pressure higher than atmospheric pressure.

## Presentation

### Main characteristics

- No contamination by internal lubricants.
- High performance.
- Economical solution.

### Different products available

	<b>DRYTEL 1025</b>
Primary pump	AMD1 or AMD4
Secondary pump	MDP 5011 or ATH 31 +
Options	Automatic air ballast
	Remote control
	DN16 exhaust end fitting

## Description

**Description** The Drytel 1025 pumping unit is a dry (oil-free) pumping system, capable of pumping from atmospheric pressure up to secondary vacuum pressures.

	DRYTEL 1025
Primary pump	AMD1 or ADM4
Secondary pump	MDP 5011 or ATH 31 +

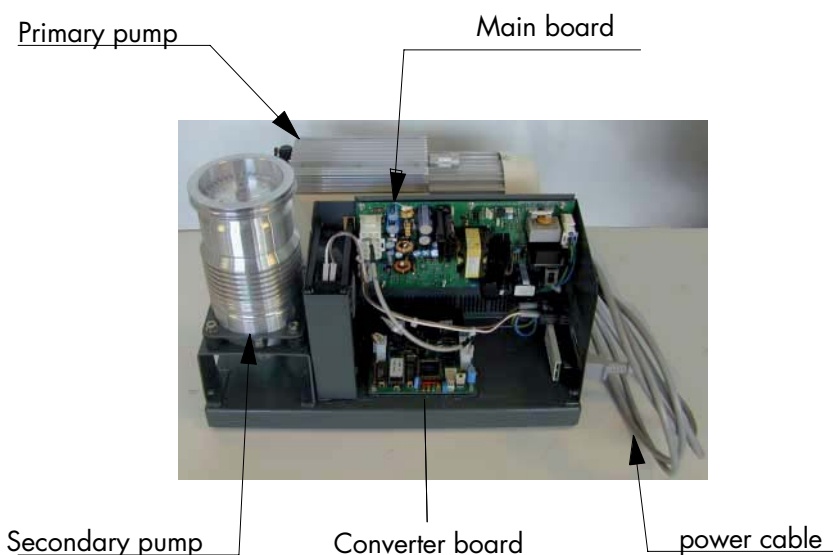

**Principle diagram** At the secondary pump exhaust, the gases are evacuated to the atmosphere by a primary pump.

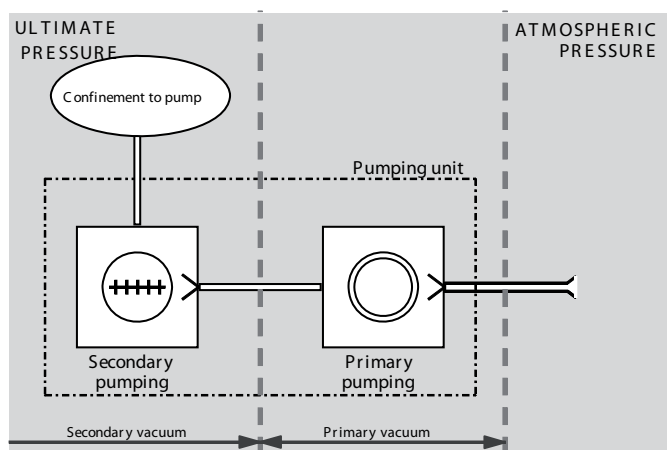

## Description

### Control electronics

- Front panel**
- The secondary pump status indicator. The operating status of the pumping unit is represented by the three indicator lights: Red, Yellow and Green.

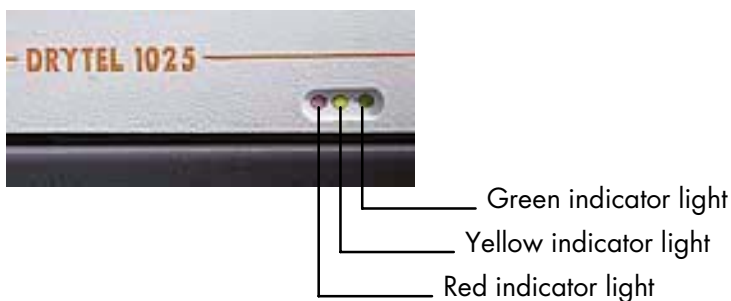

Green: the secondary pump has reached its synchronism speed.  
 Yellow: the secondary pump is speeding up.  
 Red: fault on the pumping unit.  
 See sheet **C 20**. Using the pumping unit in local mode

### Side panel

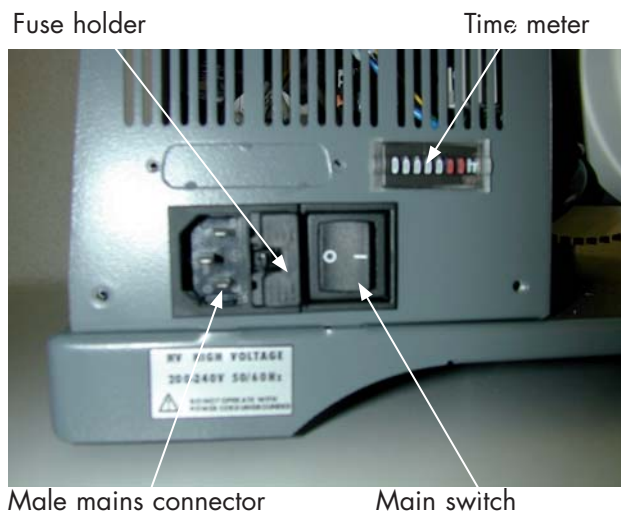

Optional remote control connector.  
 See sheets **A 50** **B 50** **C 30**



## Description

### Automatic air ballast operating principle

When condensable gases are pumped, depending on the nature of the pumped gases, pressure and temperature conditions, they may condense in the dead volumes of the primary pump.

When the pumping unit is at low pressure, the primary pump is at the limit vacuum. The gases no longer pass through, its check valves no longer open and the condensates remain inside.

These condensates mix with dust and create a destructive abrasive for the pump diaphragm.

The introduction of gas at the last stage of the pump has various effects:

- the dilution of the pumped gas and the reduction of the partial vapor pressure of the residual gas in the pump.
- it increases the compression of the pump and heats it, reducing the risk of condensation by increasing of the temperature of the internal pump.
- it reduces in the last stage the partial pressure of the pumped gas and it stops its condensation when the gas reaches the atmospheric pressure.
- in case of pumping at low pressure, when there is no flow, it gives the possibility to open the valves and evacuate the residual gases.

### Principle diagram

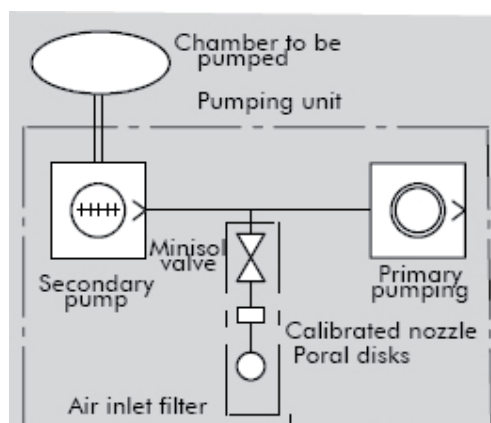

Powering up the solenoid valve opens it and introduces a calibrated quantity of air via a nozzle parallel to the pumped gas.

The sintered metal PORAL disks protect the nozzle from dust or foreign bodies carried by the gas or from the atmosphere.

The air inlet filter protects against dust or foreign bodies from the atmosphere.

In case of accident or if the pump stops, a valve closes this inlet and keeps the pump anti-suck back.

For more efficiency, it is possible to use a dry neutral gas as a purge gas.

See sheet  **B 30** Connecting the automatic air ballast (option)

See sheet  **C 40** Using the automatic air ballast (option)

## Technical characteristics

### Technical data

Secondary pump		MDP 5011				ATH 31 +			
Primary pump		AMD1		AMD4		AMD1		AMD4	
Ultimate pressure (*)	mbar	< 1.10 <sup>-6</sup>				< 1.10 <sup>-8</sup>			
Pumping rate N <sub>2</sub> (*)	l/s	7.5				30			
Pumping rate He		4				20			
Pumping rate H <sub>2</sub>		3				14			
Primary pump pumping rate (50 and 60 Hz)	m <sup>3</sup> /h	1.0 / 1.2		3.3 / 4.0		1.0 / 1.2		3.2 / 4.0	
Exhaust pressure	mbar	Atmosphere							
Start-up time	min	< 2							
Cooling system	/	Air							
Maximum inlet pressure	mbar	5				0.5			
Maximum exhaust pressure	Bar	1.1							
AMD1, AMD4 diaphragm pumps tightness	mbar.l/s	5.10 <sup>-4</sup>							
Weight	Kg	15				26			
Storage temperature	°C	- 10 to + 60							
Inlet flange	/	DN 63 ISO K				DN 63 ISO K - DN 63 CF F			
Exhaust flange	/	Noise filter							
		DN 16 exhaust end fitting							
Frequencies	HZ	50 / 60							
Mains voltage	V	100 / 115 200 / 230 / 240							
Power consumption at start-up	W	210	180 (50Hz)	370 (60Hz)	320 (50Hz)	220 (60Hz)	205 (50Hz)	380 (60Hz)	335 (50Hz)
Power consumption at synchronism	W	160	130 (50Hz)	310 (60Hz)	250 (50Hz)	160 (60Hz)	135 (50Hz)	310 (60Hz)	270 (50Hz)
Noise level	dBA	< 52		< 56		< 52		< 56	

(\*) Ultimate vacuum measured according to PNEUROP specification

## Technical characteristics

Secondary pump		MDP 5011		ATH 31 +	
Primary pump		AMD1	AMD4	AMD1	AMD4
Automatic air ballast					
- Neutral gas pressure	bar			1 to 1.10	
- Flow rate	sccm			60	
- Solenoid valve power	V DC			24	
supply voltage					
- Connection thread				1/8G	
Maximum weight of inlet flange	Kg			30	
Maximum temperature pumping gases	°C			60	
Maximum operating temperature	°C			35	

## Technical characteristics

### Gas and various configurations of pumping

Pumped gas	Point to examine when pumping	Precautions to take	Type of Drytel Accessories to take					Remark
			Drytel 1025	Drytel 1025 C	Gas ballast	Smoke aspiration	Purge	
Dry air	Nothing	Nothing	x	x				
Moist air	Avoid condensation which reduce the pumps performance and reliability.	Avoid over pressure at exhaust.	x	x	x	x		
No corrosive condensable gas	Check that the saturing vapor pressure of gas is not reached when pumping.	Use a gas ballast Avoid over pressure at exhaust.	x	x	x			Gas ballast of Drytel or l'AMD.
Gas slightly corrosive	Avoid moisture which could created phase condensable corrosive and then destroy the pump components.	Dilute the gas to reduce the concentration. Avoid over pressure at exhaust Make sure that tightness of group is efficient.	x	x		x	x	Purge at inlet.
Condensable slightly corrosive gas	Avoid moisture which could created phase condensable corrosive and then destroy the pump components Check that the saturing vapor pressure of gas is not reached when pumping.	Dilute the gas to reduce the concentration. Use a gas ballast Avoid over pressure at exhaust Make sure that tightness of group is efficient.	x	x	x	x	x	Possibility of standard Drytel with purge at inlet

## Technical characteristics

Gas highly corrosive	Avoid moisture which could create phase condensable corrosive and then destroy the pump components.	Dilute the gas to reduce the concentration. Avoid the over pressure at exhaust. Check that tightness of group is efficient.		x		x	x	
Other gas highly corrosive	Avoid the leak to outside. Protect the pump.	Consult us.						Not recommended. Use an other pump chemical version.
Toxic gas	Avoid the leak to outside	Check that tightness of group is efficient.						Not recommended Use an other pump chemical version
Explosive gas	Eviter d'atteindre le point éclair du gaz lors de la compression.	Avoid any accumulation of gas inside pump line and near flame and sparks.		x	x	x	x	Not recommended or with a poor quantity and with intense dilution. It is possible with a poor concentration with intense dilution.
Other gases	In case of doubt, for these complex pumpings or at risk to operator and environment, <b>consult us.</b>							

This list is not exhaustive. During any applications, you can not know what the pumping group really pumps. The pumping line equipment degassing can produce reactive gases. The pumped gases composition can be modified and to change its composition.

## Options

### Exhaust end fitting

**AMD1**  
DN 16 exhaust end fitting

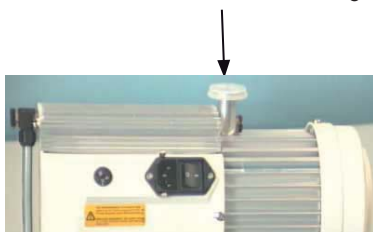

**AMD4**  
DN 16 exhaust end fitting

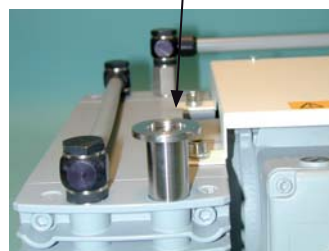

It is used to collect pumped gases to prevent them from being discharged into the atmosphere. In this case, the pump has not a silencer and must be connected to the smoke evacuation pipe.

### Remote control

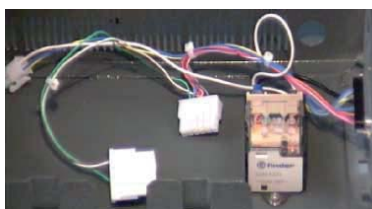

The remote control function is used for:

- Remote control of the On/Off functions:
  - of the primary pump,
  - of the secondary pump.
- Copying the status of indicator lights (

See sheet  **B 50** Connecting the remote control (option).

See sheet  **C 30** Using the pumping unit in remote control mode (option).

### Automatic air ballast

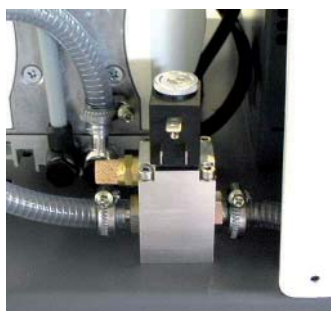

- Reduces risk of condensation in primary pump when pumping unit is pumping on condensable gases.
- Used to improve pumping of light gases by function air purge.
- In case of accident or if the pump stop, a valve closes this inlet and keeps the pump anti-suck back.

## Accessories

Different connection accessories are available in the manufacturer catalogue.

**Inlet filter** Prevents the introduction of foreign bodies into the secondary pump inlet.

	Reference		
	MDP 5011	ATH31 +	ATH31+
	DN 63 ISO-K		DN 63 CF-F
Screen filter (2.5 mm mesh)	063117	102565	102662
20 μ inlet filter	062912	102668	102664

## Vacuum connections

	Reference		
	MDP 5011	ATH31 +	ATH31+
	DN 63 ISO-K		DN 63 CF-F
Aluminium centring ring (without O-ring)	063212	102568	-
O-ring DN 63	082028		-
Rotatable flange	068420		-
Blank flange	068285		303166
Pack of 10 copper-gasket	-		303290
Flange	-		303124
Screw kit	303416		
4 clamps	303056		-

---

## Accessories

### AMD1 diaphragm pump air ballast

Reference 110949



This air ballast is settled on the primary pump and protects it from condensation during the pumping of condensable gases.

- It is a permanent device which is not piloted by remote control.
- It is used during the pumping of high vapor pressure gases.
- Its flow is 75 l/h.
- When it is used, the unit is not anti-suck back.



## Safety instructions

Before powering up, the user must study the manual and follow the safety instructions.

### Decontamination – product dismantling

According to the regulations 2002/96/CE about Waste of electrical and electronical equipments, and 2002/95/CE about Restriction of Hazardous substances, the manufacturer provides a recycling paid service for the end-of-life of waste electrical and electronic equipment. Any obligation of the manufacturer to take back such equipment shall apply only to complete not amended or modified equipment, using Alcatel original spare parts, delivered by Alcatel, containing i.e. all its components and sub-assemblies.

This obligation will not cover the shipping cost to an Alcatel take back facility.

Before returning the product, fill in the safety questionnaire, attach it to the product before shipping to the service-repair office closest to you.

### CAUTION

The pumping units must be connected to an electrical installation in compliance with decree 88 - 1056 of 14th November 1988.

### ⚠ CAUTION

The vacuum pump is also a compressor: incorrect use may be dangerous. Study the user manual and follow the safety instructions before starting the pump.

### CAUTION

Our products are designed to comply with current EEC regulations. Any modification of the product is liable to result in non-compliance with regulations, or affect the EMC (Electromagnetic compatibility) performances and safety of the product. Alcatel declines responsibility for consequences resulting from such an intervention.

### ⚠ CAUTION

Products' EMC performances are subject to the installation being carried out in compliance with the applicable EMC regulations. Particularly in environments subject to interference, it is essential to:

- use shielded links and connections for interfaces,
- stabilise the power supply line with a mesh from the power supply source up to a distance to 3 m with respect to the product input.

## Safety instructions

**⚠ CAUTION**

The performances and operating safety of this product can only be guaranteed if it is used in compliance with its normal use.

**⚠ CAUTION**

Make sure that the chambers or confinements connected to the pumping unit inlet can withstand a negative pressure of 1 bar with reference to atmospheric pressure.  
Check that the pumping unit is connected correctly to the equipment.

**⚠ CAUTION**

Do not move or induce a shock on a pump in operation. This could result in a risk of crash.

**⚠ CAUTION**

Before any maintenance operation on a product performed by a maintenance operator not qualified on safety regulations (EMC, electrical safety, chemical pollution, etc.), shut off the product from its different power sources (electricity, compressed air, etc.).

**⚠ WARNING**

It is dangerous to access the rotor of a turbomolecular pump on which the intake is not connected.  
Even if the pump is not powered, it may be driven by another pump in operation.  
Severe cuts may be caused on contact.  
Before working on the pumping unit, it is recommended to:

- stop the pumping unit (main switch set 0),
- wait for all the components to stop,
- disconnect the mains power supply cable.

**⚠ WARNING**

When the main switch is set to 0, some electrical connections may still be live.  
Electrical shocks may cause severe injuries.  
Before working on the pumping unit, it is recommended to disconnect the mains power supply cable.

## Safety instructions

** DANGER**

When powering up an item of equipment containing capacitors loaded at over 60 VDC or 25 VAC, precautions must be taken at the connector pin access.

Electrical shocks may cause severe injuries.

Before working on the pumping unit, it is recommended to wait 1 minute after setting the main switch to 0.

** DANGER**

Always connect the AMD4C pump exhaust to an exhaust extraction system.

** CAUTION**

The pumping units are designed so as to prevent thermal risks for the user's safety.

However, particular operating conditions may induce temperatures justifying particular caution on the part of the user (outer surfaces > 70 °C on exhaust connections).

Burns may be caused on contact.

Wear protective gloves before repair work.

** DANGER**

Before executing maintenance operations, it is necessary to verify the pumping conditions: toxicity, corrosion of the pumping gases.

** WARNING**

The tightness of the product is guaranteed, when leaving the factory, for normal operating conditions.

If hazardous or corrosive gases are pumped, the user is responsible for ensuring the quality of tightness of the installation. This installation must prevent an over pressure in the pumping circuit.

** DANGER**

The manufacturer has no control over the types of gases passing through this pump. Frequently, process gases are toxic, flammable, corrosive, explosive or otherwise reactive. Since these gases can cause serious injury or death, it is very important to plumb the exhaust of the pump to the facility's hazardous gas exhaust system which incorporates appropriate filters, scrubbers, etc., to insure that the exhaust meets all air regulations.

Check that pump is correctly connected to the equipment.

## Safety instructions

** DANGER**

For safety reasons, any accessories connected to the inlet and exhaust must be made of materials compatible with pumped gases. Ensure that the gases being used are compatible with pump's materials. See sheet  A 20

**CAUTION**

When the diaphragm pump is new, or has been in storage for a shutdown period of 2 months or more, we recommend to switch on the diaphragm pump for approximately 5 min. at atmospheric pressure, then 10 min. at limit pressure. This will evacuate potential moisture built up in the pump.

**CAUTION**

The pumping units must be used only in the industrial area, in compliance with the standard EN din 294 table 4 for persons over 14 years.

** WARNING**

The pumping unit can pump air with steam. It must not pump water, other liquids, fumes, corrosive flammable gases. The pumpin unit must not be operate in the aeras where then is a exploision risk. Contact center service to adapt the pumping unit.

## Unpacking, storage

### Precaution

Unpack the equipment carefully and keep the packaging. Make sure that the equipment has not been damaged during transport. If it has been damaged, take the necessary measures with the transport operators and notify manufacturer if required. In any case, we recommend that you keep the packaging (recyclable material) to transport the equipment if required or in the event of prolonged storage.

- To keep your product in the state of cleanliness in which it left our factory, we recommend to only unpack the pumping unit on its installation site. The unpacking and assembly operations must be performed in a single sequence.
- Risk of toppling over: compliance with EEC safety regulations is guaranteed (normal range  $\pm 10^\circ$ ). However, it is recommended to take precautions to prevent the risk of the equipment toppling over during handling, installation and operation.

### Packaging contents

The packaging contains the following packaging units:

- The pumping unit instruction manual.
- The Drytel 1025 pumping unit.
- The mains power supply cable.

Note: All accessories ordered will be delivered separately.

### Unpacking

Be sure to remove the foam packing particularly the wedge under AMD1 pump.

### Pumping unit storage

The Drytel 1025 pumping unit can be stored without any particular precautions (ambient temperature between  $-10$  and  $+ 60$  °C).

See sheet  **A 40**

Inlet flange must be closed for prevent foreign bodies or moisture from entering pump.

**Note: If the exhaust connection option is installed, it is also recommended to seal the DN 16 exhaust flange.**

## Mechanical connection

### Preliminary recommendations

#### CAUTION

- Read carefully the safety instructions. See sheet  B 10

Remove the protective seals on the inlet, and if applicable, exhaust orifices:

These components prevent foreign bodies from entering the pump during transport and storage.

It is dangerous to leave them on the pump in operation.

- Make sure that the working confinement is clean and free of “solid particles”.  
These particles could damage the secondary pump.
- The performances of the pumping unit depend on the type of accessories used and the quality of the mechanical connections.
- For different reasons, the cleanliness of the materials and seals used on the inlet and exhaust lines must be compatible with the gases pumped.
- Make sure that the chambers or confinements connected to the pumping unit inlet can withstand a negative pressure of 1 bar with reference to atmospheric pressure.

### Positioning the pumping unit

- The work surface on which the pumping unit is installed must be sufficiently rigid to prevent any vibration
- Due to the use of the primary and secondary pumps, check that the group is placed in a ventilated place, and that the events are free. The work at high pressure or in pumping cycles increases the temperature of the pump.  
The reliability of the pumps can be reduced by a high ambient temperature.
- Risk of toppling over: compliance with EEC safety regulations is guaranteed (normal range  $\pm 10^\circ$ ).
- However, it is recommended to take precautions to prevent the risk of the equipment toppling over during handling, installation and operation.

## Mechanical connection

**Inlet** Inlet flange can carry a maximum weight of 30 kg.

Connect the intake flange of the secondary pump to the equipment with help of accessories adapted to the type of pump.

See sheet  **A 60** Accessories.

**Exhaust** The pumping unit exhaust is provided:

- either via a silencer filter,
- or via a DN 16 ISO K exhaust end fitting (optional).

See sheet  **A 50** Options.

Various DN 16 connection accessories are available in the Adixen catalogue.

### Automatic air ballast (option)

To connect the neutral gas line, unfasten the air inlet filter, and connect the neutral gas at the 1/8G connection.

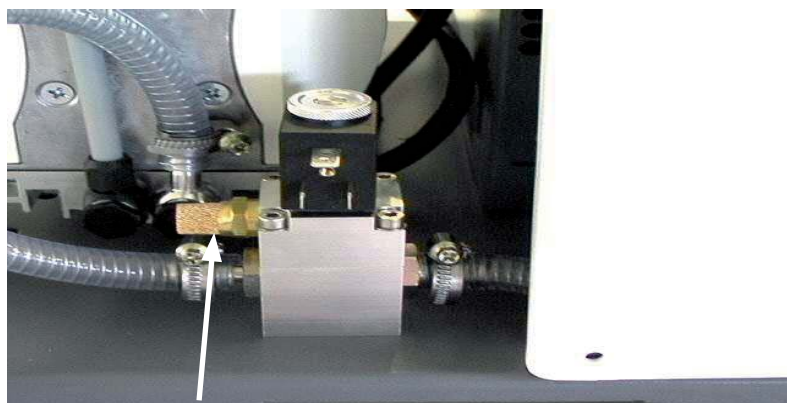

Air inlet filter

See sheet  **A 20** Description

See sheet  **C 40** Using automatic air ballast.

## Electrical connection

### Preliminary recommendations

- Read carefully the safety instructions. See sheet  B 10

#### DANGER

When powering up an item of equipment containing capacitors loaded at over 60 VDC or 25 VAC, precautions must be taken at the connector pin access.

Electrical shocks may cause severe injuries.

Before working on the pumping unit, it is recommended to wait 1 minute after setting the main switch to 0.

#### WARNING

When the main switch is set to 0, some electrical connections may still be live.

Electrical shocks may cause severe injuries.

Before working on the pumping unit, it is recommended to disconnect the mains power supply cable.

#### WARNING

It is dangerous to access the rotor of a turbomolecular pump on which the intake is not connected.

Even if the pump is not powered, it may be driven by another pump in operation.

Severe cuts may be caused on contact.

Before working on the pumping unit, it is recommended to:

- stop the pumping unit (main switch set to 0),
- wait for all the components stop,
- disconnect the mains power supply cable.

### Mains voltage check

- Check that the information on the label beside the mains connector complies with the network on which the pumping unit is installed.
- Otherwise, make the necessary modifications.  
See sheet  E 30

### Connection

- Check that the drytel 1025 is set to the local mains voltage. If not see sheet  E 30
- Connet the main power cable to drytel 1025.

If the pumping unit is equipped with the remote control option, see sheet  B 50



---

## Electrical connection

### Air ballast connection

The electrical connection of 24 V DC valve is done through a DIN connector.  
(Wiring, power supply and command are supplied by the customer).

**CAUTION**

**The power supply of 24 V DC valve must be done independently of Drytel 1025 electronical.**

This valve is normally closed.

## Connecting the remote control connector (option)

### Preliminary recommendations

- Read carefully the safety instructions. See sheet  B 10
- The internal part of the pumping unit containing the control electronics is equipped with dry contact outputs.
- It is the customer's responsibility to use these outputs in compliance with safety standards.

### Location of the remote control connector

The remote control is connected via the male remote control connector on the side of the pumping unit.

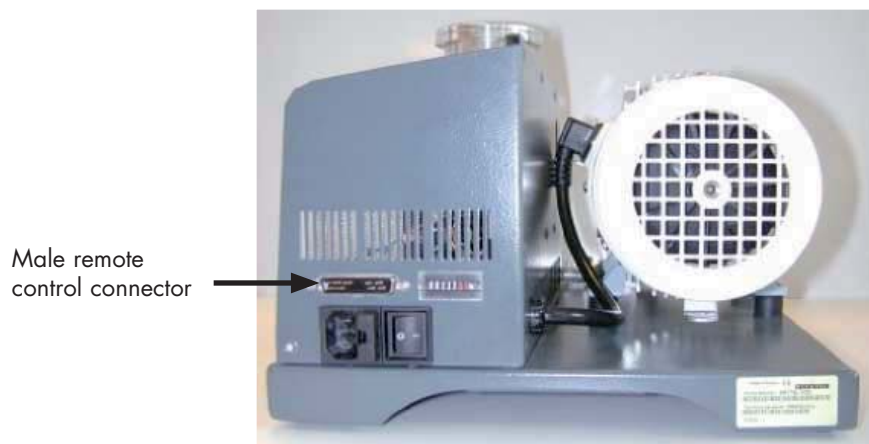

## Connecting the remote control connector (option)

### Wiring to use the pumping unit in remote control mode

The voltage is supplied by the customer. These outputs are open collectors.

Contact	Function	Voltage	Current
I <sub>1</sub>	Primary pump On/Off control.	5 V DC ± 5%	500 μA
I <sub>2</sub>	Secondary pump On/Off control.	5 V DC ± 5%	500 μA
LD1	Red indicator light: the secondary pump is faulty.	30 V DC	40 mA
LD2	Green indicator light: the secondary pump has reached its synchronism speed.		
LD3	Yellow indicator light: the secondary pump is increasing speed.		

If the pumping unit is used in remote control mode, wire the remote control connector (supplied by customer) according to the diagram below, take off the mask and connect it to the male remote control connector.



## Connecting the remote control connector (option)

25-pin female sub-D connector type remote control connector soldered side view

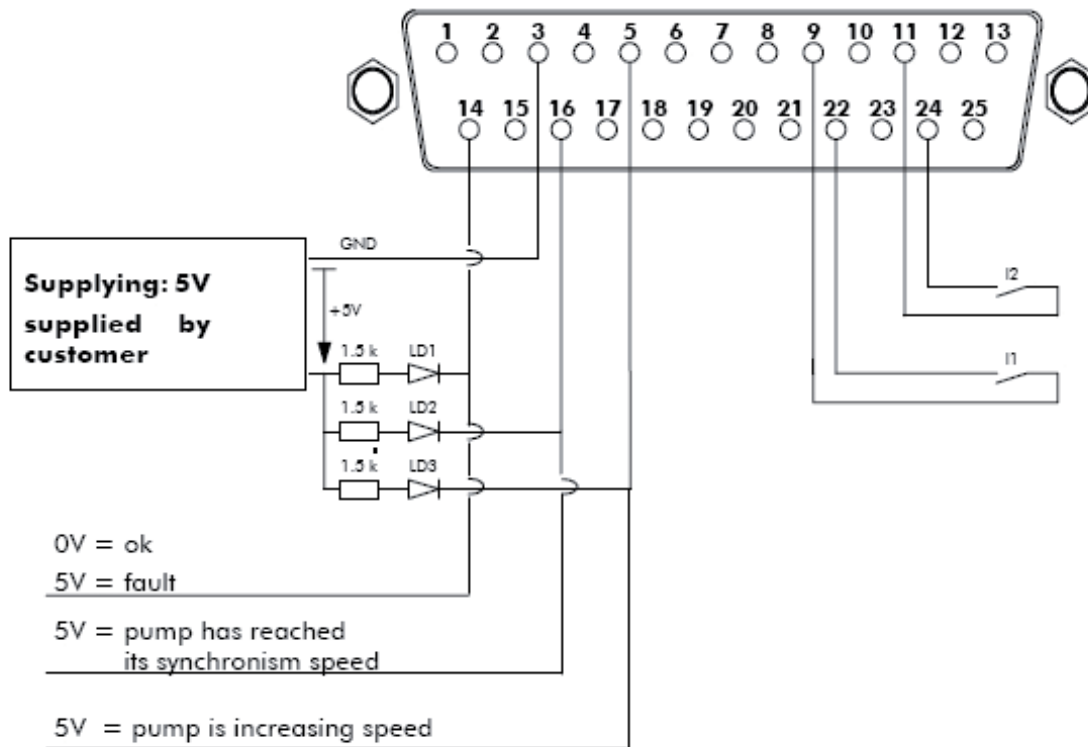

### Connection to use the pumping unit in local mode

If the pumping unit equipped with the remote control option is used in local mode, take off the mask and connect the plug connector (supplied by the manufacturer and according to the diagram below) to the male remote control connector.

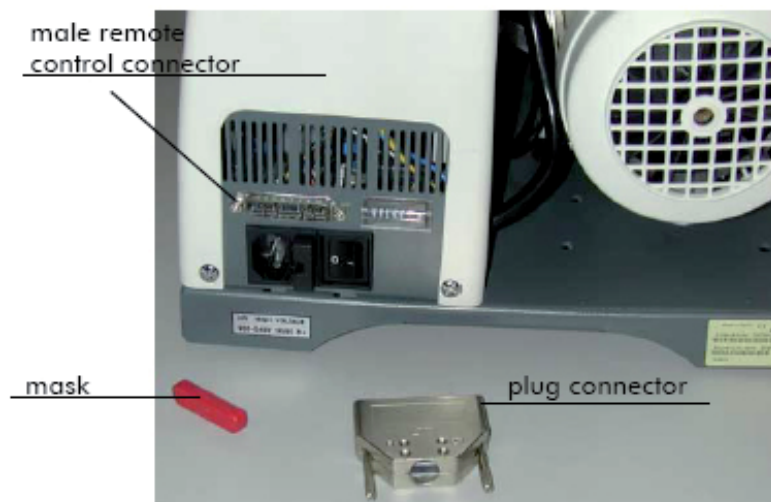

## Connecting the remote control connector (option)

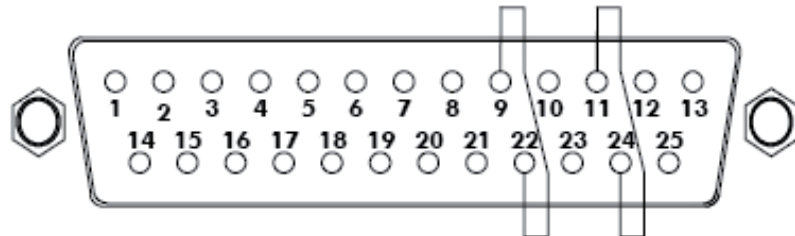

25-pin female sub-D connector type plug connector  
Soldered side view

Contact	Function
9 - 22	Primary pump operation
11 - 24	Secondary pump operation

## Safety instructions

### Preliminary recommendations

- Read carefully the safety instructions. See sheet  B 10

Do not move or induce a shock on a pump in operation. This could result in a risk of jamming.

### CAUTION

The pumping units are designed so as to prevent thermal risks for the user's safety.

However, particular operating conditions may induce temperatures justifying particular caution on the part of the user (outer surfaces > 70 °C on exhaust connections).

Burns may be caused on contact.

Wear protective gloves before repair work.

### WARNING

It is dangerous to access the rotor of a turbomolecular pump on which the intake is not connected.

Even if the pump is not powered, it may be driven by another pump in operation.

Severe cuts may be caused on contact.

Stop the pumping unit, wait for all these components to stop completely and disconnect the power supply cable before any intervention on the equipment.

### First pumping unit rotation (running in)

### CAUTION

When the secondary pump is new, or after a storage for a shutdown period of 2 months or more, we recommend to start the secondary pump for approximately 10 min at atmospheric pressure by setting the main switch to 1.

Then let the pump running for 20 minutes at ultimate pressure.

The purpose of this slow rotation is to distribute the grease regularly in the ball bearings.

## Using the pumping unit in local mode

### Preliminary recommendations

- Read carefully the safety instructions. See sheets  B 10 and  C 10

### Procedure

This procedure is intended for a pumping unit on which the remote control option has not been installed.

Otherwise, follow the instructions. See sheet  C 30

### Starting up the pumping unit

- Check that inlet valve is closed.
- Check that the primary pump switch is set to 1.
- Set the main switch to 1.

The following operations take place: the primary pump, fan and then the secondary pump (2 seconds after the primary pump) start up.

**The status of the indicator lights (on or off) reflects the operating status of the pumping unit and more specifically the speed of the secondary pump.**

### Start-up phase

*Pumping unit start-up*



#### Time T

Main switch set to 1.

The various parts of the pumping unit start up.

*Pumping unit speeds up*



#### Time T + 2 sec

The turbomolecular pump speeds up to reach its synchronism speed.

*The secondary pump has reached its synchronism speed*

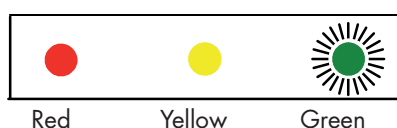

#### Time T + 2 min

The pumping unit is ready for operation.

## Using the pumping unit in local mode

### Phase liable to take place during pumping

#### Following air entry

*Pumping unit speeds up*



When a high volume is pumped, or if the pumping unit is at high pressure, the secondary pump will slow down and lose its synchronism.

*The secondary pump has reached its synchronism speed*

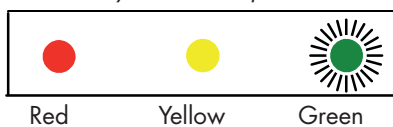

Once the pressure conditions are restored, the pump returns to its synchronism.

#### A technical incident occurs

*The pumping unit is faulty*

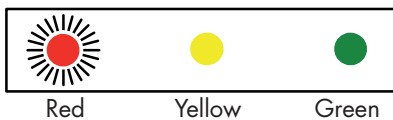

See sheet  **D 30**

### Stopping the unit pumping

- Close the shutt off valve.
- For evacuate completely the pumping gases, let working the pumping unit during 15 to 30 min.

### Shutdown phase

*The pumping unit stops*

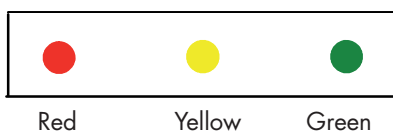

**Time T + n**

- Main switch set to 0.

The various parts of the unit stop: primary pump, fan and secondary pump stop simultaneously.



## Using the pumping unit in remote control mode (option)

### Preliminary recommendations

- Read carefully the safety instructions. See sheets  B 10 and  C 10

### Different control modes

The pumping unit may be:

- controlled locally using the main switch,
- controlled remotely by dry contacts using the remote control connection.

### Local mode

To enable operation in local mode of a pumping unit equipped with the remote control option: connect the plug connect to the male remote control connector on the side of the pumping unit.

In this type of operation, the pumping unit is completely autonomous in relation to the equipment in which it is installed.  C 20

### Remote control mode

To enable the operation in remote control mode of the pumping unit: connect the remote control connector to the male remote control connector on the side of the pumping unit See sheet  B 50

In remote control mode, the remote control connection makes it possible to copy the status of the indicator lights.

The information is interpreted according to the description. See sheet  C 20

### Starting-up the pumping unit

- Plug in the mains power supply cable.
- Set the main switch to 1. The fan starts up.
- The start-up of the primary and secondary pumps is controlled remotely by opening and closing the various dry contacts wired on the remote control connector. See sheet  B 50

---

## Using the pumping unit in remote control mode (option)

### Stopping the pumping unit

- The shutdown of the primary and secondary pumps is controlled remotely by opening and closing the various dry contacts wired on the remote control connector. See sheet  **B 50**
- Set the main switch to 0. The fan stops.

## Using the automatic air ballast (option)

### Procedure

- Start-up phase** Start the pumping unit and let it work 1 hour at ultimate pressure to get its temperature working.  
Open the automatic gas ballast to increase the pump temperature during 15 minutes. Pump the condensable gases.
- Shutdown phase** Let the pumping unit works with the gas ballast opened during 15 minutes to flush it.  
Close the air ballast and let the pumping unit works in pressure during 15 minutes to dry it.  
In case of important pollution, disconnect the primary pump and let it pumps for 1 hour on dry gas purge.  
Reconnect the primary pump, then let the pumping unit works in ultimate pressure for dry it.

### WARNING

In every case, in function of the pumped gas, connect the exhaust end fitting at an extraction or at a scrubber.  
For safety reasons, if the gas is corrosive, check that the gas pipe before and after the pumping unit is made of compatible material with the gas.  
If the gas is toxic, check that used materials are compatible with the requested leakness level.  
If necessary, install a purge at the exhaust of the pumping unit to dilute the gas and protect the exhaust from the moisture.

## Maintenance safety instructions

- Read carefully the safety instructions. See sheets  B 10 and  C 10

### CAUTION

Before any maintenance operation on a product performed by a maintenance operator not qualified on safety regulations (EMC, electrical safety, chemical pollution, etc.), shut off the product from its different power sources (electricity, compressed air, etc.).

### DANGER

When powering up an item of equipment containing capacitors loaded at over 60 VDC or 25 VAC, precautions must be taken at the connector pin access. Electrical shocks may cause severe injuries. Before working on the pumping unit, it is recommended to wait 1 minute after setting the main switch to 0.

### WARNING

When the main switch is set to 0, some electrical connections may still be live. Electric shocks may cause severe injuries. Before working on the pumping unit, it is recommended to disconnect the mains power supply cable.

### WARNING

Before performing maintenance operations, it is necessary to check the pumping conditions: toxicity, corrosion of the pumped gases.

### WARNING

The tightness of the products is guaranteed when leaving the factory for normal operating conditions. If hazardous or corrosive gases are being pumped, the user is responsible for ensuring the quality of tightness.

### WARNING

It is dangerous to access the rotor of a turbomolecular pump on which the intake is not connected. Even if the pump is not powered, it may be driven by another pump in operation. Severe cuts may be caused on contact. Before working on the pumping unit, it is recommended to:

- stop the pumping unit (main switch set to 0),
- wait for all the components stop,
- disconnect the mains power supply cable.

## Troubleshootings and remedies

### Identification of anomalies

- When a fault appears, the operator is informed by :
- The indicator lights status in rear panel of pumping unit, See sheet  **C 20**
- The information received from remote control connection, if the unit is equipped with remote control option.
- A noise or abnormal comportment of pumping unit.

Incident	Symptom	Cause	Action	Sheet
1	The pumping unit is not operating.	The mains power supply cable is not correctly connected.	Connect the mains power supply cable.	<b>B 40</b>
		The main switch is set to 0.	Set the main switch to 1.	<b>C 20</b>
		The fuse has blown.	Check the condition of the fuse and replace it if necessary.	<b>E 30</b>
2	The primary pump is not operating or not operating correctly.	The primary pump switch is set to 0.	Set the primary pump switch to 1.	<b>C 20</b>
		Incorrect primary pump power supply voltage selection.	Correct the primary pump power supply voltage.	<b>E 30</b>
		The pumping unit has heated up.	Cool down pumping unit. Remedy the fault and start again.	/
		There was an over-pressure at outlet.	Check canalisation and accessories at the outlet of the pump.	/
		The pumping unit is polluted.	Dissassemble the pump, clean it and change diaphragms.	<b>E50 AMD1 E51 AMD4</b>
3	The secondary pump is not operating.	Incorrect power supply. <b>The indicator lights do not come on.</b>	Contact the service centre	/
		The pumping unit has heated up. <b>The red indicator light comes on.</b>	Wait for the pumping unit to return to ambient temperature.	/
		The secondary pump is faulty.	Contact the service centre.	/

## Troubleshootings and remedies

Incident	Symptom	Cause	Action	Sheet
4	The secondary pump is not operating correctly. (start-stop)	<i>The variator board is faulty. <b>The red indicator light comes on.</b></i>	Contact the service centre.	/
		Fault on the main board. <b>The indicator lights do not come on.</b>	Contact the service centre.	/
5	The pumping unit has a incorrect ultimate vacuum	There is a leak on the installation. <b>The yellow indicator light may come on.</b>	Check the installation and shut off the pumping unit to confirm that it is operating correctly.	/
		There is a leak on the pumping unit. <b>The yellow indicator light comes on.</b>	Check the condition of the tubes and their attachment.	E 40
		The primary pump diaphragms are faulty.	Shut off the primary pump. Check that the limit vacuum is greater than 5 mbar. If so, carry out maintenance.	E 50
		Other.	Contact the service centre.	/
6	The secondary pump is noisy.	The bearings are not greased correctly.	Operate a new running-in procedure.	C 10
			Regrease or change the bearings.	MDP 5011 E 60
				ATH 31+ Contact the service center
7	The primary pump is noisy.	The primary pump is at high pressure.	See action for incident 5.	/
		The primary pump is not powered correctly.	See action for incident 4.	/

## Maintenance frequencies

### CAUTION

Some maintenance operations require mechanical know-how and must be performed by qualified personnel.  
In the event of doubt, these operations may be carried out by a service centre.

### Primary pump

The frequency at which the primary pump depends on the context in which the pumping unit is used.

Under difficult conditions (pumping of condensable products, operation in high ambient temperatures, etc.), the maintenance frequencies given below should be reduced.

Frequency	Pump	Operation to be carried out	Sheet
Every 2 years	Primary	Replacement diaphragms and chek valves of <b>primary pump</b>	<b>AMD1 E 50</b> <b>AMD4 E 51</b>
Every 2 or 3 years	Drytel	Replacement of <b>primary pump / secondary pump</b> pipe	<b>E 40</b>
26000 hours	Secondary	Replacement of bearings of the <b>ATH31 + pump</b>	Contact the service center
Frequency must be defined .It depends on the using conditions (See page following)	Secondary	<b>MDP 5011 pump</b> Grease refill Pump disassembly Cleaning and bearing replacement.	<b>E 60</b>

### Secondary pump

The pump grease refilling and bearing replacement periods depend on their use.

- 5011 MDP, bearing refill,
- ATH31+, bearing replacement.

## Maintenance frequencies

### Maintenance example

### MDP 5011 pump



Stabilisation temperature measurement point

Frequencies	Operation to be carried out	Sheet
16 000 hours	First grease refill	E 60
32 000 hours	Second grease refill	E 60
48 000 hours	Pump disassembly	E 60
	Cleaning and bearing replacement	F 10
	Running-in	E 60

### Grease refilling scale (MDP 5011 pump)

- In continuous rotation, at limit pressure
- - - In cycle  $\leq 1$  hour, at maximum inlet pressure.

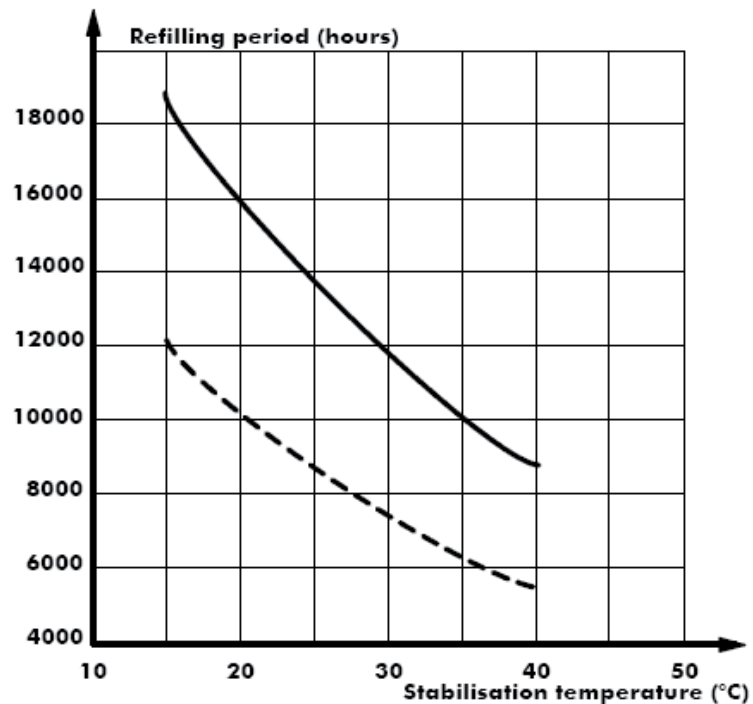

For a temperature at **20 °C**, the frequency is :

- 16 000 hours **in continuous rotation**,
- 10 000 hours in **cycle**.





For a temperature of **35 °C**, the frequency is :

- 10 000 hours **in continuous rotation**,
- 6 300 hours in **cycle**.



---

## Pumping unit dispatch procedure

- Read carefully the safety instructions. See sheets  B 10  C 10 and  D 10
- Seal the inlet and exhaust ports using the protections removed during the mechanical connection.
- These components will prevent foreign bodies from being introduced into the pump during transport and storage.
- Remember to complete the «**safety questionnaire**» and return it to the repair service centre. See sheet  G 10
- To protect the pumping unit during transport:
  - please use the original packaging,
  - or hire a packaging specialist.
- This packaging may be ordered P/N: 108992.

**Note: A product damage during its return, with not adapted packaging, will be not guaranteed.**

## Electrical configuration selection

- Read carefully the safety instructions. See sheets  B 10  C 10  D10

### Parameter selections

- Unfasten and remove the four M 4 - 10 housing attachment screws.
- Remove the housing.

### Power supply board

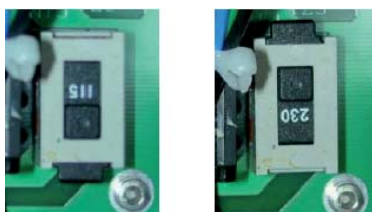

- Set the switch to the suitable voltage.
  - LV = 115 V (100 V - 115 V)
  - HV = 230 V (200 V - 220 V - 230 V - 240 V)

### Diaphragm pump



- Set the switch to the suitable voltage.
- LV = 115 V (100 V - 115 V)
  - HV = 230 V (200 V - 220 V - 230 V - 240 V)

### Power supply unit



- Remove the fuse holder from the power supply unit by pressing its tab.
- Install the suitable fuse.

	AMD1	AMD4
LV	4 A	6.3 A
HV	2 A	3.15 A

- Replace the fuse holder (by snapping it on) in its housing in the power supply unit.
- Position the housing.
- Fasten the four M 4 - 10 housing attachment screws.

## Pumping unit maintenance

- Read carefully the safety instructions. See sheets

 B 10    C 10    D 10

### Replacing the pipe

#### Cowling disassembly

- Unfasten and remove the four M 4 - 10 cowling attachment screws.
- Remove the cowling.

#### Tube disassembly

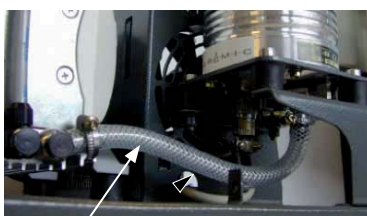

Tube

- Unfasten the clamping collar on the intake side tube of the primary pump.
- Release the intake side tube from the primary pump.
- Retrieve the clamping collar.
- Unfasten and remove the four CHC M 6 - 10 screws attaching the secondary pump onto its support.
- Remove the four M 6 washers.
- Unfasten and remove the nut ground cable attachment screw.
- Remove the M 6 washer.
- Release the ground cable.
- Disconnect the secondary pump/converter board connection cable.
- Unfasten the clamping collar on the exhaust side tube of the secondary pump.
- Release and discard the tube.
- Retrieve the clamping collar.



---

## Pumping unit maintenance

- Tube reassembly**
- Insert the retrieved clamping collars at each end of the new tube.
  - Fit one side of the new tube onto the connection fitting of the secondary pump so that it comes to a stop.
  - Tighten the retrieved clamping collar half-way up the connection fitting.
  - Connect the secondary pump/converter board connection cable.
  - Position the ground cable.
  - Keep it in position using the CHC M 6 screw equipped with its M 6 washer.
  - Position the secondary pump on its support (exhaust side tube of secondary pump facing front of pumping unit).
  - Fasten the four CHC M 6 - 10 screws equipped with their M 6 washer, taking care not to crush the shock mounts.
  - Fit the other side of the new tube onto the connection fitting of the primary pump so that it comes to a stop.
  - Tighten the retrieved clamping collar half-way up the connection fitting.

- Cowling reassembly**
- Position the cowling.
  - Fasten the four M 4 - 10 cowling support screws.

## AMD1 Diaphragm pump maintenance

- Read attentively the safety instructions outlined in sheet  B 10
- The tools and maintenance components required are outlined in a specific chapter  F 10

### DANGER

Never use vacuum grease (the grease can catch gases which can explode on contact with oxygen), or a not soft lintfree fabric (lint can disturb the working of the valves).

### Disassembling the pump from its support

Disconnect inlet port of the diaphragm pump and remove it from its support.  
Disconnect the exhaust port (if necessary) of the diaphragm pump.

### Replacing check valves and diaphragms

### CAUTION

It is recommended, when replacing diaphragms, to disassemble and reassemble each of the diaphragms in succession, so as not to invert the parts of one subassembly with another during reassembly, in particular possible locking washers.

### Diaphragm pump breakdown view

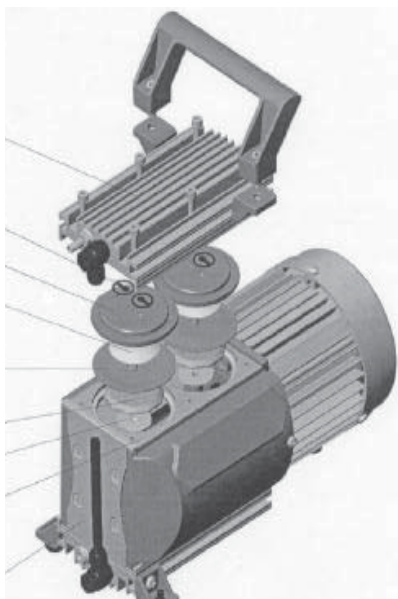

## AMD1 Diaphragm pump maintenance

### Connector disassembly



While holding the banjo fitting using the 16 mm flat wrench, unfasten and release the upper connector using the 14 mm flat wrench.

Perform the same procedure for the lower connector.

### Check valves disassembly

Unscrew and remove the 6 C HC M 5 - 20 casing cover screws.

#### CAUTION

Head covers and valves may come with the casing cover : proceed delicately and identify the valve position on the head cover.

Remove the top part of the casing (casing cover, head covers).  
Separate the head covers from the casing cover.  
Remove and discard the used valves.  
Clean the valve seats with alcohol. Refer to F 10

### Diaphragm disassembly

Using a seal extractor tool, lift two opposite sides of the diaphragm and insert the diaphragm wrench.

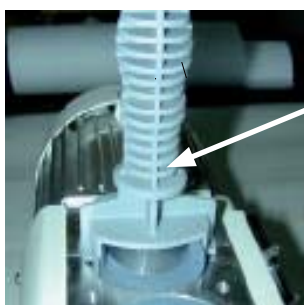

Diaphragm wrench

**Note:** for the following maintenance step, proceed delicately: the adjusting washer installed under the diaphragm may fall into the pump body.

Press the diaphragm wrench on the attachment disk and then unfasten and carefully remove the attachment disk/diaphragm/support disk and adjusting washer subassembly.

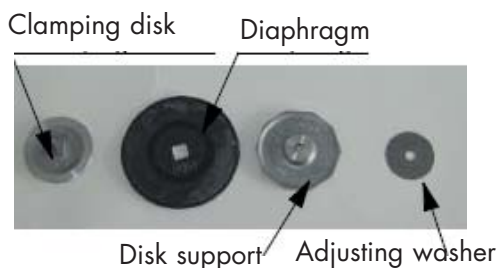

Separate the diaphragm from the clamping disk and the support disk and discard it. Clean the adjusting washer.

Clean the diaphragm seats with alcohol.  
See sheet F 10



Rod

## AMD1 Diaphragm pump maintenance

### Diaphragm reassembly



A drop of adhesive

Insert the new diaphragm between the attachment disk and the disk support.

**Take care to position the tight side of the diaphragm on the attachment disk side.**

Lift two opposite sides of the diaphragm so as to insert the attachment disk/diaphragm/support disk in the diaphragm wrench.

**Take care not to scratch or mark the diaphragm on the sealing side during this operation.**

Apply a drop of adhesive (Omnifit 50 M or Loctite 243) to thread of screw of diaphragm clamping disc.

If required, position the lock washer identified during the disassembly on the connection rod.

**Fasten the attachment disk/diaphragm/disk support subassembly. Take care that the adjusting washer do not fall into the pump body when the subassembly is performed.**

Remove the diaphragm wrench.

Flatten the diaphragms.

### Check valve reassembly

Locate the position of head covers and casing cover.

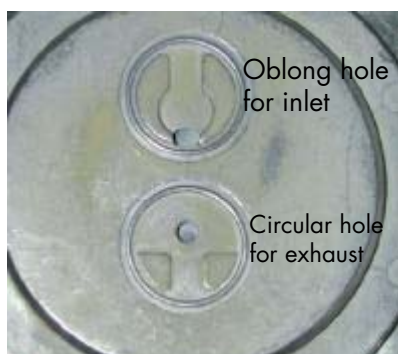

## AMD1 Diaphragm pump maintenance

Position the new adjusting valve in the head covers.



Position the equipped head covers in their casing housing.

Take care to observe their position (see photo).

Position the casing cover on the casing, shaking it slightly to ensure that the head covers are positioned correctly.

Fasten the six CHC M 5 - 20 screws in contact diagonally and then tighten: the maximum torque to be applied is **6 Nm**.

Note: At the end of tightening of the casing cover attachment screws, the cover must not be in contact with the casing.

### Connector reassembly

#### CAUTION

When disassembling and reassembling the connectors, be careful not to damage the aluminium's threading. Ensure the good position of the first net of the connector in fastening by the hand, before using the wrench. Always use 2 flat wrenches to fasten the bandjos.

While holding the banjo fitting using the 16 mm flat wrench, fasten the upper connector using the 14 mm flat wrench.

Perform the same procedure for the lower connector.



---

## AMD1 Diaphragm pump maintenance

### Reassembling the pump on its support

Check that the ultimate pressure of the diaphragm pump is lower than 2 mbar. Refer to  **B 30**.



Install the diaphragm pump on its support.  
Connect the inlet port according to the installation.  
Connect the exhaust port (if necessary).

#### CAUTION

If the ultimate pressure is not reached :

- In case of diaphragms and valve replacements, a running in period of some hours is necessary before reaching the ultimate pressure.
- After the running in period, if the ultimate pressure is 2 mbar different from the technical data, check the leaks on pipes between the different stages and connectors.

## AMD4 and AMD4C Primary pump maintenance

- Read attentively the safety instructions outlined in sheet  B 10
- The tools and maintenance components required are outlined in a specific chapter.  F 11

### DANGER

Never use vacuum grease (the grease can catch gases which can explode on contact with oxygen).

### ATTENTION

Never use a lintfree fabric (lint can disturb the working of the valves).

### Disassembling the pump from its support

Disconnect inlet port of the diaphragm pump from the pumping line. Disconnect the exhaust port of the diaphragm pump from the exhaust line (if connected).

### Replacing check valves and diaphragms

### CAUTION

When replacing diaphragms, it is recommended, to disassemble and reassemble successively one after the other to avoid any parts (possible if locking washers are present).

### AMD4 breakdown view

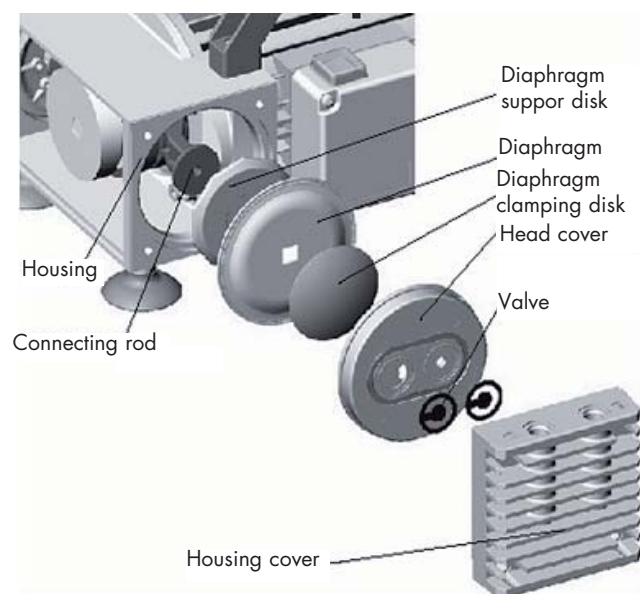

## AMD4 and AMD4C Primary pump maintenance

### Connector disassembly



While holding the banjo fitting using the 20 mm flat wrench, unfasten and release the upper connector using the 17 mm flat wrench. Perform the same procedure for the lower connector. Unscrew and disassemble the connectors and their washers.

### Check valve disassembly

**Note:** To unfasten the diaphragm and check valve, put pump on its side horizontal position.

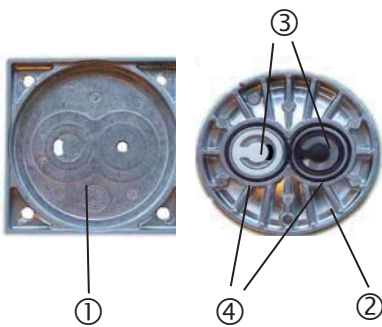

Unfasten and remove the 4 CHC M6 casing cover screws. Remove the top part of the casing (casing cover (1), head cover (2)). Separate the head cover (2) from the casing cover (1).

**Note:** Check the position of the valves on the head covers.

Remove and discard the used valves (3).  
Check the o-ring (4) and change it if necessary.  
Clean the valve seats with alcohol.

### Diaphragm disassembly

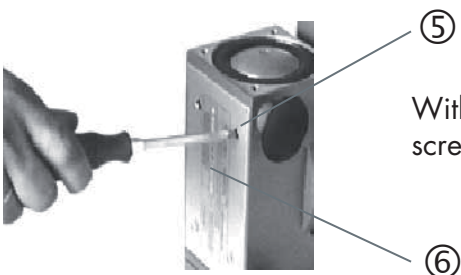

With a screwdriver for recessed head screws (5), unfasten the 4 screws and remove the flange of the housing (6).

## AMD4 and AMD4C Primary pump maintenance



Use hammer blow on a sharp tool to unblock the diaphragm support disk. See photo.



Unfasten the diaphragm clamping disc with the face wrench diameter 4 (Ref 117B Facom).

**Note:** If the disassembly of the diaphragm is difficult, position the rod at the upper position and push the diaphragm from the inside of the housing.

**Never use a sharp tool to separate the diaphragm and the clamping disk.**

### Diaphragm reassembly

Position new diaphragm (7) between diaphragm clamping disc (8) with square head screw and diaphragm support disk.(5) .

**Note:** The AMD4 diaphragm is constituted of 2 disks positionned clear face against clear face.  
Don't separate them.

Check for washers under clamping disk. Put them on the screw of the diaphragm clamping disk.  
Apply a drop of adhesive (Omnifit 50 M or Loctite 243) to thread of screw of diaphragm clamping disk.

## AMD4 and AMD4C Primary pump maintenance

### Diaphragm reassembly

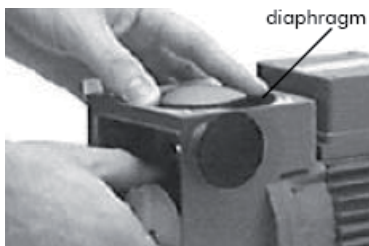

Push the rod to the lower position and center the diaphragm in the housing.



Use the face wrench to assemble diaphragm clamping disk, diaphragm and diaphragm support disk.

The torque is **6 Nm**.

On the head cover, install the o-ring on its groove and the 2 valves on their housing in the head cover.

Note: Ensure that the black valves and white valves are correctly positioned on the head cover.

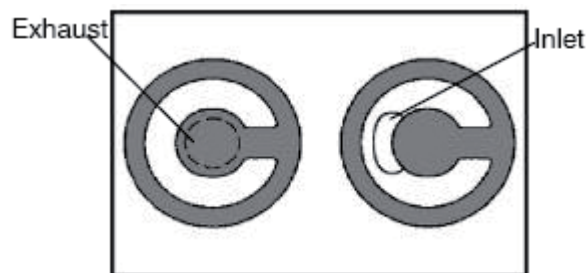
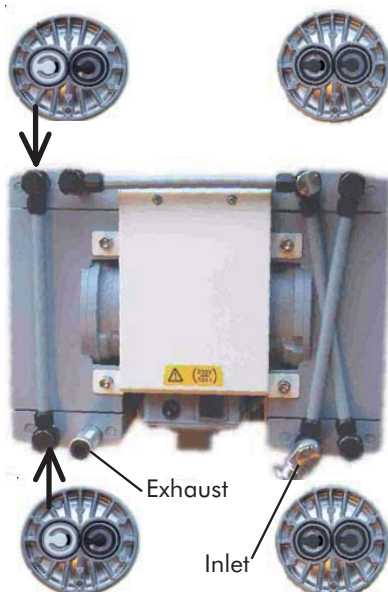

Position the housing cover on the head cover and check the polarizing slot.

Put the rod in the lower position.

Install this assembling on the housing and fasten the 4 CHC M6 screws.

**Note: Fasten the 4 CHC screws in contact diagonally and then tighten with a maximum torque of 10 Nm.**

**Note : Housing cover must not be in contact with the housing to avoid pump seizing.**

## AMD4 and AMD4C Primary pump maintenance

### Connector reassembly

Place the pipes between the stages by respecting their initial position.



Modèle AMD4

#### CAUTION

When disassembling and reassembling the connectors, be careful not to damage the aluminium threading. Ensure the good position of the first net of the connector in fastening by the hand, before using the wrench.

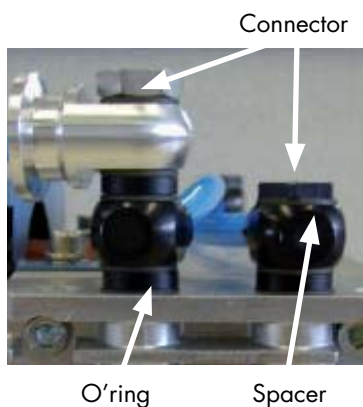

On the connector place first the seal washers, then the inlet port and the spacers.

While holding the banjo fitting using the 20 mm flat wrench, tighten the upper connector using the 17 mm flat wrench.

Repeat this procedure for each connector.

Secure the housing plate with the 4 screws.

Check the ultimate pressure of the pump. It must be lower than 2 mbar.

#### CAUTION

If the ultimate pressure is not reached :

- In case of diaphragms and valves replacement, a running in period of some hours is necessary before reaching the ultimate pressure.
- After the running in period, if the ultimate pressure is 5 mbar different from the technical data, check the leaks on pipes between the different stages and connectors.

### Reassembling the pump on its support

Connect the inlet port to the pumping line.

Connect the exhaust port to the exhaust extraction system (if necessary). Refer to  B 31

## MDP 5011 pump lubrication

The first greasing required for the correct operation of the secondary pump is performed in the factory.

Subsequent regreasings should be carried out according to the procedure below, according to a frequency defined according to the processes used. See sheet  **D 40**

### Greasing procedure

#### Cowling disassembly

- Unfasten and remove the four C M 4 - 10 cowling attachment screws.
- Remove the cowling.

#### Disassembling the secondary pump from its support

- Unfasten and remove the four CHC M 6 - 10 screws attaching the secondary pump to its support.
- Remove the four M 6 washers.
- Unfasten and remove the CHC M 6 ground cable attachment screw
- Remove the M 6 washer and release the ground cable.
- Disconnect the secondary pump/converter board connection cable.
- Unfasten, without removing them, the two H M 6 - 20 screws of the clamping flanges of the secondary pump exhaust side tube.
- Pivot the clamping flanges.
- Remove the exhaust flange and its seal holder ring.

#### CAUTION

Only use the grease recommended by the manufacturer and contained in the lubrication syringe.

#### CAUTION

Avoid introducing foreign matter into the pump during these operations. Lubrication must be performed with the pump switched off.

#### Refilling with grease

The secondary pump is equipped with two bearings. At each refill, the user must refill these two bearings.

The greasing syringe contains two jumpers:

- A black one for greasing the pumping cell side bearing.
- A red one for greasing the bearing opposite the pumping cell.

# MDP 5011 pump lubrication

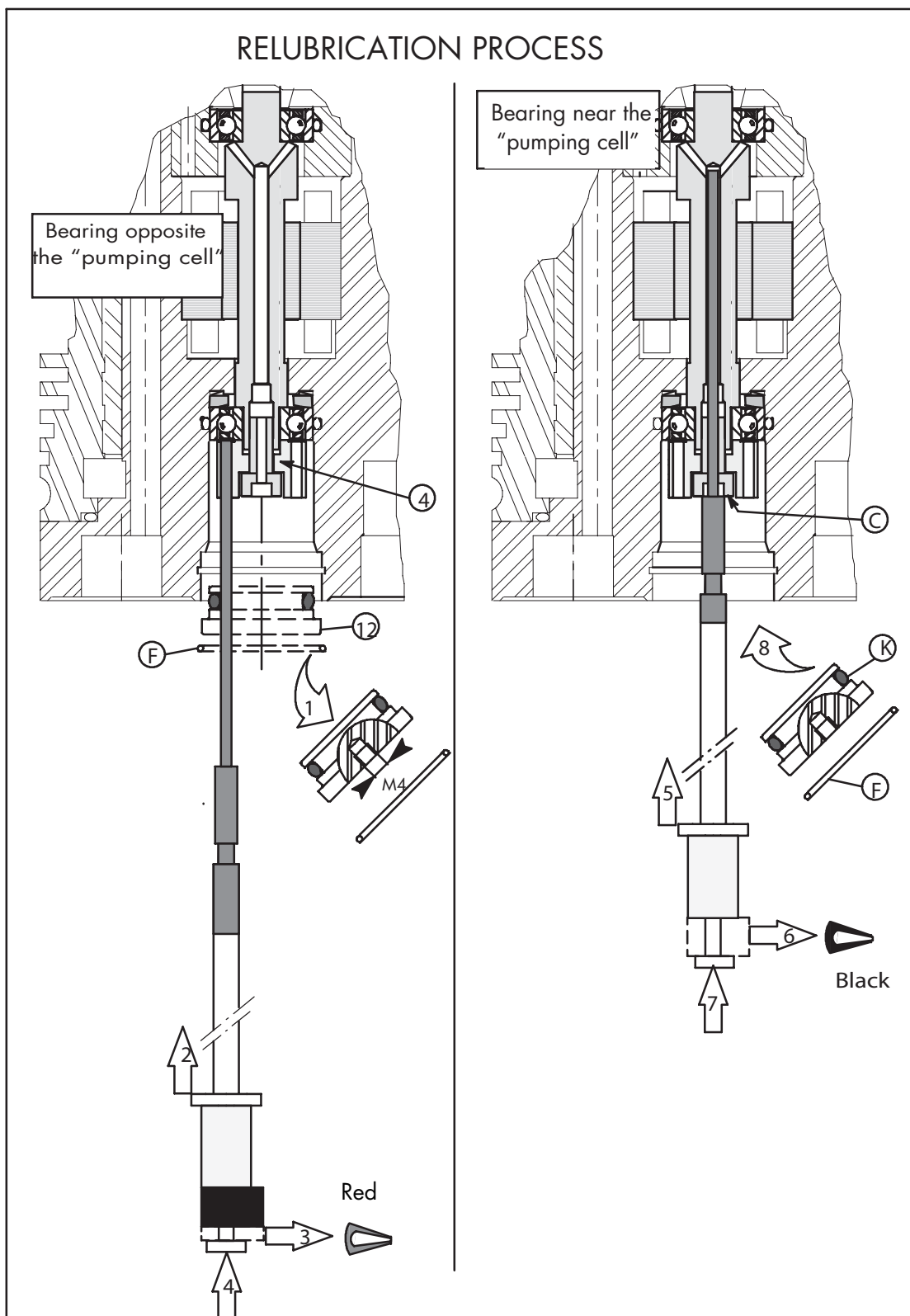



## MDP 5011 pump lubrication

### Refilling with grease

#### Greasing the bearing opposite the pumping cell

- Introduce the syringe equipped with its needle into a hole of the ring (4) and remove the red jump.
- Distribute the dose of grease in 2 diametrically opposed points, until the syringe plunger comes to a stop against the black jumper.
- Remove the syringe with its needle.

#### Greasing the pumping cell side bearing

- Introduce the lubrication syringe needle into the drilled screw located at the center of the rotor until it comes to a stop against the screw head.
- Keep the syringe pressed down to the bottom of its housing throughout the operation.
- Remove the black jumper from the syringe and introduce the grease until the plunger comes to a stop.
- Remove the syringe.
- Reassemble the end cap (12) and the lock pin (F).
- The relubrication operation is complete  **E 70**

#### Reassembling the secondary pump on its support

- Position the seal holder ring.
- Position the exhaust flange equipped with its seal holder ring
- Pivot the clamping flanges so as to hold the exhaust flange in position.
- Fasten the CHC M 6 - 20 screws.
- Connect the secondary pump/converter board connection cable.
- Position the ground cable.
- Hold it in position using the C HC M 6 screw using its M 6 washer.
- Position the secondary pump on its support (exhaust side tube of the secondary pump facing the front of the pumping unit).
- Fasten the four CHC M 6 - 10 screws equipped with their M 6 washer taking care not to crush the shock mounts.

**Note:** When positioning the exhaust flange, make sure that the clamping collar screw is inside the circle defined by the secondary pump.

---

## MDP 5011 pump lubrication

### **Cowling reassembly**

- Position the cowling.
- Fasten the four C M 4 - 10 cowling attachment screws.

### **Running after refilling with grease**

- After refilling with grease, it is essential to follow the secondary pump start-up instructions. See sheet  **E 70**

## Starting up the MD 5011 pump after refilling the bearings with grease

### CAUTION

After refilling the bearings with grease, it is essential to observe the different phases of the start-up procedure.

### Running in cycle

**First phase** Check that the secondary pump is connected to the pumping unit. The secondary pump must run initially for 2 x 3 minutes at atmospheric pressure.

### DANGER

During this operation, check that you have taken all the dispositions to forbid the contact of the fin of the rotor in rotation.

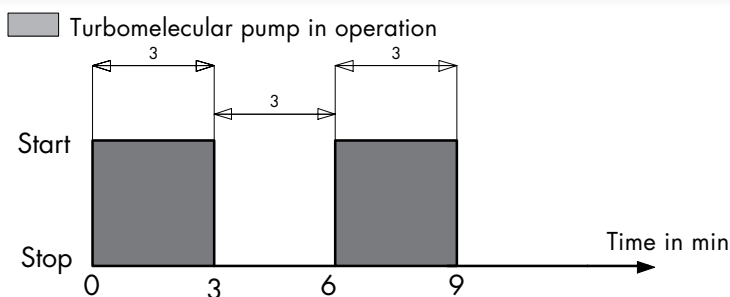

**Second phase** After completing the first phase, seal the secondary pump intake and perform the following running-in cycles (the second phase is carried out in a vacuum):

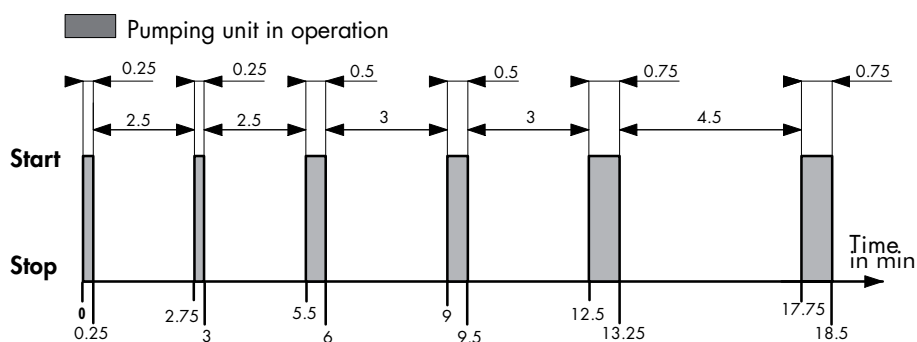

---

## Spare parts - Instructions of use

### Replacement of parts and use of non genuine parts

Our products are designed to comply with current EC regulations and guarantee optimal operating conditions with maximum safety conditions for the user.

**Any modification of the product made by the user is liable to lead to non-compliance with the regulations, or even to put into doubt the performance of the product and the user's safety.**

Replacement of defective components by other parts than genuine parts, and use of these parts, jeopardize the initial safety conditions of the equipment.

**In such case, the EC declaration of conformity becomes null: The manufacturer withdraws his responsibility for such operations.**

Besides, counterfeiting and unfair trading of parts are condemned under the civil and criminal laws.

The manufacturer urges the users not to take parts in the use of «imitations», in the misappropriation and pirating of intellectual property performed by some dishonest operators.

The manufacturer supplies maintenance components, spare parts or kits to perform the maintenance of its products (  F).

## Maintenance kit

### User's manuals

Description	P/N
AMD1 - AMD4 - ADMDC Primary pumps	109443
ATH31 + Secondary pump	108912
MDP 5011 Secondary pump	062199

### Standard tool

Description	P/N
Seal scoop (specific tool)	063285

### Other tools necessary

- Flat screwdriver
- Head screwdriver
- 10 - 14 - 16 - 17 - 20 mm flat wrenches
- 5 - 2.5 mm hexagonal wrenches
- 5 mm extended hexagonal wrenches
- Long-nose pliers-

### Spare parts

Description	P/N
2 A fuse	060522
3.15 A fuse	060855
4 A fuse	060851
6.3 A fuse	060860
Pumping tube	106796

### Power cables

Description	P/N
Europe	103566
U.K.	104411
Italy	104758
Switzerland	103718
U.S.A	103567
Connector 2p + T U.S.	106837

## Maintenance kit

### Primary pump

#### Maintenance kit

AMD1



AMD4

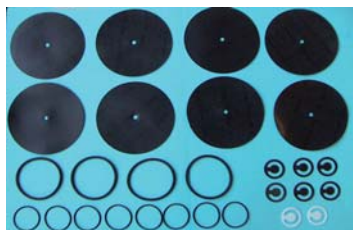

Description	P/N	
	AMD1	AMD4
Maintenance kit including : :	109149	110068
• Diaphragm	4	4
• Check valve	8	6 + 2
• O-ring 48 x 3	-	4
• O-ring 28 x 1,5	-	8

Keep this kit in a dry place, away from heat and light (sunlight and ultraviolet light), in order to prevent any hardening of the elastomers (see AFNOR standards : «storage conditions for vulcanized elastomer based products» - FD T.46 022).

#### Seal washer



AMD1

AMD4

Description	P/N	
	AMD1	AMD4
Seal washer (pce)	109528	106027
Qty by pump <b>Sold singly</b>	7	27

#### Silencer



AMD1

AMD4

Description	P/N	
	AMD1	AMD4
Silencer	114494	110035

## Maintenance kit

### MDP 5011 secondary pump

#### MDP 5011 specific tools

Description	P/N
Tool box	062172
Bearing replacement manual	062171

The tool box enables users to replace bearings. It contains the bearing replacement manual.

#### MDP 5011 maintenance kit

Description	P/N
Greasing syringe	056993
Seals kit	062194
Bearing kit	See § MDP 5011 bearing kit selection
Exhaust end fitting	A460519

#### MDP 5011 bearing kit selection

The ball bearings of the **MDP 5011** secondary pump may be replaced on the user's premises without requiring any dynamic balancing of the rotor.

### CAUTION

**However, this operation requires good mechanical know-how and must be performed by qualified personnel. In the event of doubt, this operation may be performed by a service centre.**

**Note :** To retain the balance of the pump, the tool box must be used to replace the bearings.



The bearings are selected according to two digits marked on the identification plate, after the secondary pump serial number.

The bearing kit part number will be determined by comparing the information on the identification plate. See the table below.

## Maintenance kit

### MDP 5011 bearing kit selection

Identification plate information	Bearing kit P/N (*)
1 (7.999)	066671
2 (7.998)	066672
3 (7.997)	066673
4 (7.996)	066674
5 (7.995)	066675

(\*) The bearing kit includes: the bearing, the O-ring and an elastic preload washer.  
The bearing clamping ring is included in the seal kit.



### Example

Alcatel  
Pump type : 5011  
Serial N° : 85501 - 55

└───┬───> Bearing reference

- The first digit **5** gives the pumping cell side shaft dimension, i.e. 7.995 mm.

Therefore, the part number of the pumping cell side bearing is 066675

- The second digit **5** gives the dimension of the shaft opposite the pumping cell, i.e. 7.995mm.

Therefore, the part number of the bearing opposite the pumping cell is 066675.



## Declaration of conformity

<b>DECLARATION OF CONFORMITY</b>	
<p>We, Alcatel Vacuum Technology France 98, Avenue de Brogny, BP 2069 74009 ANNECY FRANCE</p>	
<b>ISO 9001 CERTIFIED</b>	
<p>declare under our sole responsibility that the following products :</p>	
<p>DRYTEL 1025</p>	
<p>to which this declaration relates are in conformity with the following European Directives</p>	
<p>73 / 023 / EEC 89 / 392 / EEC 89 / 336 / EEC</p>	<p>Low Voltage Directive Machinery Directive Electromagnetic Compatibility Directive</p>
<p>The standards, normative documents, and/or specifications to which the products comply are :</p>	
<p>NF EN 60204-1</p>	<p>Safety of Machinery / Electrical Equipment of Machinery</p>
<p>NF EN 61000-3-2</p>	<p>EMC / Harmonic current emissions</p>
<p>NF EN 61000-4-11</p>	<p>EMC / For mains power cuts</p>
<p>NF EN 61000-4-2</p>	<p>EMC / Immunity to Electrostatic Discharges</p>
<p>NF EN 61000-4-4</p>	<p>EMC / Immunity to Transient Burst</p>
<p>ENV 50140</p>	<p>EMC / Immunity to Radiated Electromagnetic field</p>
<p>ENV 50141</p>	<p>EMC / Conducted disturbances induced by radio-frequency fields</p>
<p>ENV 50204</p>	<p>Radiated electromagnetic field from digital radio telephones - Immunity test.</p>
<p>NF EN 55011</p>	<p>EMC / Limits for electromagnetical conducted and radiated interferences</p>
<p>Mr J.Y. GUEGAN, Président Directeur Général </p>	
<p>Annecy, 10/05/01</p>	

## Safety questionnaire

### Procedure for returning ADIXEN vacuum pumps and helium leak detectors

You wish to return an Alcatel vacuum pump or helium leak detector for maintenance. The equipment will be dismantled and possibly cleaned by a technician from our Service Centre.

In compliance with European Community's L360 directives, French labor code L231 - R231 and Federal OSHA Safety Standard 1910-1200, Alcatel Vacuum Technology requires this form to be completed to preclude the potential health risk to its service personnel that can occur when receiving, disassembling, or repairing potentially contaminated products.

**Equipment returned without this form completed and secured to outside of package will be returned to customer unprocessed.**

Equipment must be drained of fluids and residue, securely packaged and shipped prepaid. Concerning the closing of the ports (inlet & outlets of the product), metallic airtight blank flanges should be used if toxic or copper gases have been pumped.

We wish to draw your attention to the following points:

• **The risk may be of the following natures:**

- **Chemical:** Danger to health, risks of explosion, fire, risks for the environment. Please indicate the chemical formula and name of the gases or substances that have been in contact with the equipment (pump or helium detector).

- **Biological:** Pathogenic germs, micro-organisms (bacteria, viruses, etc.) classes 1 to 4 and group E. We are currently unable to deal with contamination of this sort without risk to the safety of our staff. If your equipment has been contaminated in this way, contact us so that we can try to find a solution together.

- **Radioactive:** Contact us in this case.

- **Copper contamination:** Copper based by products formed in sputtering or etching processes are considered as a poison in some semi-conductor processes.

**If following inspection and quotation, customer elects to not proceed with repair, he will be subject to service fee to cover product decontamination, disassembly, cleaning and evaluation costs.**

**Please to fill in the following form, print it and attach it to the product before shipping to the service-centre closest to you.**

**WARNING**

In the event of chemical contamination, please indicate the following gases or substances:

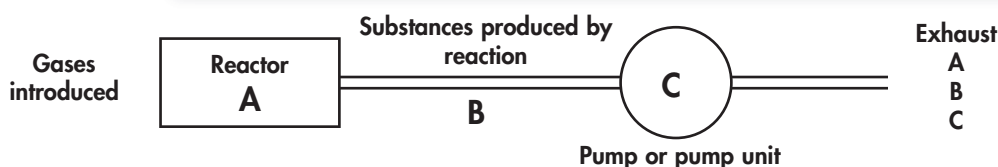

- Gases (or substances) introduced into the reactor and which may be found at the exhaust (A).
- Gases (or substances) resulting from the reaction or process (B).
- Gases (or substances) that may possibly be formed inside the pump (due to a thermodynamic or chemical reaction, condensation, deposition, precipitation, etc.) (C).

• **Precautions need to be taken before transferring contaminated pumps.**

Please contact customer service for recommendations.

# QUESTIONNAIRE DE SECURITE SAFETY QUESTIONNAIRE

Ce questionnaire est téléchargeable sur le site : [www.adixen.com](http://www.adixen.com)

This questionnaire can be downloaded from: [www.adixen.com](http://www.adixen.com)

# G 200

## Procédure de retour des Pompes à Vides et Détecteur de Fuite à Hélium ADIXEN

(Ce formulaire ne peut être rempli et signé que par une personne habilitée)

## Procedure for returning ADIXEN Vacuum Pumps and Helium Leak Detectors

(This questionnaire is only to be filled in and signed by an authorized person)

<b>SOCIETE - COMPANY</b> Nom Société – Name of company: ..... Nom personne – Name of person: ..... (Qui remplit ce formulaire) – (Who has filled in questionnaire) Fonction – Position : ..... N° Tél. – Tel. no : ..... N° Fax – fax no: ..... (Pour renseignements éventuels sur les produits utilisés) – (for any information on products used)		<b>EQUIPEMENT - EQUIPEMENT</b> Description : ..... ..... N° de Série – Serial no : ..... Type de procédé – type of process : ..... (Pour lequel l'équipement est utilisé) – (for which equipment is used) Date de l'expédition – Date of consignment : .....	
<b>INTERVENTION - SERVICE</b> Intervention souhaitée (Révision, réparation,...) – Service required (overhaul, repair, etc.): Type d'anomalie constatée – Type of anomaly observed :			
<b>PROCEDE CUIVRE - COPPER PROCESS</b> Produit utilisé sur un procédé Cuivre – Product used on a Copper process <span style="float: right;">Oui – Yes <span style="margin-left: 100px;">Non – No</span></span>			
<b>ASPECT SECURITE - SAFETY ASPECT</b> L'équipement mentionné ci-dessus a été en contact avec les produits suivants – The above equipment has been in contact with the following substances : (nom et formule chimique) – (name and chemical formula)			
<b>Ces produits présentent un risque de nature These substances present the following risks</b>			
<b>Chimique – Chemical</b> Toxique – Toxic <span style="float: right;">Oui – Yes <span style="margin-left: 20px;">Non – No</span></span> Cancérogène - Carcinogenic <span style="float: right;">Oui – Yes <span style="margin-left: 20px;">Non – No</span></span> Combustible - Combustible <span style="float: right;">Oui – Yes <span style="margin-left: 20px;">Non – No</span></span> Corrosive - Corrosive <span style="float: right;">Oui – Yes <span style="margin-left: 20px;">Non – No</span></span> Explosive - Explosive <span style="float: right;">Oui – Yes <span style="margin-left: 20px;">Non – No</span></span> Biologique – Biological <span style="float: right;">Oui – Yes <span style="margin-left: 20px;">Non – No</span></span> Radioactive – Radioactive <span style="float: right;">Oui – Yes <span style="margin-left: 20px;">Non – No</span></span> Autre – Other (Vous reporter éventuellement à la page précédente) – (See preceding page if necessary)		Explication détaillée – Detailed explanation Si "Oui" risque de nature – If "Yes", what type of risk ..... ..... ..... ..... .....	
<b>SIGNATURE</b> <b>Vous avez répondu "Oui" à une des questions précédentes :</b> Je confirme que seules les substances précisées ont été en contact avec l'équipement sus-mentionné, et que les procédures de préparation, d'emballage, et de transport ont été respectées.  <b>You have replied "yes" to one of the above questions:</b> I confirm that only the substances mentioned have been in contact with the above equipment and that the preparation, packing and transport procedures have been complied with.		Je confirme que le matériel sus-mentionné n'a été en contact avec aucune substance dangereuse, et a été vidé de son huile. (Si applicable)  I confirm that the above equipment has not been in contact with any dangerous substance and has been emptied of oil. (if applicable)	
Réponse "Oui" (fermeture étanche de l'aspiration et du refoulement) Reply «Yes» (seal inlet and outlet ports with blank flanges)		Réponse "Non" (sans risque) Reply "No" (no risk)	
Nom - Name : ..... Fonction - Position : ..... Date : ..... Signature autorisée – Authorised signature :		Nom - Name : ..... Fonction - Position : ..... Date : ..... Signature autorisée – Authorised signature :	
Tampon / Cachet Stamp / Seal		Tampon / Cachet Stamp / Seal	