



OPERATING INSTRUCTIONS

EN

Translation of the original instructions

TPG 201

Measurement unit

PFEIFFER  **VACUUM**

Table of contents

1	About this manual	3
	1.1 Validity	3
	1.2 Conventions	3
2	Safety	4
	2.1 Safety precautions	4
	2.2 Proper use	4
	2.3 Improper use	4
3	Product description	5
	3.1 Product identification	5
	3.2 Function	5
	3.3 Range of application	6
4	Transport and storage	6
5	Installation	6
	5.1 Vacuum connection	6
	5.2 Electrical connection	6
	5.3 USB connection	7
6	Operation	9
	6.1 Switching on	9
	6.2 Storing Data	10
	6.3 Choose unit	11
	6.4 TPG 201 calibration	12
	6.5 PC mode	13
	6.6 Configuring the data exchange	14
	6.7 Pfeiffer Vacuum Protocol for "USB"	16
7	Maintenance	17
	7.1 Cleaning	17
8	Troubleshooting	18
9	Service	19
10	Accessories	19
11	Technical data and dimensions	20
	11.1 Technical data	20
	11.2 Dimensions	20
	11.3 Gas correction factor	21
	Declaration of conformity	22

1 About this manual

1.1 Validity

This operating manual is for customers of Pfeiffer Vacuum. It describes the functioning of the designated product and provides the most important information for safe use of the unit. The description follows applicable EU guidelines. All information provided in this operating manual refers to the current state of the product's development. The documentation remains valid as long as the customer does not make any changes to the product.

Up-to-date operating instructions can also be downloaded from www.pfeiffer-vacuum.com.

1.2 Conventions

Safety instructions

The safety instructions in Pfeiffer Vacuum operating instructions are the result of risk evaluations and hazard analyses and are oriented on international certification standards as specified by UL, CSA, ANSI Z-535, SEMI S1, ISO 3864 and DIN 4844. In this document, the following hazard levels and information are considered:

DANGER
Imminent danger Indicates an imminent hazardous situation that will result in death or serious injury.
WARNING
Possibly imminent danger Indicates an imminent hazardous situation that can result in death or serious injury.
CAUTION
Possibly imminent danger Indicates an imminent hazardous situation that can result in minor or moderate injury.
NOTICE
Command or note Command to perform an action or information about properties, the disregarding of which may result in damage to the product.

Pictographs



Prohibition of an action to avoid any risk of accidents, the disregarding of which may result in serious accidents



Warning of a displayed source of danger in connection with operation of the unit or equipment

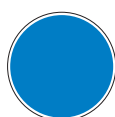

Command to perform an action or task associated with a source of danger, the disregarding of which may result in serious accidents



Important information about the product or this document

Instructions in the text

→ Work instruction: here you have to do something.

Abbreviations

TPG: Measurement and control unit

2 Safety

2.1 Safety precautions



Duty to inform

Each person involved in the installation or operation of the unit must read and observe the safety-related parts of these operating instructions.

→ The operator is obligated to make operating personnel aware of dangers originating from the unit or the entire system.

- Observe the safety and accident prevention regulations.
- Check regularly that all safety precautions are being complied with.
- The unit has been accredited with protection class IP 40. Take necessary measures when installing into ambient conditions, which afford other protection classes.
- Consider possible reactions between the materials and the process media.
- Consider possible reactions of the process media due to the heat generated by the product.
- Do not modify or alter the unit yourself.
- Ensure specified mains voltage.
- Note the shipping instructions, when returning the unit.
- Inform yourself about a possible contamination before starting work.
- Adhere to the relevant regulations and take the necessary precautions, when handling contaminated parts.
- Communicate the safety instructions to other users.

2.2 Proper use

The measurement unit TPG 201 serves exclusively to provide total measurements in the range 1000 ... $5 \cdot 10^{-4}$ hPa. It may only be connected to components specifically provided for this purpose.

2.3 Improper use

Improper is:

- Uses not covered above, and, in particular:
 - connection to pumps and units which is not permitted in their operating instructions;
 - connection to units which contain touchable and voltage carrying parts.

Improper use will cause any rights regarding liability and guarantees to be forfeited.

3 Product description

3.1 Product identification

To correctly identify the product when communicating with Pfeiffer Vacuum, always have the information from the rating plate available.

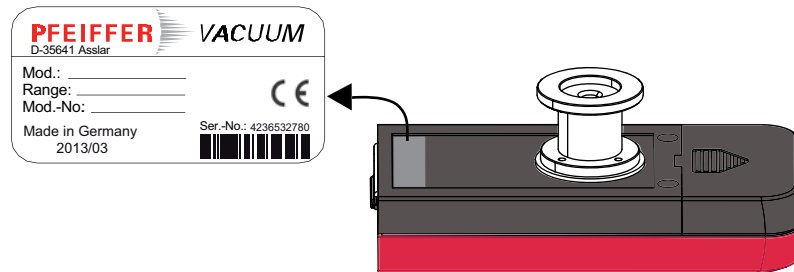

Fig. 1: Product identification on the rating plate (example)

3.2 Function

The Pirani gauge TPG 201 enables absolute pressure measurements in the range of 1000 ... $5 \cdot 10^{-4}$ hPa.

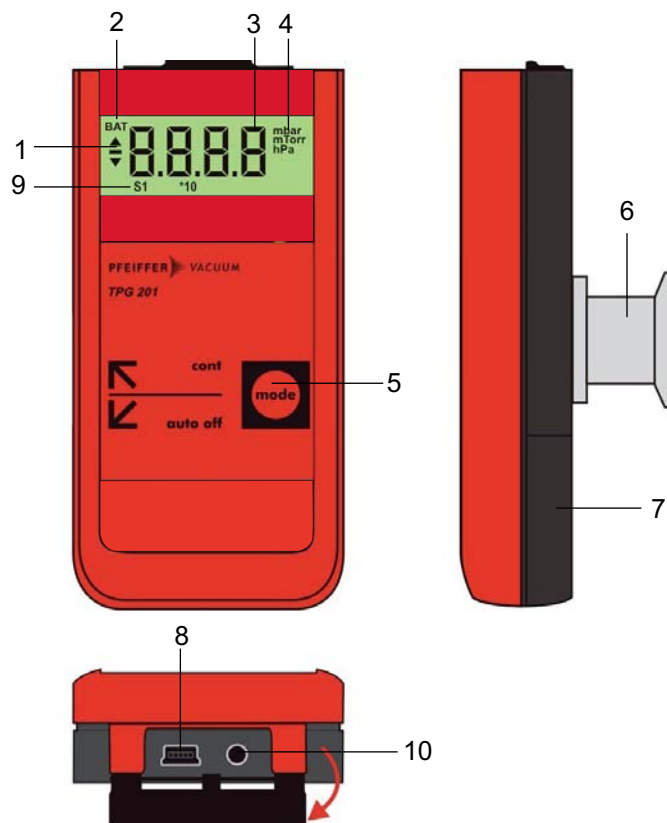
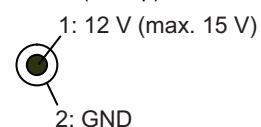

Fig. 2: TPG 201

- 1 Operating mode
- 2 "Change battery" display
- 3 Pressure reading, refresh: 1.0 s
- 4 Measurement unit "mbar, Torr, Pa, hPa"
- 5 Mode key
- 6 Small flange DN 16 ISO-KF
- 7 Battery compartment cover
- 8 USB port
- 9 Active gas correction factor

- 10 Connection for line adapter 12 V=, 50 mA, plug 2.5 mm (+ at tip)



Scope of delivery

The following positions are included in the delivery consignment:

- TPG 201
- Operating instructions
- Block battery (9 V)

3.3 Range of application

The unit TPG 201 must be installed and operated in the following ambient conditions:

Installation location	weather protected (indoor)
Protection class	IP40
Installation altitude	max. 2000 m
Ambient temperature	+5 – +40°C
Relative humidity	max. 85 %
Atmospheric pressure	860 hPa – 1060 hPa

4 Transport and storage

Units without external protection must not come into contact with electrostatically chargeable materials and must not be moved within electrical or magnetic fields.

- In rooms with moist or aggressive atmospheres, the unit must be airproof shrink-wrapped in a plastic bag together with a bag of desiccant.

5 Installation

5.1 Vacuum connection

- Remove the protective cover, which is required during maintenance work.
- Make vacuum connection via small flange DN 16 ISO-KF.



CAUTION	
Excess pressure in the vacuum system > 1000 hPa	Danger of injuries by inadvertent opening of elements under stress due to parts flying around. → Only use stressed elements, which can be opened and closed with appropriate tools (e.g. strap retainer-tension ring).



CAUTION	
Excess pressure in the vacuum system 1500 to 4000 hPa	Damage to health through emission of process media, because elastomer washers cannot withstand the pressure. → Use sealing rings with an outer centering ring.

5.2 Electrical connection

Battery operation

- Before operating the unit a suitable battery or an accumulator must be inserted.
- Pull the battery cover on the back downwards and insert the battery.

→ Close the cover again by pushing it upwards until it snaps into position.



Battery types:

- 9 V Alkali Mangan block battery type 6LR 6; lifetime approx. 40 h
- 9 V Lithium block battery; lifetime approx. 100 h



Poor battery power

Poor battery power is indicated by the „BAT“-prompt in the upper left corner of the display. Operation of the unit is still possible. Once the battery is used up, the unit switches off.

- Change battery or accumulator or recharge accumulator.
- If the unit is not used for a longer time, remove the battery to avoid damages from leaking chemicals.

Operation with power supply

The TPG can be operated alternatively to battery operation with an external power supply (12V). The sockets for the power supply and the USB service interface are located behind a dust protection lid.

→ Open the lid carefully and pull it out slightly.

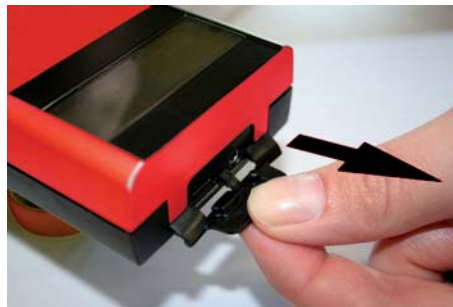

Battery/Accumulator

An inserted battery can remain with attached power supply in the unit. An inserted accumulator is not loaded with attached power supply, but can remain in the unit.

- Use commercially available chargers for loading of accumulators.

5.3 USB connection

The USB port can be connected to a PC, for instance in order to read out the data storage unit, document measurements, or configure the device using Windows¹⁾ DokuStar software.

¹⁾ Windows® is a registered trademark of the Microsoft Cooperation.

Mini socket type B



Pin	Assignment
1	VCC, + 5V
2	Data -
3	Data +
4	GND
5	GND

Install USB driver

The requisite USB driver TPG 201 can be found on the USB drive in the accessories case (PT 350 102 -T) or at www.pfeiffer-vacuum.de/Downloads/Software.

- ➔ Insert the USB drive into the PC's USB port.
- ➔ Start installation:
 - Laufwerk/USB-Treiber TPG/Setup.EXE
- ➔ Follow the rest of the installation instructions.
- ➔ Connect TPG 201 to the PC using a USB cable (from the accessories case).

6 Operation

6.1 Switching on

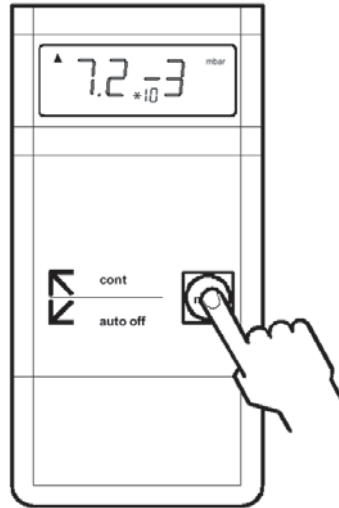

Symbols to the left of the pressure reading:



Press "mode"



"cont," continuous operation



"auto off," device will automatically shut down in 20 s



Logging data:

⇒ Press 1x --> data storage unit is erased and logging starts at the selected logging interval



Data storage is active

Select operating mode

Depending on the last set operating mode, one of the two operating modes appears:

Display mode (rAtE: off)

Device shut down; data storage deactivated (see p. 11, chap. 6.3)



If "auto off" appears, the device will automatically shut down in 20 s.



If "cont" appears, the device is in continuous operation.

Storage mode (rAtE: on)

Device shut down; data storage activated (see p. 11, chap. 6.3)



If "auto off" appears, the device will automatically shut down in 20 s.



If no keys are pressed, the device will switch into auto-off mode in 4 seconds.



The current applied pressure appears in the display. Measurement values are stored according to the configured storage interval.

6.2 Storing Data

Deleting data

Device shut down; data storage activated (see p. 11, chap. 6.3)

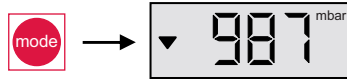

If "auto off" appears, the device will automatically shut down in 20 s.

If a key is pressed, the contents of the data storage unit will be erased.



⇒ If no keys are pressed, the device will switch into auto-off mode in 4 seconds

Store data

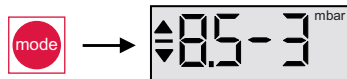

The current applied pressure appears in the display. Measurement values are stored according to the configured storage interval.

The device will stay on until it is manually shut down.

Quit storage mode

Storage stops as soon as the storage unit is full (max. of 2,000 measurement values) or the device is shut down.

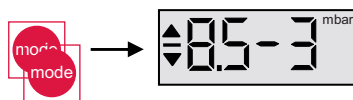

⇒ Double keystroke: device switches into auto-off mode and will shut down automatically in approximately 10 s.

Setting the storage rate

In order to configure the storage interval, the device's configuration mode must be activated.

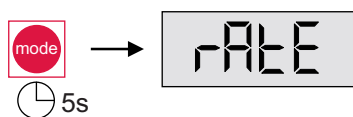

Condition: Measurement device is shut down!

⇒ Hold down the mode key of the shut-down device for approximately 5 seconds until the "rATE" display appears. 5 s later, the current storage interval configuration will appear in the display. This can be changed using the mode key.

If no key is pressed within 10 s, the device will switch into "auto-off" mode and the currently configured storage interval will remain unchanged.



If "off" is displayed, the internal data storage is switched off.



Measurement values are stored every 1.0 seconds. Other storage intervals: 2s, 10s, 1 min, 10 min

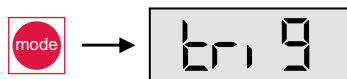

If "trig" appears, new measurement values will only be stored if the current value differs from the last stored value by at least 2 digits (e.g.: 2.3 ... 2.5). This reduces the data volume and optimally utilizes the storage unit.

6.3 Choose unit

In order to configure the measurement unit, the device must be switched into configuration mode. Hold down the mode key of the shut-down device until the "rAtE" display appears.

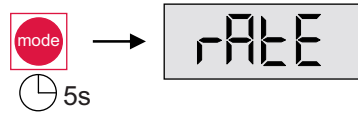

Condition: Measurement device is shut down!

⇒ Hold down the mode key of the shut-down device for approximately 5 seconds until the "rAtE" display appears.

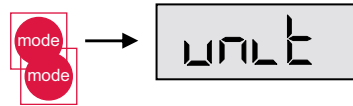

⇒ Press the mode key repeatedly until the "unit" display appears.



5 s later, the current measurement unit configuration will appear in the display:

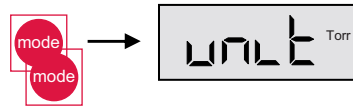

⇒ Within 10 s, select "mbar," "Torr," or "hPa" using the mode key.

6.4 TPG 201 calibration

Atmosphere (CALH)

The device is calibrated ex works. Use under other climate conditions, extreme temperature fluctuations, weathering, or dirt may necessitate readjustment. Conduct zero-point adjustment at the same ambient temperature at which the device is typically operated. Also hold down the mode key of the shut-down device until the "rAtE" display appears.

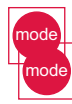

⇒ Press the mode key repeatedly until the "CAL" display appears.



"CAL.H" will appear in the display in 5s.

⇒ Confirm the "CAL.H" display by pressing the mode key.

If no keys are pressed adjustment is carried out in **5s**.



"CALI" will appear in the display during the calibration procedure (approx. 20s). No calibration is performed, if during calibration the error message „Err“ appears.



Adjustment on atmospheric pressure

The pressure measured with the unit must be above 40 hPa for adjusting. Otherwise adjustment is denied and the error message "Err" displayed.

→ Pay attention to the necessary pressure, when adjusting.

High vacuum (CAL.L)



Adjustment on zero pressure

For adjustment on zero pressure the actual pressure inside the sensor has to be less than 1×10^{-4} hPa. The pressure reading must be less than 4×10^{-2} hPa. Otherwise adjustment is denied and the error message "Err" displayed.

→ Pay attention to the necessary pressure, when adjusting.



Condition: Measurement device is shut down!

⇒ Hold down the mode key of the shut-down device for approximately 5 seconds until the "rAtE" display appears.



⇒ Press the mode key repeatedly until the "CAL" display appears.



"CAL.H" will appear in the display in 5s.



"CAL.L" will appear in the display in another 5s.

⇒ Apply the necessary pressure $< 1 \cdot 10^{-4}$ hPa.

⇒ Confirm the "CAL.L" display by pressing the mode key.

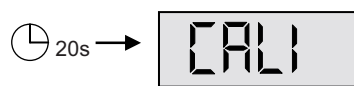

"CALI" will appear in the display during the calibration procedure (approx. 20s).



If „ur" appears during the calibration procedure, calibration has been successful.



„Err" : error message. Calibration has not taken place.

6.5 PC mode

The TPG 201 can be connected to the PC via a USB port in order to transmit the measurement data. The DokuStar software (accessory) supports recording current pressure values (online measurement) as well as reading out the measurement value storage unit. The measurement values are represented as a diagram and can be exported as a text file for further analysis.

All the device parameters such as the storage interval, display unit, or the gas type correction factor can also be easily configured using the software.



⇒ Create a cable connection using an open USB port on the PC.

The device will switch into PC mode and is ready for bidirectional data transmission. Communication takes place in accordance with PV protocol (see p. 16, chap. 6.7).



PC mode!

If the TPG 201 switches into PC mode, the current measurement value display as well as any data logging that may be running will close.

→ After the USB cable is disconnected, the TPG 201 will switch into auto-off mode.

→ Starting data storage after disconnecting from the PC in accordance with (see p. 10, chap. 6.2)

6.6 Configuring the data exchange

Communication is carried out via the USB interface using the Pfeiffer Vacuum protocol:

- 9600 baud
- 8 data bits
- 1 stop bit
- no parity

Parameter overview

#	Name	Data type	Application
303	Current error code	4 - string	Read-only
312	Software version	4 - string	Read-only
349	Device name	4 - string	Read-only
643	Physical unit	7 - u_short_int	Readable, writable
740	Pressure value in [hPa]	10 - u_expo_new	Readable
742	(Pirani) correction factor	2 - u_real	Readable, writable
770	Data logging interval	1 - pos. integer number	Readable, writable
771	Data logging record	11 - symbol chain	Read-only

Parameters are displayed in square brackets as a three-digit number in bold font. The designation may also be stated if necessary.

Example: **[P:312] Software version**

Applied data types

Data type	Description	Size 11 - 10	Example
0 - boolean_old	Boolean value (false / true)	06	000000 / 111111
1 - u_integer	Positive integer number	06	000000 to 999999
2 - u_real	Positive fixed point number	06	001571 equal to 15.71
4 - string	String	06	TC_400
6 - boolean_new	Boolean value (false / true)	01	0 / 1
7 - u_short_int	Positive integer number	03	000 to 999
10 - u_expo_new	Positive exponential number	06	100023
11 - string	String	16	BrezelBier&Wurst

Reading the actual pressure value [P:740]

Pressure value as the value to be queried are transmitted by means of a string in the format "**aaaabb**", whereby "**aaaa**" is the mantissa and "**bb**" the exponent with offset 20 of an exponential number. "**aaaa**" is therefore in the range "1000" (for 1.000) to "9999" (for 9.999). The individual characters of the string are the numbers "0" (ASCII 48) to "9" (ASCII 57).

Example: "100023" represents $1.000 \times 10^{+3}$ mbar, "750015" represents 7.500×10^{-5} mbar.

Writing the unit [P:643]

The unit for representing the **pressure value in the display** can be selected manually using the mode key or via the interface. This does not impact the unit of the transmitted pressure values: these are always given in hPa.

Reading error codes [P:303]

Parameter 303 transfers the actual error code of the unit. The following error codes can occur:

Value	CPT 200	PPT 200	RPT 200	HPT 200	MPT 200	Meaning
000000	X	X	X	X	X	No error
Wrm001				X		Filament 1 defective in auto-mode
Err001	X	X	X	X	X	Defective gauge
Err002	X	X	X	X	X	Defective memory
Err003				X		Filament 1 defective
Err004				X		Filament 2 defective

Value	CPT 200	PPT 200	RPT 200	HPT 200	MPT 200	Meaning
Err005				X		Both filaments defective

Reading the component names [P:349]

Parameter 349 contains a token of the component name:

- TPG201

Reading the software version [P:312]

The software version can be read from the connected device using parameter 312:

- Example: 010102

Reading/writing the gas correction factor [P:742]

The correction factor can be set to values in the range 0.2–8.0 :

- Example: 1,00 (written as 000100)

Read/write the storage interval [P:770]

The following storage intervals can be selected using parameter [P:770]:

- OFF, 1s, 2s, 10s, 60s, 600s, trig interval in [s]

Additionally, storage intervals ranging from 0 (off) to 9999 can be configured via the USB port using the PV protocol.

Reading data from memory [P:771]

The stored values (max. of 2,000) can be read from the TPG 201 using parameter [P:771]:

- Data format: 00mmmeettttttt
 - mmmmee: Measurement value in data format u_expo_new, data = m.mmm x 10 ^ (ee - 20)
 - ttttttt: Time of the logging in s since the beginning
 - Logging not/no longer available: 9999999999999999

Caution: In order to increase the energy efficiency of the operating system, delayed response times of up to 0.5 seconds are possible.

6.7 Pfeiffer Vacuum Protocol for "USB"

Telegram frame

The telegram frame of the Pfeiffer Vacuum protocol contains only ASCII code characters [32; 127], the exception being the end character of the message C_R . Basically, a master \square (e.g. a PC) sends a telegram, which is answered by a slave \circ (e.g. electronic drive unit or gauge).

a2	a1	a0	*	0	n2	n1	n0	l1	l0	dn	...	d0	c2	c1	c0	C_R
a2 - a0		Unit address for slave \circ – Individual address of the unit ["001"]														
*		Action														
n2 - n0		Pfeiffer Vacuum parameter numbers														
l1 - l0		Data length dn ... d0														
dn - d0		Data in data type concerned														
c2 - c0		Checksum (sum of ASCII values of cells a2 to d0) modulo 256														
C_R		Carriage return (ASCII 13)														

Telegrams

Data request $\square \Rightarrow \circ ?$

a2	a1	a0	0	0	n2	n1	n0	0	2	=	?	c2	c1	c0	C_R
----	----	----	---	---	----	----	----	---	---	---	---	----	----	----	-------

Control command $\square \Rightarrow \circ !$

a2	a1	a0	1	0	n2	n1	n0	l1	l0	dn	...	d0	c2	c1	c0	C_R
----	----	----	---	---	----	----	----	----	----	----	-----	----	----	----	----	-------

Data response / control command understood $\circ \Rightarrow \square \checkmark$

a2	a1	a0	1	0	n2	n1	n0	l1	l0	dn	...	d0	c2	c1	c0	C_R
----	----	----	---	---	----	----	----	----	----	----	-----	----	----	----	----	-------

Error message $\circ \Rightarrow \square *$

a2	a1	a0	1	0	n2	n1	n0	0	6	N	O	_	D	E	F	c2	c1	c0	C_R
										_	R	A	N	G	E				
										_	L	O	G	I	C				

NO_DEF	The parameter n2 - n0 does not exist
_RANGE	Data dn - d0 are outside the permitted range
_LOGIC	Logic access violation

Telegram examples

Read actual pressure value (data query)

(Parameter [P:740], Slave device address: "001")

$\square \Rightarrow \circ ?$	0	0	1	0	0	7	4	0	0	2	=	?	1	0	6	C_R			
ASCII	48	48	49	48	48	55	52	48	48	50	61	63	49	48	54	13			
$\circ \Rightarrow \square \checkmark$	0	0	1	1	0	7	4	0	0	6	1	0	0	2	3	0	2	5	C_R
ASCII	48	48	49	49	48	55	52	48	48	54	49	48	48	50	51	48	50	53	13

7 Maintenance

7.1 Cleaning



WARNING

Explosion hazard

The use of volatile or combustible cleaning agents in vacuum systems can lead to explosive vapour-air mixtures.

→ After cleaning ventilate and let dry completely.



CAUTION

Use suitable cleaning agents!

Cleaning agents can be detrimental to health and the environment!

→ Adhere to the relevant regulations when using cleaning agents.

→ Never use propanone (e.g. acetone) or halogenated hydrocarbons for cleaning!

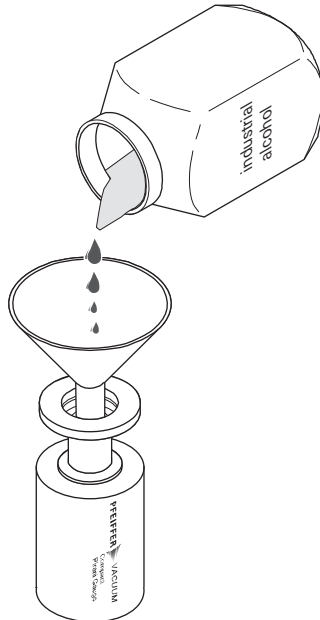

Fig. 3: Clean gauge

- Detach the gauge from the vacuum apparatus.
- Fill carefully with industrial alcohol; allow to soak for 5 minutes.
- Pour out the alcohol and dispose of according to the local regulations.
- Allow the measurement chamber to dry sufficiently (at least 10 minutes).
- Connect the gauge to the vacuum chamber.
- Evacuate the gauge.
- Adjust the gauge.

8 Troubleshooting

Problem	Possible cause	Correction
Measurement value deviation too high	Aging, contamination, extreme temperatures, wrong adjustment	Readjustment
Display "or"	Measurement range exceeded	(Pressure > 1000 hPa)
Display "ur"	Measurement range fallen below	(Pressure < 5×10^{-4} hPa)
Error message "Err"	Adjustment performed with wrong pressure	Displayed pressure must be for atmospheric pressure > 800 hPa, for zero compensation < 4×10^{-2} hPa
	Measurement value deviation exceeds the adjustment range	Send in the device
Error message "Err1"	Sensor defective	Send in the device

9 Service

Do make use of the Pfeiffer Vacuum service facilities. In the event that repairs are necessary a number of options are available to ensure any system down time is kept to minimum:

- Repair in the nearby Service center
- Send unit and have it replaced with a new unit

Sending of units (Service Request)

For a quick and smooth handling of the service process, Pfeiffer Vacuum recommends the following steps:

- ➔ Download the forms "Service Request" and "Declaration on Contamination".¹⁾
- ➔ Fill out the "Service Request" form and send it by fax or e-mail to your local Pfeiffer Vacuum service contact.
- ➔ Include the confirmation on the "Service Request" from Pfeiffer Vacuum with your shipment.
- ➔ Fill out the "Declaration of Contamination" and include it in the shipment. This document is mandatory to protect our service engineers.
 - Fill out and send one declaration for each device.
- ➔ If possible, send unit in the original packaging.

In the absence or incompleteness of the "Declaration on Contamination" and/or the use of unsuitable transport packaging, Pfeiffer Vacuum reserves the right to make a decontamination and/or to send the product back at the shipper's expense.

Service orders

All service orders are carried out exclusively according to our repair conditions for vacuum units and components. Detailed information, addresses and forms at:

<http://www.pfeiffer-vacuum.com/service/repair-services/container>.

10 Accessories

Designation	TPG 201
Accessories kit with AC adapter, battery, USB cable, DokuStar software	PT 350 102 -T

¹⁾ Forms under www.pfeiffer-vacuum.com

11 Technical data and dimensions

11.1 Technical data

Parameter	TPG 201
Protection category	IP 40
Nominal diameter	DN 16 ISO-KF
Battery type	9 V AlMn E bloc, 6 LR6 ; 9 V Lithium E bloc
Seal	Metal
Pressure max.	4000 hPa
Feature	Pirani sensor
Accuracy	10-100 hPa: 30 %; 10 ⁻² - 10 hPa: 10 %; < 10 ⁻³ : ≤ factor 2 of reading
Weight	0.195 kg
Materials in contact with media	Nickel, stainless steel, tungsten, glass-feedthroughs
Measurement range max.	1000 hPa
Measurement range min.	5 · 10 ⁻⁴ hPa
Method of measurement	Pirani
Temperature: Operating	5-40 °C

11.2 Dimensions

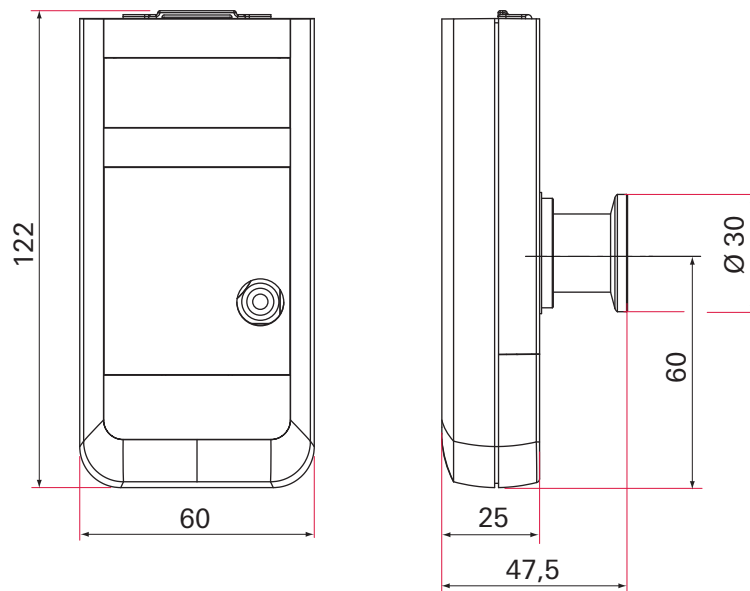

11.3 Gas correction factor

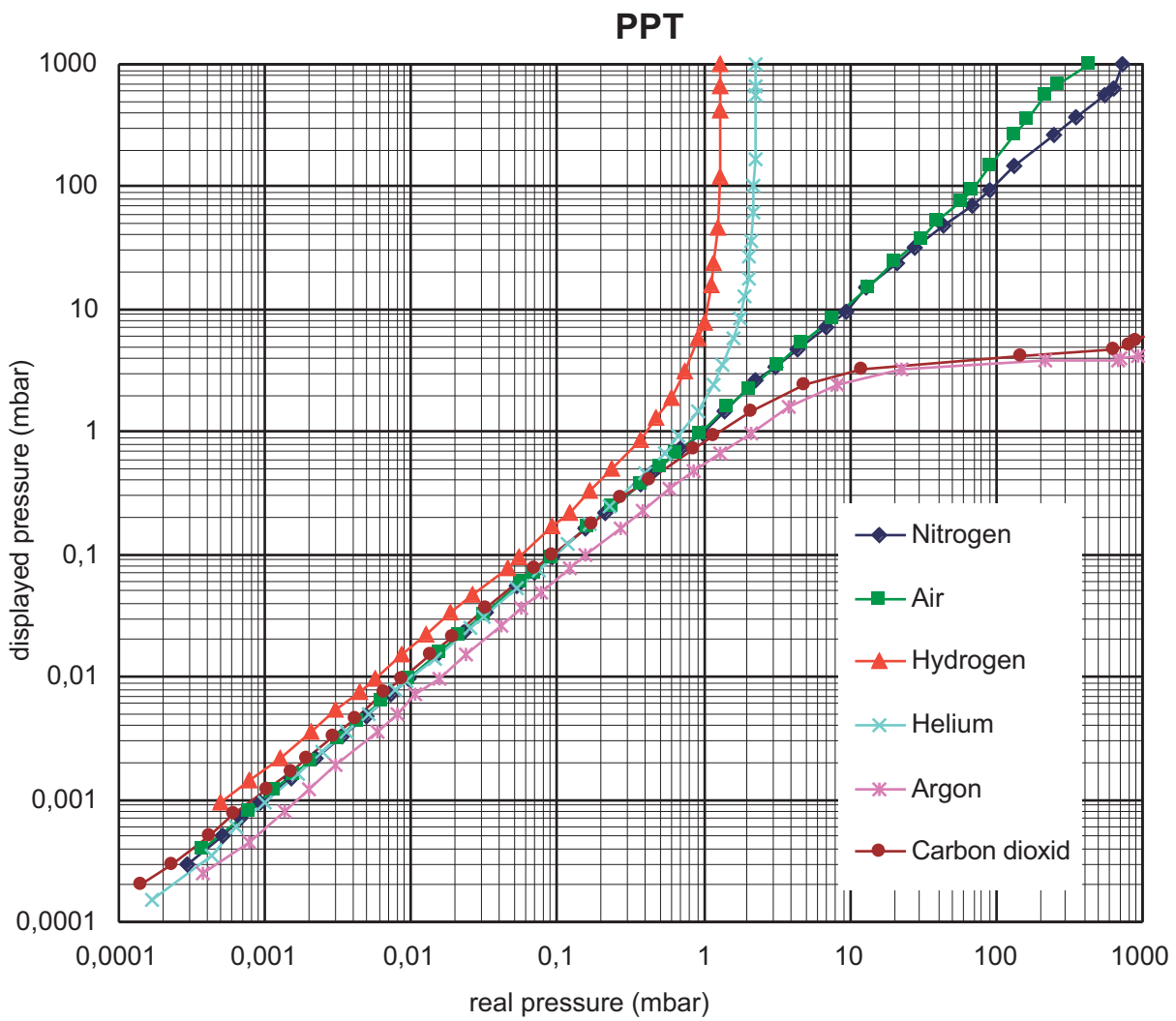

Fig. 4: Dependent on gas type TPG 201 (Pirani)

Pirani correction factor (for pressures $<1 \cdot 10^{-1}$ hPa)	
N ₂	1.00
Air	1.00
H ₂	0.58
He	1.02
Ar	1.59
CO ₂	0.89



Declaration of conformity

We hereby declare that the product cited below satisfies all relevant provisions according to the following **EC directives**:

- **Electromagnetic Compatibility 2014/30/EU**
- **Restriction of the use of certain Hazardous Substances 2011/65/EU**

DigiLine
TPG 201

Harmonised standards and national standards and specifications which have been applied:

EN 61326-1: 2013 Group 1 / Class B
EN 50581: 2012

Signature:

Pfeiffer Vacuum GmbH
Berliner Straße 43
35614 Asslar
Germany

(Dr. Ulrich von Hülsen)
Managing Director

Asslar, 2017-11-13

VACUUM SOLUTIONS FROM A SINGLE SOURCE

Pfeiffer Vacuum stands for innovative and custom vacuum solutions worldwide, technological perfection, competent advice and reliable service.

COMPLETE RANGE OF PRODUCTS

From a single component to complex systems:

We are the only supplier of vacuum technology that provides a complete product portfolio.

COMPETENCE IN THEORY AND PRACTICE

Benefit from our know-how and our portfolio of training opportunities!

We support you with your plant layout and provide first-class on-site service worldwide.

Are you looking for a
perfect vacuum solution?
Please contact us:

Pfeiffer Vacuum GmbH
Headquarters • Germany
T +49 6441 802-0
info@pfeiffer-vacuum.de

www.pfeiffer-vacuum.com

PFEIFFER  **VACUUM**