



*Vacuum Products Division*



Operating Instructions

# ***Vacuum Gauge Display***

***AGD-100***

Manual No. TQNb16e1  
Revision 1  
March 2012

# ***Vacuum Gauge Display***

**AGD-100**

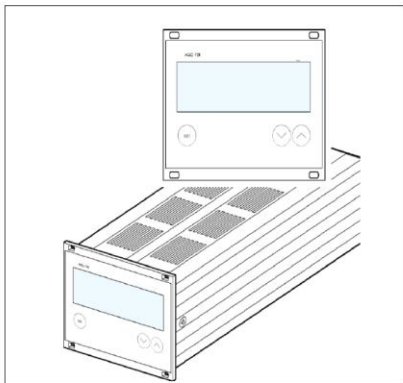

**Preliminary**

Declaration of Conformity  
Konformitätserklärung  
Déclaration de Conformité  
Declaración de Conformidad  
Verklaring de Overeenstemming  
Dichiarazione di Conformità  
一致性声明

適合宣言  
적합성 선언

We  
Wir  
Nous  
Nosotros  
Wij  
Noi  
我们  
私たち  
우리는



Agilent Technologies



Agilent Technologies  
121 Hartwell Ave.  
Lexington, MA 02421-3133 USA

declare under our sole responsibility that the product,  
erklären, in alleniniger Verantwortung, daß dieses Produkt,  
déclarons sous notre seule responsabilité que le produit,  
declaramos, bajo nuestra sola responsabilidad, que el producto,  
verklaren onder onze verantwoordelijkheid, dat het product,  
dichiariamo sotto nostra unica responsabilità, che il prodotto,  
基于独立承担责任的原则, 特声明  
は、当社単独の責任の下、この宣言が該当する製品  
당사의 책임하에

#### Vacuum Gauge Display AGD-100

to which this declaration relates is in conformity with the following standard(s) or other normative documents.  
auf das sich diese Erklärung bezieht, mit der/den folgenden Norm(en) oder Richtlinie(n) übereinstimmt.  
auquel se réfère cette déclaration est conforme à la (aux) norme(s) ou au(x) document(s) normatif(s).  
al que se refiere esta declaración es conforme a la(s) norma(s) u otro(s) documento(s) normativo(s).  
waarnaar deze verklaring verwijst, aan de volende norm(en) of richtlijn(en) beantwoordt.  
a cui se riferisce questa dichiarazione è conforme alla/e seguente/i norma/o documento/i normativo/i.  
符合以下标准或其它标准文档要求。  
が、以下の規格またはその他の基準書類に適合することを宣言します。  
이 선언과 관련한 제품이 다음의 표준과 기타 표준 문서를 준수한다는 것을 선언합니다.

- EN 61010 1:2001 (Safety requirements for electrical equipment for measurement, control and laboratory use)
- EN 61326 1:2006 (Electrical equipment for measurement, control and laboratory use; general EMC requirements)
- EN 61326 2 2:2006 (Electrical equipment for measurement, control and laboratory use; particular EMC requirements)

John Ehmann  
Operations Manger  
Agilent, Inc.  
Vacuum products Division  
Lexington, MA USA

# Contents

Product Identification	7
Validity	7
Intended Use	8
Scope of Delivery	8
<b>1 Safety</b>	<b>9</b>
1.1 Symbols Used	9
1.2 Personnel Qualifications	10
1.3 General Safety Instructions	10
1.4 Liability and Warranty	11
<b>2 Technical Data</b>	<b>12</b>
<b>3 Installation</b>	<b>15</b>
3.1 Installation in a Control Panel	15
3.2 Mains Power Connector	17
3.3 SENSOR Connector	18
3.4 OUTPUT Connector	19
<b>4 Operation</b>	<b>21</b>
4.1 Front Panel	21
4.2 Turning the AGD-100 On and Off	22
4.3 Operating Modes	23
4.4 Measurement Mode	24
4.5 Parameter Mode	25
4.5.1 Gauge Identification	27
4.5.2 Pressure unit	27
4.5.3 Switching threshold	28
<b>5 Maintenance, Repair</b>	<b>29</b>
<b>6 Troubleshooting</b>	<b>30</b>
<b>7 Repair</b>	<b>32</b>
<b>8 Storage</b>	<b>32</b>
<b>9 Disposal</b>	<b>33</b>

**Appendix**



A: Default Parameters

B: Literature

**34**

34

35

For cross-references within this document, the symbol (→  XY) is used, for cross-references to further documents, listed under "Further Information", the symbol (→  [Z]).

Preliminary

## Vacuum Gauge Display AGD-100

### Product Identification

In all communications with Agilent, please specify the information on the product nameplate. For convenient reference copy that information into the space provided below:

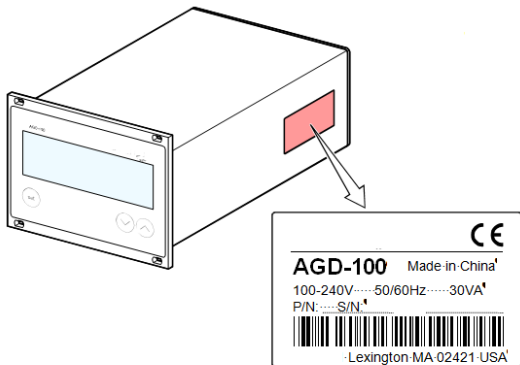

### Validity

This document applies to products with part number AGD100.  
The part number (PN) can be taken from the product nameplate.

This document is based on firmware number F-2.xx.

If your unit does not work as described in this document, please check that it is equipped with the above firmware version (→ 22).

We reserve the right to make technical changes without prior notice.

All dimensions are indicated in mm.

## Vacuum Gauge Display AGD-100

### Intended Use

The Vacuum Gauge Display AGD-100 is used together with an Agilent

- Pirani Standard Gauge of the PVG-5xx series
- Pirani Capacitance Diaphragm Gauge of the PCG-75x series
- Inverted Magnetron Pirani Gauge of the FRG-70x series

for total pressure measurement. All products must be operated in accordance with their respective Instruction Manuals.

### Scope of Delivery

- 1x Vacuum Gauge Display
- 1x Power cord
- 1x Instruction Manual



## 1 Safety

### 1.1 Symbols Used



**DANGER**

Information on preventing any kind of physical injury.



**WARNING**

Information on preventing extensive equipment and environmental damage.



**Caution**

Information on correct handling or use. Disregard can lead to malfunctions or minor equipment damage.

#### Further symbols



The lamp/display is lit.



The lamp/display is dark.



Press the key (example: 'set' key).



Do not press any key

## 1.2 Personnel Qualifications



### Skilled personnel

All work described in this document may only be carried out by persons who have suitable technical training and the necessary experience or who have been instructed by the end-user of the product.

## 1.3 General Safety Instructions

Adhere to the applicable regulations and take the necessary precautions for all work you are going to do and consider the safety instructions in this document.



### DANGER



DANGER: mains voltage

Contact with live parts is extremely hazardous when any liquids penetrate into the unit.

Make sure no liquids penetrate into the equipment.

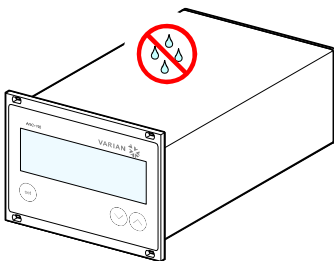

## Vacuum Gauge Display AGD-100

### Disconnecting device

The disconnecting device must be readily identifiable and easily reached by the user.

To disconnect the controller from mains, you must unplug the mains cable.

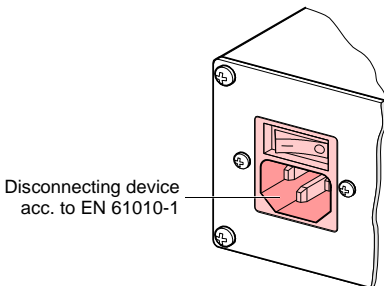

Communicate the safety instructions to all other users.

### 1.4 Liability and Warranty

Agilent assumes no liability and the warranty becomes null and void if the end-user or third parties

- disregard the information in this document
- use the product in a non-conforming manner
- make any kind of interventions (modifications, alterations etc.) on the product
- use the product with accessories not listed in the product documentation.

## 2 Technical Data

### Mains specifications

Voltage	100 ... 240 VAC
Frequency	50 ... 60 Hz
Power consumption	≤30 VA
Overvoltage category	II
Protection class	1
Connection	European appliance connector IEC 320 C14

### Ambiance

Temperature	
Storage	-20 ... +60 °C
Operation	+ 5 ... +50 °C
Relative humidity	≤80% up to +31 °C, decreasing to 50% at +40 °C
Use	indoors only max. altitude 2000 m NN
Pollution degree	II
Degree of protection	IP20 (EN 60529)

### Compatible gauges

Number	1
Compatible types	
Pirani	PVG (PVG-500, PVG-502, PVG-550, PVG-552)
Pirani/Capacitive	PCG (PCG-750, PCG-752)
Cold cathode/Pirani	FRG (FRG-700, FRG-702)

### Gauge connection

SENSOR connector	RJ45 (FCC68), female (pin assignment → 19)
------------------	---

### Operation

Front panel	via 3 keys
-------------	------------

## Vacuum Gauge Display AGD-100

### Measurement values

Measurement range (air, O <sub>2</sub> , CO, N <sub>2</sub> )	5×10 <sup>-4</sup> ... 1000 mbar (+1.9 ... +10.0 VDC) (→  [1],[3],[4])
Measurement error	
Gain error	≤0.02% FSr
Offset error	≤0.05% FSr
Measurement rate	30 / s
Display rate	50 / s
Filter time constant	150 ms (f <sub>g</sub> = 1 Hz)
Pressure units	mbar, Pa, Torr

### Gauge supply

Voltage	+24 VDC ±5%
Current	750 mA
Power consumption	18 W
Fuse protection	900 mA with PTC element, self-resetting after turning the AGD-100 off or disconnecting the gauge

### Switching function

Number	1
Reaction delay	≤10 ms if switching threshold close to measurement value (for larger differences consider filter time constant).
Adjustment range	
PVG	1×10 <sup>-3</sup> ... 500 mbar
PCG	default 1×10 <sup>-3</sup> mbar
FRG	1×10 <sup>-4</sup> ... 500 mbar
default	1×10 <sup>-4</sup> mbar
FRG	1×10 <sup>-8</sup> ... 500 mbar
default	1×10 <sup>-8</sup> mbar
Hysteresis	≥10% of measurement value

## Vacuum Gauge Display AGD-100

### Switching function relay

Contact type	floating changeover contact
Load max.	60 VDC, 1 A (ohmic) 50 VAC, 5 A (ohmic)
Service life	
Mechanic	$10^8$ cycles
Electric	$10^5$ cycles (at maximum load)
Contact positions	→ 20
OUTPUT connector	9-pin D-Sub, male (pin assignment → 20)

### Analog output

Number	1
Voltage range	0 ... +10 V
Internal resistance	660 $\Omega$
Measurement signal vs. pressure	logarithmic, 1.286 V/decade
OUTPUT connector	9-pin D-Sub, male (pin assignment → 20)

### Dimensions [mm]

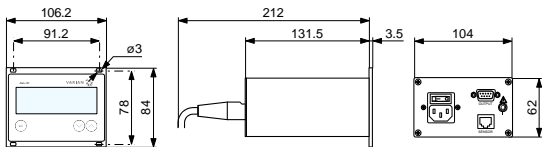

Use	For incorporation into a control panel
Weight	0.85 kg

## 3 Installation



**DANGER**

**DANGER:** damaged product

Putting a damaged product into operation can be extremely hazardous.

In case of visible damages, make sure the product is not put into operation.

### 3.1 Installation in a Control Panel

The AGD-100 is suited for incorporation into a control panel.



**DANGER**

**DANGER:** protection class of the control panel

If the product is installed in a rack, it is likely to lower the protection class of the rack (protection against foreign bodies and water) e.g. according to the EN 60204-1 regulations for switching cabinets.

Take appropriate measures for the control panel to meet the specifications of the protection class.

## Vacuum Gauge Display AGD-100

For mounting the AGD-100 into a control panel, the following cut-out is required:

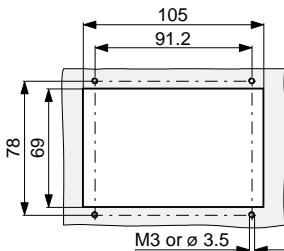

The admissible maximum ambient temperature ( $\rightarrow$  12) must not be exceeded neither the air circulation obstructed.

For reducing the mechanical strain on the front panel, preferably support the unit.

Slide the AGD-100 into the cut-out of the control panel ...

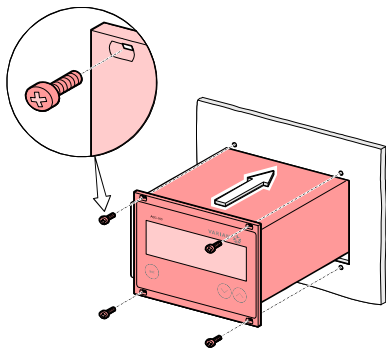

... and secure it with four M3 or equivalent screws.



## 3.2 Mains Power Connector



**DANGER**



**DANGER:** line voltage

Incorrectly grounded products can be extremely hazardous in the event of a fault.

Use only a 3-conductor power cable ( $3 \times 1.5 \text{ mm}^2$ ) with protective ground. The power connector may only be plugged into a socket with a protective ground. The protection must not be nullified by an extension cable without protective ground.

The unit is supplied with a 2 m power cord. If the mains cable is not compatible with your system, use your own, suitable cable with protective ground.



The socket must be fuse-protected with  $10 \text{ A}_{\text{max}}$

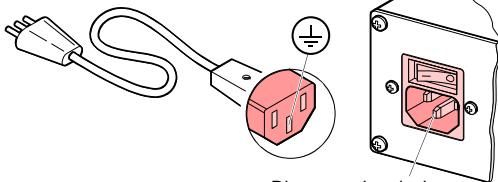

Disconnecting device  
acc. to EN 61010-1

If the unit is installed in a switch cabinet, the mains voltage should be supplied and turned on via a central power distributor.

## Vacuum Gauge Display AGD-100

### Grounding

On the rear of the unit, there is a screw which can be used to connect the unit to ground, e.g. using the grounding of the pumping station.

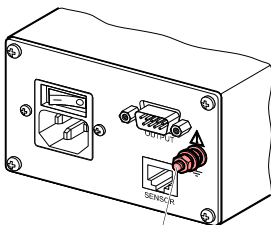

Ground screw 

### 3.3 SENSOR Connector

Connect the gauge to the SENSOR connector on the rear of the unit. Use a screened 1:1 cable (electromagnetic compatibility). Make sure the gauge is compatible (→  12).

 **DANGER**



**DANGER:** protective low voltage

According to EN 61010, voltages exceeding 30 VAC or 60 VDC are hazardous.

Only connect a protective low voltage (SELV).

## Vacuum Gauge Display AGD-100

### Pin assignment SENSOR

Pin assignment of the 8-pin RJ45 appliance connector:

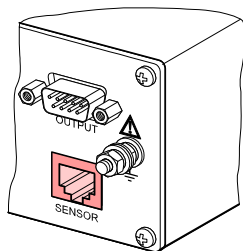

Pin	Signal
4	Identification
1	Supply +24 VDC
2	Supply common GND
3	Signal input (Measurement signal+)
5	Signal common (Measurement signal-)
6	not connected
7	not connected
8	not connected

### 3.4 OUTPUT Connector

This connector allows to read the measurement signal and to evaluate state of the floating switching function.



Connect the peripheral components to the OUTPUT connector on the rear of the unit. Use a screened cable (electromagnetic compatibility).

## Vacuum Gauge Display AGD-100



**DANGER**



**DANGER:** protective low voltage



According to EN 61010, voltages exceeding 30 VAC or 60 VDC are hazardous.

Only connect a protective low voltage (SELV).

### Pin assignment, Contact positions OUTPUT

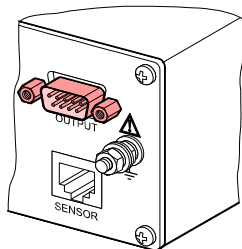
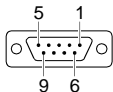
Pin assignment of the female 9-pin D-Sub appliance connector:



Pin	Signal
1	Analog output 0 ... +10 VDC
2	Chassis = GND
3	 Pressure below threshold
4	
5	 Pressure above threshold or power supply turned off
9	not connected
8	not connected
6	not connected
7	not connected

## 4 Operation

### 4.1 Front Panel

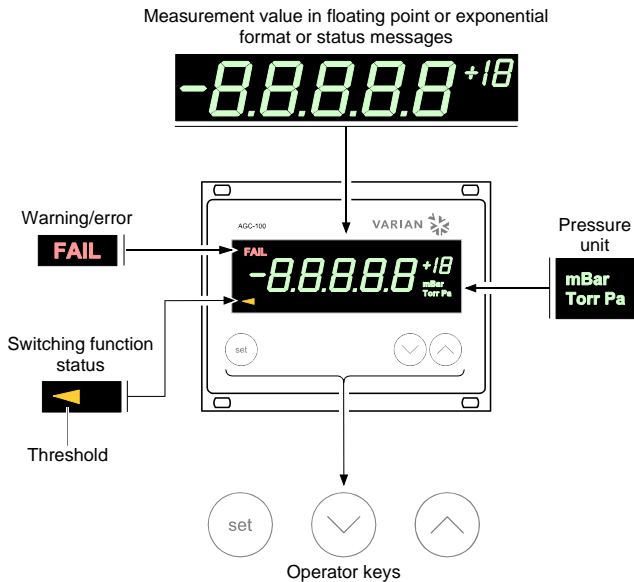

### 4.2 Turning the AGD-100 On and Off

Make sure the AGD-100 is correctly installed and the specifications in the Technical Data are met.

#### Turning the AGD-100 on

The power switch is on the rear of the unit.

Turn the AGD-100 on with the power switch (or centrally, via a switched power distributor, if the unit is incorporated in a rack).

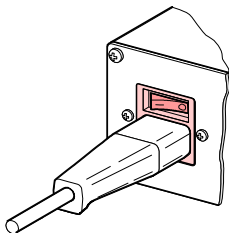

After power on, the AGD-100 ...

- automatically performs a self-test
- displays the firmware version F-2.xx for 3 s
- displays the gauge type for 3 s
- activates the parameters that were in effect before the last power off
- switches to the Measurement mode

#### Turning the AGD-100 off



Turn the AGD-100 off with the power switch (or centrally, via a switched power distributor, if the unit is incorporated in a rack).



Wait at least 10 s before turning the AGD-100 on again in order for it to correctly initialize itself.

### 4.3 Operating Modes

The AGD-100 works in the following operating modes:

- Measurement mode  
for displaying measurement values or status messages  
(→  24)
- Parameter mode  
for entering or displaying parameters (→  25)

## Vacuum Gauge Display AGD-100

### 4.4 Measurement Mode

The Measurement mode is the standard operating mode of the AGD-100. Measurement values and status messages (→ 30) are displayed in this mode.

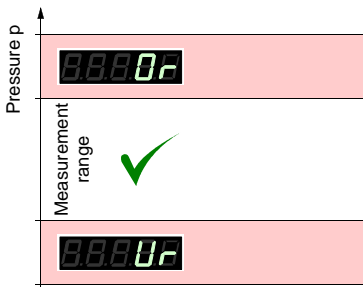
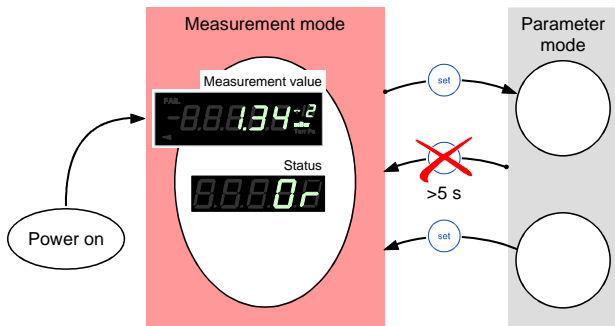



## 4.5 Parameter Mode

The Parameter mode is used for displaying, editing and entering parameter values.

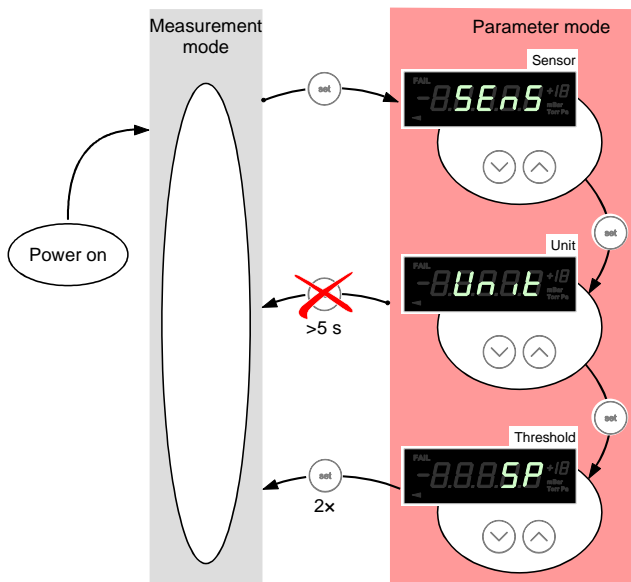

## Vacuum Gauge Display AGD-100

### Selecting a parameter



⇒ The name of the parameter

e.g.:   
Sensor

is displayed as long as the key is pressed or at least for 1 s.

Afterwards, the currently valid parameter value is displayed.

### Editing the parameter value



⇒ Press key <1 s:  
The value is increased / decreased by 1 increment.

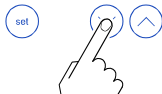

Press key >1 s:  
The value is increased / decreased continuously.



⇒ Save the modified parameter value.

## Vacuum Gauge Display AGD-100

### 4.5.1 Gauge Identification

Type of the selected gauge is displayed.



- ⇒ Pirani gauge  
(PVG-500, PVG-502) (default)
- ⇒ Pirani/Capacitive gauge  
(PCG-750, PCG-752)
- ⇒ Cold cathode/Pirani gauge  
(FRG-700, FRG-702)



### 4.5.2 Pressure unit

Unit of measured values, thresholds etc.





- ⇒ mbar (default)
- ⇒ Torr
- ⇒ Pascal

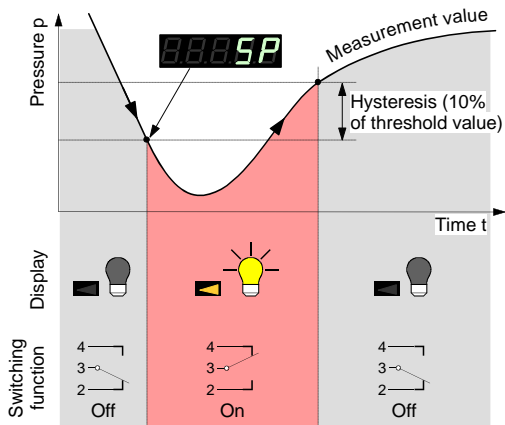

## 4.5.3 Switching threshold

The AGD-100 has a switching function with one adjustable threshold. The status of the switching function is displayed on the front panel (→ 21) and can be evaluated via the floating contact at the CONTROL connector (→ 19).



	Value
	The switching threshold defines the pressure at which the switching function is activated when the pressure is dropping.
e.g.: 	(default)

## 5 Maintenance, Repair

The product requires no maintenance.

### Cleaning the AGD-100

For cleaning the outside of the AGD-100, a slightly moist cloth will usually do. Do not use any aggressive or scouring cleaning agents.

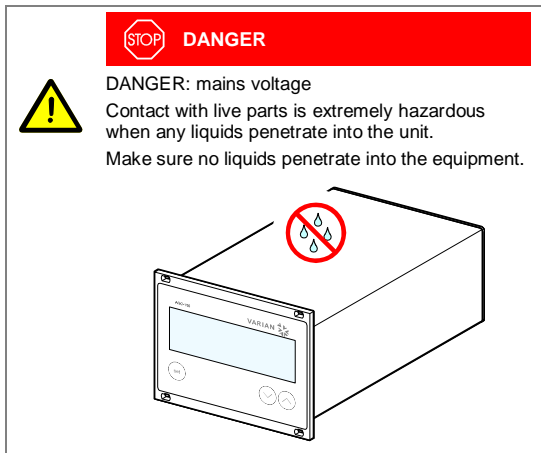



## 6 Troubleshooting





### Signalization of errors



### Error messages

	Possible cause and remedy / acknowledgement
	Interruption or instability in sensor line or connector (Sensor error).
	Possible cause and remedy / acknowledgement
	Pirani error (sensor defective). ⇒ Replace the sensor

### Status messages

	Possible cause and remedy / acknowledgement
	0.5 V < measurement signal < 1.5 V ⇒ Adjust the gauge (→  [1],[3],[4]).
	10.3 V < measurement signal < 13.7 V ⇒ Adjust the gauge (→  [1],[3],[4]).

## Vacuum Gauge Display AGD-100

### Technical support



If the problem persists after the message has been acknowledged for several times and/or the gauge has been exchanged, please contact your local Agilent service center.

## 7 Repair



Please contact your local Agilent service center.

Agilent assumes no liability and the warranty becomes null and void if repair work is carried out by the end-user or third parties.

## 8 Storage



### Caution



Caution: electronic component

Inappropriate storage (static electricity, humidity etc.) can damage electronic components.

Store the product in a bag or container. Observe the corresponding specifications in the technical data (→  12).



## 9 Disposal



### DANGER



**DANGER:** contaminated parts

Contaminated parts can be detrimental to health and environment.

Before beginning to work, find out whether any parts are contaminated. Adhere to the relevant regulations and take the necessary precautions when handling contaminated parts.



### WARNING



**WARNING:** substances detrimental to the environment

Products or parts thereof (mechanical and electric components, operating fluids etc.) can be detrimental to the environment.

Dispose of such substances in accordance with the relevant local regulations.



### Separating the components

After disassembling the product, separate its components according to the following criteria:





- Contaminated components  
Contaminated components (radioactive, toxic, caustic or biological hazard etc.) must be decontaminated in accordance with the relevant national regulations, separated according to their materials, and disposed of.
- Other components  
Such components must be separated according to their materials and recycled.

## Appendix

### A: Default Parameters

	Default	User	
	PVG		
	mbar		
	10 <sup>-3</sup> mbar		

### B: Literature

-  [1] [www.agilent.com](http://www.agilent.com)  
Operating Manual  
Pirani Standard Gauge  
PVG-500, PVG-502  
tqna69e1  
Agilent Technologies, Lexington, MA 02421, USA
-  [2] [www.agilent.com](http://www.agilent.com)  
Operating Manual  
Pirani Standard Gauge  
PVG-550, PVG-552  
tqna79e1  
Agilent Technologies, Lexington, MA 02421, USA
-  [3] [www.agilent.com](http://www.agilent.com)  
Operating Manual  
Pirani Capacitance Diaphragm Gauge  
PCG-750, PVG-752  
tqna77e1  
Agilent Technologies, Lexington, MA 02421, USA
-  [4] [www.agilent.com](http://www.agilent.com)  
Operating Manual  
Inverted Magnetron Pirani Gauge  
FRG-700, FRG-702  
tqna74e1  
Agilent Technologies, Lexington, MA 02421, USA

## Vacuum Gauge Display AGD-100

### Notes

## Vacuum Gauge Display AGD-100

### Notes

## Vacuum Products Division

### Instructions for returning products

Dear Customer:

Please follow these instructions whenever one of our products needs to be returned.

- 1) Complete the attached Request for Return form and send it to Agilent Technologies (see below), taking particular care to identify all products that have pumped or been exposed to any toxic or hazardous materials.
- 2) After evaluating the information, Agilent Technologies will provide you with a Return Authorization (RA) number via email or fax, as requested.  
Note: Depending on the type of return, a Purchase Order may be required at the time the Request for Return is submitted. We will quote any necessary services (evaluation, repair, special cleaning, eg).
- 3) Important steps for the shipment of returning product:
  - Remove all accessories from the core product (e.g. inlet screens, vent valves).
  - Prior to shipment, drain any oils or other liquids, purge or flush all gasses, and wipe off any excess residue.
  - If ordering an Advance Exchange product, **please use the packaging from the Advance Exchange to return the defective product.**
  - Seal the product in a plastic bag, and package product carefully to avoid damage in transit. You are responsible for loss or damage in transit.
  - Agilent Technologies is not responsible for returning customer provided packaging or containers.
  - Clearly label package with RA number. Using the shipping label provided will ensure the proper address and RA number are on the package. Packages shipped to Agilent without a RA clearly written on the outside cannot be accepted and will be returned.
- 4) Return only products for which the RA was issued.
- 5) Product being returned under a RA must be received within 15 business days.
- 6) Ship to the location specified on the printable label, which will be sent, along with the RA number, as soon as we have received all of the required information. Customer is responsible for freight charges on returning product.
- 7) Return shipments must comply with all applicable Shipping Regulations (IATA, DOT, etc.) and carrier requirements.

RETURN THE COMPLETED REQUEST FOR RETURN FORM TO YOUR NEAREST LOCATION:

**EUROPE:**  
Fax: 00 39 011 9979 330  
Fax Free: 00 800 345 345 00  
Toll Free: 00 800 234 234 00  
[vpt-customer-care@agilent.com](mailto:vpt-customer-care@agilent.com)

**NORTH AMERICA:**  
Fax: 1 781 860 9252  
Toll Free: 800 882 7426, Option 3  
[vpl-ra@agilent.com](mailto:vpl-ra@agilent.com)

**PACIFIC RIM:**  
please visit our website for individual  
office information  
<http://www.agilent.com>



Please read important policy information on Page 3 that applies to all returns.

1) CUSTOMER INFORMATION

Company Name:		Contact Name:	
Tel:	Email:	Fax:	
Customer Ship To:		Customer Bill To:	
Europe only: VAT reg. Number:		USA/Canada only: <input type="checkbox"/> Taxable <input type="checkbox"/> Non-taxable	

2) PRODUCT IDENTIFICATION

Product Description	Agilent P/N	Agilent S/N	Original Purchasing Reference

3) TYPE OF RETURN (Choose one from each row and supply Purchase Order if requesting a billable service)

- 3A.  Non-Billable  Billable **➡** New PO # (hard copy must be submitted with this form):
- 3B.  Exchange  Repair  Upgrade  Consignment/Demo  Calibration  Evaluation  Return for Credit

4) HEALTH and SAFETY CERTIFICATION

AGILENT TECHNOLOGIES CANNOT ACCEPT ANY PRODUCTS CONTAMINATED WITH BIOLOGICAL OR EXPLOSIVE HAZARDS, RADIOACTIVE MATERIAL, OR MERCURY AT ITS FACILITY.

Call Agilent Technologies to discuss alternatives if this requirement presents a problem.

The equipment listed above (check one):

- HAS NOT pumped or been exposed to any toxic or hazardous materials. OR
- HAS pumped or been exposed to the following toxic or hazardous materials. If this box is checked, the following information must also be filled out. Check boxes for all materials to which product(s) pumped or was exposed:
- Toxic  Corrosive  Reactive  Flammable  Explosive  Biological  Radioactive

List all toxic/hazardous materials. Include product name, chemical name, and chemical symbol or formula:

NOTE: If a product is received at Agilent which is contaminated with a toxic or hazardous material that was not disclosed, the customer will be held responsible for all costs incurred to ensure the safe handling of the product, and is liable for any harm or injury to Agilent employees as well as to any third party occurring as a result of exposure to toxic or hazardous materials present in the product.

Print Name: \_\_\_\_\_ Authorized Signature: \_\_\_\_\_ Date: \_\_\_\_\_

5) FAILURE INFORMATION:

Failure Mode (REQUIRED FIELD. See next page for suggestions of failure terms):

Detailed Description of Malfunction: (Please provide the error message)

Application (system and model):

I understand and agree to the terms of Section 6, Page 3/3.

Print Name: \_\_\_\_\_ Authorized Signature: \_\_\_\_\_ Date: \_\_\_\_\_



Please use these Failure Mode to describe the concern about the product on Page 2.

**TURBO PUMPS and TURBO CONTROLLERS**

APPARENT DEFECT/MALFUNCTION	POSITION	PARAMETERS
- Does not start - Does not spin freely - Does not reach full speed - Mechanical Contact - Cooling defective	- Noise - Vibrations - Leak - Overtemperature - Clotting	- Vertical - Horizontal - Upside-down - Other: _____  Power:           Rotational Speed: Current:        Inlet Pressure: Temp 1:         Foreline Pressure: Temp 2:         Purge flow: OPERATING TIME:

**ION PUMPS/CONTROLLERS**

- Bad feedthrough - Vacuum leak - Error code on display	- Poor vacuum - High voltage problem - Other
---	--

**VALVES/COMPONENTS**

- Main seal leak - Solenoid failure - Damaged sealing area	- Bellows leak - Damaged flange - Other
--	---

**LEAK DETECTORS**

- Cannot calibrate - Vacuum system unstable - Failed to start	- No zero/high background - Cannot reach test mode - Other
---	--

**INSTRUMENTS**

- Gauge tube not working - Communication failure - Error code on display	- Display problem - Degas not working - Other
--	---

**SCROLL AND ROTARY VANE PUMPS**

- Pump doesn't start - Doesn't reach vacuum - Pump seized	- Noisy pump (describe) - Over temperature - Other
---	--

**DIFFUSION PUMPS**

- Heater failure - Doesn't reach vacuum - Vacuum leak	- Electrical problem - Cooling coil damage - Other
---	--

**Section 6) ADDITIONAL TERMS**

Please read the terms and conditions below as they apply to all returns and are in addition to the Agilent Technologies Vacuum Product Division – Products and Services Terms of Sale.

- Customer is responsible for the freight charges for the returning product. Return shipments must comply with all applicable Shipping Regulations (ATA, DOT, etc.) and carrier requirements.
- Customers receiving an Advance Exchange product agree to return the defective, rebuildable part to Agilent Technologies within 15 business days. Failure to do so, or returning a non-rebuildable part (crashed), will result in an invoice for the non-returned/non-rebuildable part.
- Returns for credit toward the purchase of new or refurbished Products are subject to prior Agilent approval and may incur a restocking fee. Please reference the original purchase order number.
- Units returned for evaluation will be evaluated, and a quote for repair will be issued. If you choose to have the unit repaired, the cost of the evaluation will be deducted from the final repair pricing. A Purchase Order for the final repair price should be issued within 3 weeks of quotation date. Units without a Purchase Order for repair will be returned to the customer, and the evaluation fee will be invoiced.
- A Special Cleaning fee will apply to all exposed products per Section 4 of this document.
- If requesting a calibration service, units must be functionally capable of being calibrated.



# Service & Support

## North America

Agilent Technologies  
121 Harwell Avenue  
Lexington, MA 02421 USA  
Tel: +1 781 861 7200  
Toll-Free: +1 800 882 7426  
Fax: +1 781 860 5437  
vpl-customerservice@agilent.com

## Benelux

Agilent Technologies Netherlands B.V.  
Herculesweg 8  
4338 PL Middelburg The Netherlands  
Tel: +31 118 671570  
Fax: +31 118 671569  
Toll free: 00 800 234 234 00

## China

Agilent Technologies (China) Co. Ltd  
No.3, Wang Jing Bei Lu,  
Chao Yang District, Beijing,  
100102 China Tel: +86  
(10) 6439 7888  
Fax: +86 (10) 6439 1318  
Toll-Free: 800 820 8266  
vpc-customerservice@agilent.com

## France

Agilent Technologies France  
7 avenue des Tropiques  
Z.A. de Courtaboeuf – B.P. 12  
91941 Les Ulis cedex France  
Tel: +33 (0) 1 69 86 38 84  
Fax: +33 (0) 1 69 86 29 88  
Toll free: 00 800 234 234 00  
vpl.sales@agilent.com

## Germany & Austria

Agilent Technologies  
Lyoner Str. 20  
60 528 Frankfurt am Main Germany  
Tel: +49 69 6773 43 2230  
Fax: +49 69 6773 43 2250  
Toll free: 00 800 234 234 00

## India

Agilent Technologies India Pvt. Ltd.  
G01, Prime corporate Park,  
230/231, Sahar Road,  
Opp. Blue Dart Centre,  
Andheri (East), Mumbai – 400 099 India  
Tel: +91 22 30648267/8200  
Fax: +91 22 30648250  
Toll Free: 1800 113037  
cag\_india@agilent.com

## Italy

Agilent Technologies Italia S.p.A.  
via F.lli Varian 54  
10040 Leini, (Torino) Italy  
Tel: +39 011 997 9111  
Fax: +39 011 997 9350  
Toll-Free: 00 800 234 234 00  
vpt.sales@agilent.com  
vpt-customerservice@agilent.com

## Japan

Agilent Technologies Japan, Ltd.  
8th Floor  
Sumitomo Shibaura Building  
4-16-36 Shibaura Minato-ku  
Tokyo 108-0023 Japan  
Tel: +81 3 5232 1253  
Toll-Free: 0120 655 040  
Fax: +81 3 5232 1710  
vpj-customerservice@agilent.com

## Korea

Agilent Technologies Korea Ltd.  
Shinsa 2nd Bldg, 2F  
966-5 Daechi-dong  
Kangnam-gu, Seoul Korea 135-280  
Tel: +82 2 3452 2455  
Toll-Free: 080 222 2452  
Fax: +82 2 3452 2451  
vplk-customerservice@agilent.com

## Singapore

Agilent Technologies Singapore Pte Ltd  
No.1 Yishun Avenue 7 Singapore 768923  
Tel: +65 6215 8045  
Fax: +65 6754 0574  
Toll-Free: 1 800 2762622  
vps-customerservice@agilent.com

## South East Asia

Agilent Technologies Sales Sdn Bhd  
Unit 201, Level 2 uptown 2,  
2 Jalan SS21/37, Damansara Uptown  
47400 Petaling Jaya, Selangor, Malaysia  
Tel: +603 7712 6106  
Fax: +603 6733 8121  
Toll-Free: 1 800 880 805  
vpi-customerservice@agilent.com

## Taiwan

Agilent Technologies Taiwan Limited  
20 Kao-Shuang Rd.,  
Pin-Chen City, 324  
Taoyuan Hsien, Taiwan, R.O.C.  
Tel: +886 34959281  
Toll Free: 0800 051 342  
vpu-customerservice@agilent.com

## UK & Ireland

Agilent Technologies UK Ltd  
6 Mead Road  
Oxford Industrial Park  
Yarnton, Oxford OX5 1QU UK  
Tel: +44 (0) 1865 291570  
Fax: +44 (0) 1865 291571  
Toll free: 00 800 234 234 00  
vpt-customerservice@agilent.com

Learn more:

[www.agilent.com/chem/vacuum](http://www.agilent.com/chem/vacuum)

This information is subject to change without notice.

© Agilent Technologies, Inc., 2011  
Published in USA, October, 2011



**Agilent Technologies**