



**PrismaPro[®] QMG 250 M1, 1 – 100
u, open ion source, tungsten, I/O-
option: Standard**



Similar Image

PrismaPro® QMG 250 M1, 1 – 100 u, open ion source, tungsten, I/O-option: Standard

- PV MassSpec software for Windows 10, 8.1 & 7 for recording, saving and displaying measured data
- Leak detection and vacuum diagnosis with a click
- Easy definition of measurement recipes
- Low detection limit

Dimensions

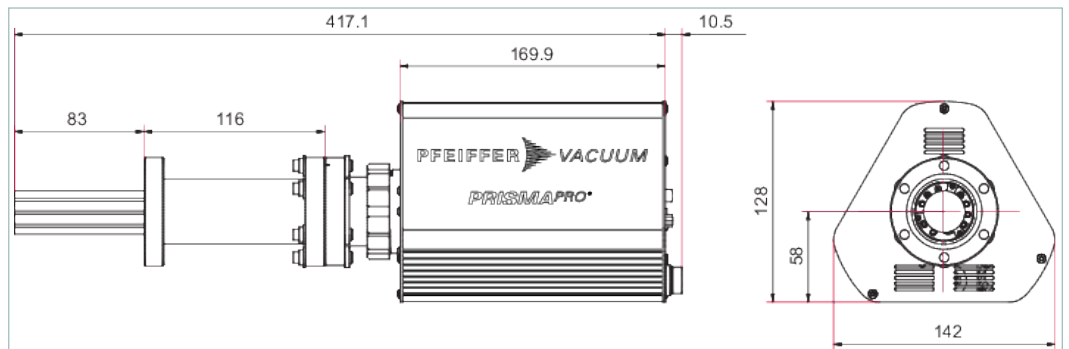

Technical Data	PrismaPro® QMG 250 M1, 1 – 100 u, open ion source, tungsten, I/O-option: Standard
Ambient temperature: analyzer	150 °C 302 °F 423 K
Bakeout temperature: analyzer	300 °C 572 °F 573 K
Connection	0°
Connection flange (in)	DN 40 CF-F
Contribution to neighboring mass: 40 to 41	10 ppm
Detection limit min.: C-SEM (hPa)	$3 \cdot 10^{-15}$ hPa $2.25 \cdot 10^{-15}$ Torr $3 \cdot 10^{-15}$ mbar
Detector	C-SEM/Faraday
Filament	Tungsten
I/O interfaces	Standard interface
Input: Analog	1x ± 10 V / 12 Bit
Input: Digital	2x, 24 V
Ion source	Open, 2 filaments
Mass range	1 – 100 u
Measuring speed	1 ms/u - 16 s/u
Mounting orientation	Arbitrary
Operating pressure max.: C-SEM	$5 \cdot 10^{-5}$ hPa $3.75 \cdot 10^{-5}$ Torr $5 \cdot 10^{-5}$ mbar
Operating pressure max.: Faraday	$5 \cdot 10^{-4}$ hPa $3.75 \cdot 10^{-4}$ Torr $5 \cdot 10^{-4}$ mbar
Operating pressure max.: SEM	$5 \cdot 10^{-5}$ hPa $3.75 \cdot 10^{-5}$ Torr $5 \cdot 10^{-5}$ mbar
Peak ratio reproducibility	0.5 %
Relay: Number	1 Pcs.
Resolution, adjustable at 10 % peak height	0.5 – 2.5 u
Rod system: Diameter	6 mm 0.24 inch
Rod system: Length	125 mm 4.92 inch
Sensitivity for Ar: Faraday	$5 \cdot 10^{-4}$ A/hPa
Supply: Voltage V AC	100 – 240 V AC
Weight	3.2 kg 7.05 lb

Order number

PrismaPro® QMG 250 M1

PT M16 111 210

VACUUM SOLUTIONS FROM A SINGLE SOURCE

Pfeiffer Vacuum stands for innovative and custom vacuum solutions worldwide, technological perfection, competent advice and reliable service.

COMPLETE RANGE OF PRODUCTS

From a single component to complex systems:

We are the only supplier of vacuum technology that provides a complete product portfolio.

COMPETENCE IN THEORY AND PRACTICE

Benefit from our know-how and our portfolio of training opportunities!

We support you with your plant layout and provide first-class on-site service worldwide.

Are you looking for a
perfect vacuum solution?
Please contact us:

Pfeiffer Vacuum GmbH
Headquarters · Germany
T +49 6441 802-0
info@pfeiffer-vacuum.de

www.pfeiffer-vacuum.com

All data subject to change without prior notice.

PFEIFFER  **VACUUM**