

Agilent Technologies
Helium Leak Detection



Agilent Leak Detection

2-3	The Agilent Advantage
4-20	Leak Detection Instruments
21-25	Accessories and Options
26	Global Support Network
27	Field & Factory Support Program
28-29	Training
30-31	Advantages of Helium Leak Detection
32-33	Leak Detection Methods
34-37	Typical Applications
38-39	Design and Application Considerations
40-41	Technical Notes



Agilent Leak Detection

The Agilent Advantage

Rigorous standards in today's manufacturing and research and development environments require complete leak detection solutions. *The Agilent Advantage* offers a comprehensive solution the primary component of which is our commitment to Maximize your Productivity and Uptime.

Key components of The Agilent Advantage:

- Global Applications Support
- High Performance Instruments
- Industry Leading Service and Support

VS Series

- Easy, two button operation with fully automated start-up and calibration.
- Color touch screen display allows users to program several test parameters.
- Can select from several languages and measurement units.
- Available with wireless remote.

VS C15

- The most compact, easiest to integrate component system available – more than 50 % smaller than competitive systems.
- Only 2 cables, power and communications.
- Comprehensive interface options – serial, analog, discrete I/O and Profinet.
- Selectable sensitivity scales and Contra-Flow vacuum design for fast, accurate measurements with maximum protection from contamination in industrial applications.

959 Leak Detector

- Rugged, easy to use, idea for many industrial applications.
- Single button test activation, automatic pump down and transfer into test mode.
- Vacuum testing at high inlet pressures – up to 1 Torr – shortens time-to-test.
- Auto-protection from test port overpressure, power failures and operator errors.
- Wet and dry versions available.

High Performance Instruments



PHD-4

- Sensitivity and portability in a very economical package.
- Easy to use – no training required.
- Battery power, and light weight (2.6 kg (5.7lbs)), make it ideal for field maintenance applications.

Leak Detection



Application Notes and Literature

Our offering of technical information guides you to the most appropriate leak detection method or system design for your specific application.

- Application notes are available at no cost.
- Agilent handbooks on leak detection principles, operation, and techniques.



Global Applications Support

Maximize
Your
Productivity
and System
Uptime

Global Applications Support

Expertise When & Where You Need It

- Toll-free hotlines provide easy accessibility to live, front-end support.
- Worldwide customer service representatives assist you with order status, pricing and delivery, and service information.
- Native language applications specialists available locally, worldwide.
- Application specific consulting.
- More than ten thousand installed systems delivering application solutions to customers in a broad range of industries.



Industry Leading Service & Support

Get the Most from Your Investment

- Extensive network of service engineers available to meet your needs.
- Flexible, comprehensive service plans provide service and support for years of trouble-free operation.
- Services include applications assistance, start-up support, vacuum and leak detection training, comprehensive maintenance, service agreements, and warranty extensions.
- Competent Technical support engineers are to respond with technical product data, troubleshooting, and literature.

Industry Leading Service and Support



Complete Line of Vacuum Pumps

Agilent is a Total Vacuum Solutions provider, offering a comprehensive choice of vacuum pumps.

- Rotary vane and dry scroll primary pumps.
- Turbo/drag high vacuum pumps.
- Specifically designed for leak detection applications.
- See page 20 and dedicated sections of the Agilent catalog for more information.

Leak
Detection

Agilent Leak Detection Instruments

Primary Pumps

Nominal Pumping Speed m³/hr (l/min)

Sensitivity Ranges atm cc/sec

Minimum Detectable Leak

Maximum Test Port Pressure

Calibration

Background Suppression

Communication Interface

Set Points

Remote Display/Control

Shipping Weight (base unit) kg (lbs)

Compliance to Norms

Mass Spectrometer Leak Detectors (MSLD)

	Portable		Bench Mount		Mobile	
	VS PR02	VS PD03	VS BR15	VS BD30	VS MR15	VS MD30
Primary Pumps	DS 42 RVP	Dry pump combo	DS 302	TriScroll 620	DS 302	TriScroll 620
Nominal Pumping Speed	2 (34)	3 (50)	14 (232)	30 (500)	14 (232)	30 (500)
Sensitivity Ranges	5 x 10 ⁻¹²					
Minimum Detectable Leak	5 x 10 ⁻¹² atm cc/sec: 5 x 10 ⁻¹² mbar l/s: 5 x 10 ⁻¹³ Pa m ³ /sec					
Maximum Test Port Pressure	13 mbar: 10 Torr: 1330 Pa					
Calibration	Automated or Manual (Internal or External)					
Background Suppression	Push Button Initiated Auto Zero, and Auto Zero < Zero Function					
Communication Interface	RS232 and analog (standard), Discrete IO (optional)					
Set Points	5 Set Points Standard, N/O or N/C; 3 Leak Rate, 1 Pressure, 1 Audio					
Remote Display/Control	-					
Shipping Weight (base unit)	63 (140)	57 (125)	75 (165)	83 (183)	105 (230)	114 (250)
Compliance to Norms	CE, UL/CSA					



VS PR02



VS MR15



VS MD30

Leak Detection

Mobile 959	Component VS C15	Selective Ion Pump Detector Portable Sniffer PHD-4
Dry Scroll or Rotary Vane	Turbo	
Options as required	Options as required	
1 x 10 ⁻⁴ through 1 x 10 ⁻⁸	4 working ranges covering	
2 x 10 ⁻⁹ atm cc/sec	1 x 10 ⁻³ to 1 x 10 ⁻⁹ atm cc/sec	5 x 10 ⁻⁶ atm cc/sec 5 x 10 ⁻⁶ mbar l/s 5 x 10 ⁻⁷ Pa m ³ /sec
1 Torr	5 Torr, 7 mbar, 667 Pa	-
Manual	Automated or manual (internal or external)	-
Manual	Auto zero, and auto zero < zero function	Automatic/Manual
Analog	RS232, analog, discrete IO, and Profinet	Standard Analog and RS-232 Serial Output
-	5 set points: 4 leak rate and/or pressure, 1 audio	-
-	Optional	-
23 (50)	Base Unit: 9 (19.8)	2.6 (5.7)
-	UL/CSA, CE Approved	CE, CSA/US



959



VS C15

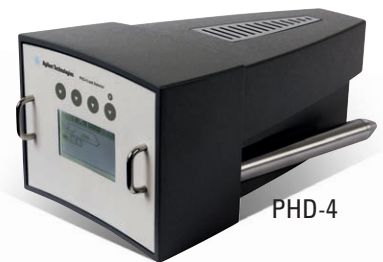

PHD-4

Leak
Detection

Agilent Leak Detection Instruments

Agilent VS Series

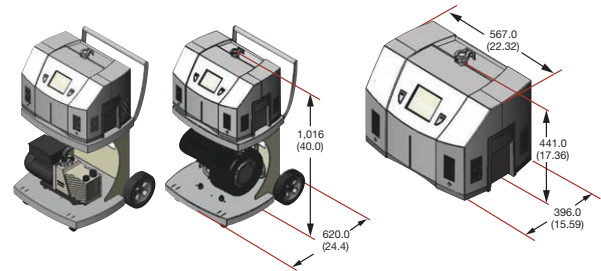

Dimensions: millimeters (inches)

VS Series leak detectors combine the simplicity of two-button operation with advanced system intelligence. Start and vent buttons permit simple day-to-day operation. User-friendly software offers intuitive navigation to vast system capabilities. Programmable test sequences simplify daily operation, minimize operator error, and maximize production efficiency. The TFT-style touch screen features high definition and brightness with wide viewing angles. Setup for worldwide use, these leak detectors can be operated in multiple languages – English, French, German, Spanish, Korean, Japanese and Chinese – and units of measure. And the VS Series conforms to CE, UL and CSA standards, assuring global acceptance. VS Series leak detectors employ Agilent’s primary pumps – rotary vane or scroll – and high vacuum pumps that deliver high inlet pumping speed and inlet pressure tolerance, minimizing test cycle time and maximizing production throughput.

State-of-the-art spectrometer and vacuum system design enable a broad range of test methods for specific applications. The high efficiency ion source and beam optics optimize sensitivity and mass separation, giving the VS Series very high sensitivity to meet the most stringent leak test requirements. At the same time, these leak detectors enjoy high test port pressure tolerance which permits detection of large leaks. In addition, high helium pumping speed ensures fast system response and clean-up times. Primary pump and system mounting options may be selected to best suit application requirements and test environments, and the compact, lightweight design enables easy transport from one application to another. Robust design innovations allow the VS Series to conform to the most rigorous industrial standards and operate dependently in the most challenging environments.

Technical Specifications

Model Number	PR02 & PD03	MR15 & MD30
Configuration options	Portable	Mobile
Primary pump type	Rotary vane pump Dry scroll pump	DS-302 14 m ³ /hr (232 l/m) TS-620 30 m ³ /hr (500 l/m)
Minimum detectable leak at 1000 ppm ambient helium	5 x 10 ⁻¹² atm cc/sec; 5 x 10 ⁻¹² mbar l/s; 5 x 10 ⁻¹³ Pa m ³ /sec helium	
Maximum test port pressure	13 mbar, 10 Torr, 1330 Pa	
Helium pumping speed @ test port (fine test)	1.8 l/s	
Calibration routine	Automated or manual (internal or external)	
Background suppression	Push button initiated auto zero, and auto zero < zero function	
User interface	High clarity, color display, TFT touch screen	
Selectable languages	English, French, German, Japanese, Korean, Mandarin, Spanish	
Automated cycling	Programmable rough time, test time, reject set points	
Response time	< 0.5 seconds	
Set points	Standard, 5 set points, N/O or N/C; 3 leak rate, 1 pressure, 1 audio	
Communications interface	RS232 and analog (standard), Discrete IO (optional)	
Conformance standards	UL/CSA, CE	

Leak Detection

Ordering Information

Description		Shipping Weight kg (lbs)	Part Number
VS Series Leak Detectors			
VS PR02 portable leak detector, DS 42 rotary vane pump	120 V	63 (140)	VSPR021
VS PR02 portable leak detector, DS 42 rotary vane pump	220 V	63 (140)	VSPR022
VS PD03 portable leak detector, dry pump combination	120 V	57 (125)	VSPD031
VS PD03 portable leak detector, dry pump combination	220 V	57 (125)	VSPD032
VS MR15 mobile leak detector, DS 302 rotary vane pump	120 V	105 (230)	VSMR151
VS MR15 mobile leak detector, DS 302 rotary vane pump	220 V	105 (230)	VSMR152
VS MD30 mobile leak detector, TS 620 dry scroll pump	120 V	114 (250)	VSMD301
VS MD30 mobile leak detector, TS 620 dry scroll pump	220 V	114 (250)	VSMD302
VS BR15 bench mount leak detector, DS 302 rotary vane pump	120 V	75 (165)	VSBR151
VS BR15 bench mount leak detector, DS 302 rotary vane pump	220 V	75 (165)	VSBR152
VS BD30 bench mount leak detector, TS 620 dry scroll pump	120 V	83 (183)	VSBD301
VS BD30 bench mount leak detector, TS 620 dry scroll pump	220 V	83 (183)	VSBD302

Accessories	Factory Installed	Field Installed
Oil mist eliminator, PR02 only	VSFACME	VSFLDME
Wireless remote, base unit	VSFACWB	VSFLDWB
Hand-held remote control		VSLDWRC
Discrete I/O	VSFACIO	VSFLDIO
Leak Test Data Wizard software		VSLTDW
1½ in. compression test port		VSFLDCP
Power probe sniffer, NW25		K9565306

Power Cords

Rating	Country Where Used	Length	Safety Approval	Part Number
16A/250 V	China	2.5 m	CCEE	R2984001
15A/125 V	Japan, Philippines, Thailand	2.5 m	PSE	R2983001
20A/250 V	North America	2.5 m	UL, CSA	R0460001
20A/125 V	North America	2.5 m	UL, CSA	R2840001
15A/250 V	UK, Ireland, Hong-Kong, Malaysia, Singapore	2.5 m	BSI	R2841001
15A/250 V	Europe, Korea, Indonesia	2.5 m	VDE, KEMA CEBEC, SETI, NEMKO, OVE DEMKO, SEV	R2842001
16A/250 V	Denmark, Switzerland	2.5 m	VDE, HAR, TUV	R2843001
16A/250 V	Israel	2.5 m	SII 32	R2844001
16A/250 V	India, South Africa	2.5 m	SABS	R2845001
15A/250 V	Australia, New Zealand	2.5 m	SAA	R2989001

Support Plans – see page 26

Additional options and accessories – see page 21 through 25

Agilent Leak Detection Instruments

Agilent Wireless Remote for VS Series Leak Detectors



Leaks in large systems often occur far from the leak detector. Wired remote controls have sought to address this problem, but impedance and the cumbersome nature of long cables are often limiting factors. For many applications these traditional wired remotes provide little benefit. By utilizing modern wireless technology, leak testing hard-to-reach locations is now much easier, and can be performed at much greater distances of up to 100 meters.

Applications in large systems which have traditionally required two technicians can now be performed by one technician, thereby reducing labor costs. All the major functions of the leak detector are at your fingertips, giving you a truly portable leak detection solution.

In addition to the visual bar graph of the leak rate, the remote control has a speaker that provides a variable tone indicating the trend and relative size of the leak. The wireless remote can operate for a full 8-hour shift, or longer, on four AA batteries and conforms to ISM band, 2.4 GHz FHSS standards.

Applications

Vacuum Furnaces
Glass Coaters
Roll Coaters
E-Beam Welders
Beam Lines/Accelerators
Semiconductor Process Tools
Ion Implanters
Power Generation Plants

Features

- Wireless technology
- 100 meter (328 ft) range
- Internal speaker
- Head phone jack
- 20 channels
- 2.4 GHz frequency, ISM band compliant

Benefits

- Significantly extends range without cumbersome, restrictive cables
- Enables single operator testing
- Emits variable tone that corresponds to leak rate signal
- Enables testing even in noisy environments
- Allows use of hand held remote with multiple leak detectors
- Free license band with minimum cross-talk

Technical Specifications

Frequency/Band	2.4 GHz, ISM Band FHSS Compliant
Range	100 m (328 ft)
Functions	Test/Hold, Zero, Read standard leak, Set-up
Power supply	4 (four) AA Batteries or by 5.6 1 VDC, 1 A (min)
Operating life	Approximately 12 hrs (dependent on batteries)
Internal speaker	85 dB min @ 1.0 ft
Head phones	Mono, 3.5 mm plug, 32 ohm impedance, 1000-10,000 Hz frequency response
Operating temperature	+12 °C to +40 °C
Ruggedness	Meets industrial standards for hand-held equipment (Section 8.4.2 of UL 61010-1 2nd edition)

Ordering Information

Description	Shipping Weight kg (lbs)	Part Number
Wireless base unit, field installed	0.5 (1.0)	VSFLDWB
Wireless base unit, factory installed		VSFACWB
Wireless remote control	1.0 (2.2)	VSLDWRC

Leak Detection

Leak Test Data Wizard for VS Series Leak Detectors



Capturing and analyzing leak test data are increasingly critical to the leak test process. Aggressive manufacturing yield and efficiency targets, demanding quality control procedures, and ISO and regulatory compliance requirements have created a need for a capable, user-friendly data management tool. To meet this need, Agilent has designed the Leak Test Data Wizard, a comprehensive data management software package for use with our VS Series mass spectrometer leak detectors. The Leak Test Data Wizard is a flexible PC based, graphic-rich tool that makes full use of the data from the VS leak detector to customize automation of basic leak test processes, assuring testing uniformity over time or between operators. Messages can be created that guide your operators step-by-step through your testing process. Once a specific test is developed for a particular part or system, it can be saved and recalled for future use. Results from leak tests are graphically displayed in easy to read formats to provide individual part test histories, or to clearly identify trends in high volume test applications. All this can be accomplished without costly third party support.

Features

- Data recording and plotting mode
- Multiple parts testing mode
- Four reject set points with custom messaging capability
- Background test set-up function
- Leak test library
- Graphical display of test results in easy to read formats

Benefits

- Stores and plots leak rate vs. time and pressure vs. time data for analysis
- Basic automation of a leak testing process without the need for third party support
- Custom messages guide operator through step-by-step process
- Identify bad parts early in the testing cycle
- Allows access to previous test set-ups
- Clearly track trends during the testing process

Minimum System Requirements

- Windows version 98, 2000, or XP required
- PC with 266 MHz or higher processor (Intel Pentium II or higher)
- CD-ROM drive for installation
- Minimum 384 MB total RAM
- 25 MB available hard disk space for installation

Ordering Information

Description	Shipping Weight kg (lbs)	Part Number
Leak Test Data Wizard	0.2 (0.5)	VSLTDW

VS Series Features and Benefits



Easy-to-Use – Two Button Operation

VS Series Leak Detectors combine the simplicity of two-button operation with advanced expert system intelligence.

- Fully automated start-up and calibration maximizes productivity
- Intuitive menu structure is easy to navigate
- Programmable test sequences improves testing efficiency
- Color touch screen provides excellent clarity, even at wide angles



Powerful – Broad Range of Test Methods

The state-of-the-art spectrometer and vacuum system design provides powerful capability, enabling a broad range of test methods for specific applications.

- High test port pressure allows for detection of large leaks
- 5×10^{-12} MDL (sensitivity) meets the most stringent leak test requirements
- High helium pumping speed ensures fast system response and clean-up times
- New high efficiency ion source and beam optics optimize sensitivity and mass separation



Versatile – Multiple System Configurations

A wide range of options allows for broad configuration flexibility, meeting all application requirements and test environments.

- Primary pump and system mounting options may be selected to best suit your needs
- Multiple language and units capability permits easy implementation worldwide
- Compact lightweight design enables easy transport from one application to another



Dependable – Robust Design

Robust design innovations allow the VS series to conform to the most rigorous industrial standards and operate dependably in the most challenging environments.

- Fast clean-up time enhances system up-time
- Robust Faraday cup technology delivers proven reliability with low cost of ownership
- Conforms to CE, UL and CSA standards, assuring global acceptance



Truly Portable – Wireless Remote Control/Display

Hand-held remote performs essential functions up to 100 meters (328 feet) indoors, facilitating access to all leak sites.

- Eliminates cumbersome cables while extending range
- Allows testing of large systems by a single operator
- Leak detector can be located outside cleanroom to prevent contamination
- Multiple channels for use of one remote with up to ten leak detectors

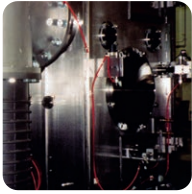

Industrial Process Tools

VS Series Leak Detectors can help rid your process tool of costly and inefficient leaks. Robust system features assure reliable operation in the most challenging industrial environments. Superior pumping characteristics such as high inlet pressure tolerance and split flow capability deliver fast response and clean-up times. Wireless remote control enables single-person leak testing of even the largest systems.

- Vacuum furnaces
- Coating systems
- Electronic beam welders



Power Generation

Leaks within power plant condensers can cause a significant loss of efficiency. High inlet pressure tolerance, auto-zero function, and mobility of the two-wheel cart option simplify the leak detection process. Simple, intuitive operation allows intermittent use without excessive training requirements. Wireless remote control with an operating range of 100 meters (328 feet) provides true hand-held portability, enabling leak testing by a single operator.

- Condensers
- Heat exchangers
- Steam circuits
- Underground pressured power cables



High Energy Physics

High sensitivity, large roughing capacity and portability are essential for leak testing accelerators and beam lines. These instruments provide excellent mass separation that differentiates the smallest helium leaks from residual water vapor and hydrogen, and are available with large, dry roughing pumps to evacuate large volumes, or smaller internal pumps when used with turbo pumping systems. Wireless remote control with an operating range of 100 meters (328 feet) enables a single operator to check potential leak sites without a cord of any kind.

- Accelerators
- Beam lines
- Synchrotrons



Semiconductor Production

VS Series Leak Detectors combine high sensitivity and large, dry rough pumping capacity to meet the testing needs of semiconductor processing equipment and gas handling systems. With the high inlet pressure tolerance and fast clean up and response times, these units excel at locating leaks in both evacuated and pressurized systems. A clean room technician can use the hand-held wireless remote control while the leak detector remains installed in a less critical area.

- Process tools
- Gas panels
- Gas transfer lines



Small Parts Manufacturing

VS Series Leak Detectors employ high inlet pumping speed and high inlet pressure tolerance to minimize test cycle time, thereby maximizing production throughput. Programmable test sequences simplify daily operation, minimize operator error, and maximize your production efficiency. Optional "Leak Test Data Wizard" software can be used to collect data for quality control purposes and even automate test cycles.

- Automotive
- Electrical
- Refrigeration
- Hermetic packaging
- Medical & Implantable devices



General R&D

Research and university labs often require a portable leak detector with the versatility to cover a wide range of applications. The ability to be easily moved from lab to lab, in conjunction with high performance specifications in both the evacuation and pressurized mode, make the VS Series an essential tool for this environment.

- Electron microscopes
- Experimental chambers
- Surface analytical systems
- Space chambers

Agilent Leak Detection Instruments

Agilent VS C15 Component Leak Detector

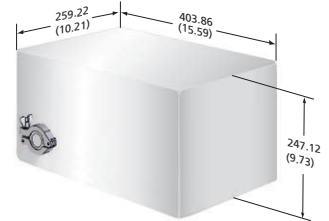
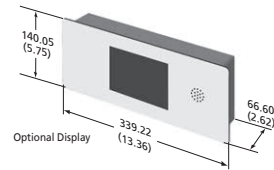

UL/CSA, CE Approved

Dimensions: millimeters (inches)

The VS C15 Component Leak Detector is a simple solution to the complex task of leak detection integration.

- Compact housing minimizes space requirements – everything needed to do the job is located within one box. Over 50% reduction in space when compared to competitive systems
- Simplified interface with only two cables required, one for power, one for communications
- Does not require mounting modules or bulky, expensive interconnecting cables that are found standard in most leak detection systems today
- Most comprehensive array of interface options, including serial, discrete I/O and Profinet. Other interface options to be made available when required.

- Optional color touch screen display allows access to system status information and all operating parameters
- Critical leak detector components are safely housed in a single enclosure protecting them from the industrial environment
- Selectable sensitivity scales and a Contra-Flow vacuum design ensures fast, accurate measurements while maximizing protection from contamination in industrial applications
- Calibrated leak (10^{-7} range) included
- Widest operating temperature range, suitable for warm factory environments.

Technical Specifications

Minimum detectable leak	5×10^{-10} atm cc/sec; 5×10^{-10} mbar l/s; 5×10^{-11} Pa m ³ /sec
Selectable sensitivity ranges	4 working ranges covering 1×10^{-3} to 1×10^{-9} atm cc/sec
Maximum test port pressure	5 Torr, 7 mbar, 667 Pa
Calibration routine	Automated or manual (internal or external)
Background suppression	Auto zero, and auto zero < zero function
Display interface (optional)	High clarity TFT color touch screen
Display – Selectable languages	English, French, German, Spanish, Japanese, Korean, Mandarin
Set points	5 set points: 4 leak rate and/or pressure, 1 audio
Analog output	0-10 V, log 1 V/decade & 2 V/decade and linear (DB-9F)
Serial interface	RS-232 isolated interface @9600 baud (DB-9M)
Discrete I/O	Optically isolated, 5-24 VDC outputs and inputs (DB-25S)
Networking interface (optional)	Profinet I/O option (RJ45)
Power input	24 VDC: $\pm 5\%$; Max current: 4 A (Molex 03-12-1036)
Operating temperature	5 to 48 °C

Leak Detection

Ordering Information

Description	Shipping Weight kg (lbs)	Part Number
VS C15 base unit	9.0 (19.8)	VSC15BU
Options and accessories		
Display and display cable – 10 ft.	3.5 (7.8)	VSC15DU
Display cable – 10 ft.	0.2 (0.5)	VSCDUC10
24 V external power supply	0.8 (1.7)	VSC15PS
Power cord for power supply – 8 ft.	0.5 (1.0)	VSCBUPC8
ConvecTorr gauge – 1/8 in. NPT	0.5 (1.0)	L9090301
ConvecTorr gauge – NW 16 KF	0.5 (1.0)	L9090305
ConvecTorr gauge – NW 25 KF	0.5 (1.0)	L9090306
Remote gauge cable – 10 ft.	0.2 (0.5)	VSCCTC10
Remote Gauge Cable – 25 ft.	0.2 (0.5)	VSCCTC25
Profinet interface card – factory installed	–	VSCFACPN
Profinet interface card – field installed	0.5 (1.0)	VSCFLDPN

For information on Support Plans, refer to page 26.

For information on leak detector options and accessories, refer to page 21 through 25.

For information on roughing pumps, refer to page 20.

Agilent Leak Detection Instruments

Agilent 959

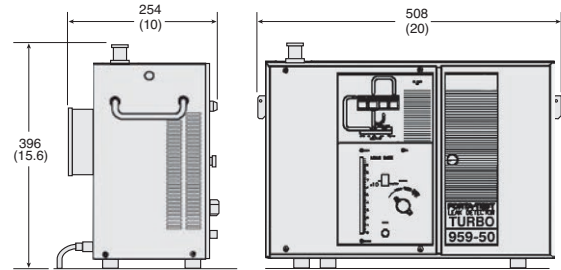

on 2-Wheel Cart

The 959 MacroTorr Helium Leak Detector fulfills the need for a rugged and dependable leak detector in the most demanding industrial applications. With its low price and cost of ownership, this unit is the most cost effective leak detector available. It is available in stand-alone, bench-top, and two-wheel cart configurations. We have designed these units with large externally-mounted primary pumps that deliver high roughing speeds for fast pump down times. The bench-top and cart-mounted versions are available with Agilent DS 302 rotary vane pumps or TriScroll 320 dry pumps.

- External mounting of large primary pumps results in fast pump down cycles
- High test port pressure tolerance reduces time required to reach test mode
- Available in wet and dry versions, on two- or four-wheel carts, or bench-top
- Simple, rugged design provides the cost effective solution for many applications

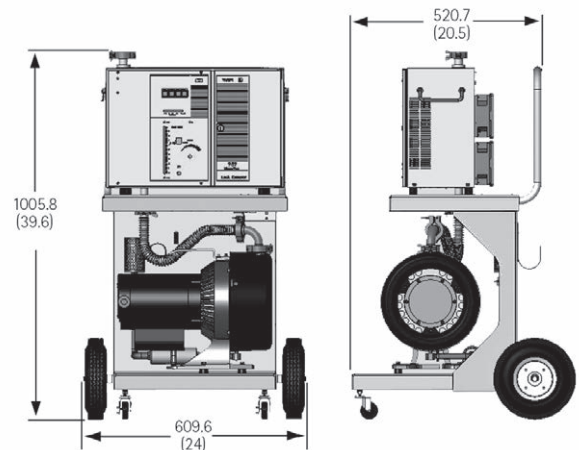

Dimensions: millimeters (inches)

Technical Specifications

Sensitivity ranges	10 ⁻⁴ thru 10 ⁻⁸ atm cc/sec
Minimum detectable leak at 1000 ppm ambient helium	2 x 10 ⁻⁹ atm cc/sec helium
Maximum test port pressure	1 Torr
High vacuum pump	V70D MacroTorr turbo/drag pump
Primary pump type	Rotary vane pump DS 302
	Dry scroll pump TS 320
Inlet flange	NW-25 (optional 1 1/8" compression adapter)
Calibration routine	Manual
Background suppression	Manual
Leak indication	50 segment bar graph w/exponent display
Leak units displayed	Atmospheric cc/sec.
Ranging	Manual
Analog leak rate output (plug)	Phone jack, 0-5 VDC
Audio alarm	Threshold and volume control (103 dBA maximum @ 1 ft.) and output jack for remote speaker
Electronic response time	2 seconds
Recommended ambient operating temperature	5 to 35 °C
Power requirements	115 V or 230 V, 50/60 Hz (15/20 amps)
Weight, base unit	22.7 kg (50 lbs)

Leak Detection

Ordering Information

Configuration	Base	Part Number		
		x = Mounting	x = Sensitivity	xxx = Voltage
Stand-Alone (Pumps not Included)*	S9590000xxxxx	• 0 (None supplied)		
Single Rotary Vane Pump DS-302	L9593000xxxxx	• B = Bench • T = Two-wheel	• M = Standard Sensitivity	• 120 • 220
Single Dry Scroll Pump TS-320	D9593500xxxxx	• B = Bench • T = Two-wheel		

Description	Shipping Weight kg (lbs)	Part Number
Accessories and Options		
Sniffer probe, NW25, 10' hose	1.8 (4)	K9565306
Sniffer probe, NW25, 25' hose	1.8 (4)	K9565307
Calibrated leak, external, NW25, 10 ⁻⁷ range (NIST-traceable)	1.8 (4)	F8473321
Calibrated leak, external, NW25, 10 ⁻⁸ range (NIST-traceable)	1.8 (4)	F8473322
Tuning leak/throttle valve, NW25	2.3 (5)	R1947301
Spectrometer tube cleaning kit	1.4 (3)	670029096
Replacement Parts		
O-ring kit	0.9 (2)	L6930301
Ion Source, thoriated iridium	0.1 (0.2)	82850302
Preamplifier, MacroTorr	0.5 (1)	L9030301
Manual	1.4 (3)	699909745

* 959 sensitivity is influenced by the speed of the system's primary pump. The above specifications are obtained with a nominal 10 cfm displacement pump.

For information on Support Plans, refer to page 26.

For information on pump options, refer to page 20.

For information on additional accessories and options, refer to pages 21 through 25.

Agilent Leak Detection Instruments

Agilent PHD-4

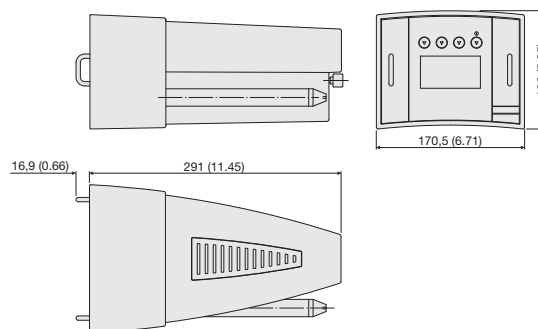

Dimensions: millimeters (inches)

The PHD-4 is a portable, compact leak detector that runs on its own battery for up to four hours. Weighing only 2.6 kg (5.7 lbs) including the battery, it can be taken anywhere. The PHD-4 detects very small leaks in objects that have a slight helium/air pressure inside. It is sensitive to helium concentrations as small as 2 parts per million which equivalent to a leak rate of 5×10^{-6} atm-cc/sec. This level of sensitivity is far superior to the performance of other means of detecting leaks such as bubble testing. To accomplish this it relies on Agilent's proprietary and patented Selective Ion Pump Detection (SIPD) technology. Controlled by a microprocessor, the PHD-4 is easy to use with no training required. All tuning and zeroing are handled automatically. The display can be set to use any of four languages – English, French, German, and Italian.

The basic PHD-4 package includes:

- PHD-4 basic module
- Transformer/battery charger (115 V-240 V)
- Carrying strap
- 15-pin I/O connector
- Instruction manual on CD-ROM

The complete PHD-4 package includes everything in the basic package plus:

- Spare battery
- Travel case
- Probe set

The PHD-4 replacement kit includes:

- Sampling pump with fittings
- Probe with sampling line
- Probe tip filter
- Internal filter kit (5 units)

Technical Specifications

Lowest detectable helium concentration	2 ppm (parts per million)		
Lowest detectable helium leak	5×10^{-6} mbar l/s	5×10^{-6} atm cc/s	5×10^{-7} Pa m ³ /s
Response time	< 2 sec		
Recovery time	<10 sec (from 50 ppm to 0 ppm)		
Start up time, including self check-up	3 min approx.		
Electrical supply	<ul style="list-style-type: none"> • Rechargeable battery included • Power supply included 110-240 V 50-60 Hz 		
Battery operation time	4 hours		
Maximum signal drift	10 ppm/10 min		
Operating conditions	Temperature: +5 °C to +35 °C Humidity: 90% maximum relative humidity		
Storage conditions	Temperature: -20 °C to +60 °C Weight: 2,6 kg (5.7 lbs)		
Compliance to norms	CE, CSA/US approved		

Leak Detection

Ordering Information

PHD-4 Complete Package	Part Number
Travel Case includes	9694640
• PHD-4 basic unit	
• Spare battery	
• Transformer/Battery charger (110-240 V)	
• Carrying strap	
• Probe set	
• 15-pin I/O connector	
• CD Instruction manual	
PHD-4 Replacement Part Kit	Part Number
Includes	9694660
• Sampling pump with fittings	
• Probe with sampling line	
• Tip probe filter	
• Internal filter (kit of 5 units)	
PHD-4 Basic Package	Part Number
Includes	9694600
• PHD-4 basic unit	
• Transformer/Battery charger (110-240 V)	
• Carrying strap	
• 15-pin I/O connector	
• CD Instruction manual	

Accessories	Part Number
• Probe set	9693515
• Capillary leak with refillable reservoir and gauge	9693540
• Probe with 10 meter (30') maximum sampling line	9693525
• Telescoping extension probe	9693520
Individual Replacement Parts	Part Number
• Spare battery	SR 03.702609
• Power supply (110-240 V)	SR 03.702888
• Sampling pump with fittings	SR 03.702513
• Probe with sampling line	SR 03.702538
• Tip probe filter	SR 28.900012-01
• Internal filter (kit of 5 units)	SR 03.702959
• Carrying strap	SR 03.702791
• 15-pin I/O connector	SR 03.702894
• Travel Case (metal)	SR 03.702890
• Protective Bag (canvas)	VSPHD4BAG

Contact Agilent for Rack mounting or specific application requirements.

PHD-4 Features and Benefits



High Sensitivity to Helium – Can detect very small leaks

- High Sensitivity (2 ppm) to helium, three orders of magnitude better than industry standard, due to SIPD (proprietary and patented Selective Ion Pump Detection)
- Excellent selectivity for helium allows you to read helium leaks and ignore all other gases
- Helium sensitivity can be adjusted as required to minimize test costs and helium consumption
- Autozero function allows leak detection even in high helium background environment



Easy to Use – No training required

- State-of-the-art microprocessor control allows great simplicity of operation
- Fully automatic start-up
- Ready for test in less than 3 minutes
- Intuitive touch screen display
- Visual and audio indicators (standard headphone connection)
- No tuning required



Truly Portable – Compact and light

- The PHD-4 weighs only 2.6 kg (5.7 lbs) including the battery
- Its compact size allows it to be easily carried anywhere
- Its ergonomic design allows comfortable use for extended periods



Versatile – Suitable for many different applications

- Wide range of uses: replaces or can be used with existing methods such as bubble test or pressure decay
- Able to detect both very small and large leaks
- Can operate either on battery power or connected to an outlet
- Displayed messages can be viewed in several languages (English, French, German, Italian).
- Standard Analog and RS232 Serial output.



Dependable – Long term operation

- Automatic backflow valve prevents helium saturation ensuring fast response times, as well as long life of sensing element.
- CE, CSA/US approved for global standardization.



Large Vessels and Bioreactors

The PHD-4 offers unmatched accuracy and repeatability, presenting a unique solution that is cost effective and very well suited for the leak range specifications of this application. Biotech and pharmaceutical industries used to rely on pressure decay and bubble test methods for finding leaks in their large bioreactors. The PHD-4 has established a new standard of quality, significantly increasing production yields.

- Fermenters
- Sterilizers
- Freeze Dryers



Underground Pipes and Storage Tanks

The portability and light weight of the PHD-4 plays a major role in this application. Underground pipes and storage tanks (UST) are slightly pressurized with helium which, due to its high mobility, can escape through small leaks and migrate to the surface where it can be easily detected by the PHD-4. The accuracy, portability and light weight of this unit greatly simplifies this process, particularly in difficult construction sites or rough terrain.

- Gas distribution lines
- Under and above ground containers and storage tanks
- Telecommunication and high voltage underground cables



Courtesy of Fraunhofer UMSICHT, Germany

Water Heating and Cooling Pipes

The PHD-4 locates leaks without interruption of the normal operation by mixing helium with the water in the circuit. Until recently, the precise and rapid location of leaks in buried pipes has been very difficult. In the event of a leak, helium desorbs from the fluid and diffuses to the surface where it is easily detected. Leaks in pipeline systems such as district heating systems, drinking or chilled water systems and steam pipe networks incur high costs due to losses and corrosion damage.

- Heater exchangers and steam condensation lines
- Water pipes
- Radiant heating systems



Airplane Fuel Tanks and Lines

PHD-4 technology is approved worldwide by airplane manufacturers and operators as the standard for the location of leaks in aircraft fuel tanks and in oxygen distribution lines. For this purpose, helium is injected from the outside into the tank to be checked and the helium probe is used inside the wings to locate any leaks.

- Fuel tanks
- Oxygen distribution lines

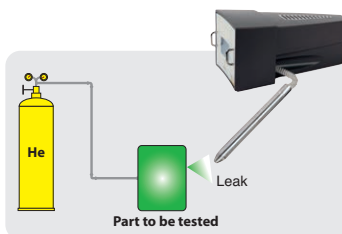

Other Applications

The PHD-4 is in daily use in many other applications. Virtually any object requiring any level of leak tightness can be simply tested with this instrument. Here is a partial list of other applications:

- Components and systems for the Chemical and Petrochemical Industries
- Components for the Automotive industry
- Process gas delivery lines in Semiconductor fabrication industry

Agilent Pumps Designed for Leak Detection

Agilent has the advantage of being a designer and manufacturer of both vacuum pumps and leak detectors. This gives us the proper insight for designing pumps that are perfectly suited for use in leak detection applications.

DS Series Rotary Vane Pumps

Leak detectors require pumps with the ability to quickly pump out the test piece while efficiently pumping and expelling helium from the system. Failure to do so limits leak detector performance. DS series pumps fulfill all the rigorous requirements of use in leak detection while delivering quiet, cool-running and dependable performance. DS Series Pumps:

- provide excellent helium pumping characteristics for stable leak rate signals
- employ forced oil-feed to remain cool even when pumping large volumes
- feature an anti-suck back valve to prevent migration of pump oil toward the leak detector

For technical information on rotary vane pumps, refer to Agilent's Dual Stage Rotary Vane Pump catalog.

Rotary Vane Pump – Outline Drawing

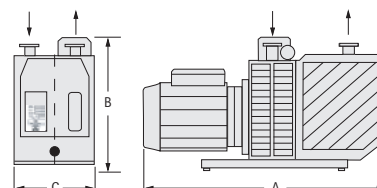

Pump	Pump Speed	A (length)	B (height)	C (width)
DS 42	60 Hz 1.2 cfm	309 (12.0)	192 (7.5)	108 (4.2)
	50 Hz 1.8 m ³ /hr			
DS 302	60 Hz 8.2 cfm	467 (18.4)	212 (8.3)	132 (5.2)
	50 Hz 11.6 m ³ /hr			

TriScroll Series Dry Scroll Pumps

For many applications, "dry" pumping is essential. In the past, dry pumps have had either low pumping speeds, poor base pressure, or both. Agilent's TriScroll series pumps have revolutionized dry leak detection. With special design considerations implemented specifically for helium mass spectrometer leak detection, our dry pumps conform to rigorous standards without the potential for contamination.

TriScroll pumps:

- provide high speeds for fast evacuation and cycle time
- deliver low base pressure for high sensitivity testing
- use no oil, avoiding contamination and oil disposal
- are optimized for helium pumping

For technical information on scroll pumps, refer to Agilent's Dry Scroll Pump catalog.

TriScroll Pump – Outline Drawing

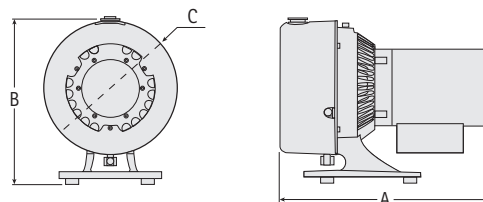

Pump	Pump Speed	A (length)	B (height)	C (width)
TriScroll 620	60 Hz 17.7 cfm	471 (18.54)	355 (13.98)	300 (11.8)
	50 Hz 25.2 m ³ /hr			

MacroTorr Turbo and Turbo/drag pumps

The high vacuum pump in a mass spectrometer system is critical to a well-designed leak detector. These pumps need to deliver high pumping speed to keep the spectrometer tube at low pressure, while offering the correct helium compression ratios to allow for high sensitivity. In addition to offering all of the appropriate pumping characteristics, Agilent's patented MacroTorr turbo and turbo/drag pumps require no periodic maintenance.

- MacroTorr design provides high inlet pressure tolerance
- optimized helium compression ratio permits optimal helium detection and fast signal clean-up
- permanently lubricated bearings need no maintenance

For technical information on turbo pumps, refer to Agilent's Turbo Pump catalog.

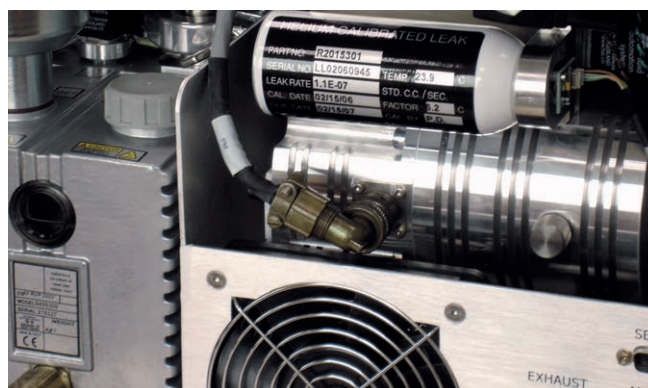

Calibrated Helium Leaks

Agilent offers helium leaks traceable to NIST standards for use in calibrating your leak detector. An NW25 or 1 1/8" OD tube fitting and isolation valve are provided as standard on the external leaks. The 10⁻⁶/10⁻⁵ range reference helium leak includes a pressure gauge and refill port for evacuation and sniff test calibration.

External

NW25	1 1/8" Compression Port	
F8473325	F8473320	10 ⁻⁶ /10 ⁻⁵ std cc/sec range refillable sniffing/evacuation leak with pressure gauge and KF25 adapter
F8473321	F8473301	10 ⁻⁷ std cc/sec range, with valve
F8473322	F8473302	10 ⁻⁸ std cc/sec range, with valve
F8473323	F8473303	10 ⁻⁹ std cc/sec range, with valve
F8473324	F8473304	10 ⁻¹⁰ std cc/sec range, with valve

Internal, 1/8" NPT Fitting (without valve)

K3264301	10 ⁻⁷ std cc/sec range
K3264302	10 ⁻⁸ std cc/sec range

Calibration

Calibration of existing leaks is done on an advance exchange basis. To order the recalibration service, simply add "GG" in front of the above part numbers.

Gas Line Testing Accessory

The gas line testing accessory allows fast response evacuation leak detection of long (>30') gas lines. It is comprised of a male VCR (Cajon 4) cross with needle type purge flow valve and 10⁻⁹ atm cc/sec range calibrated leak. A pressure transducer is optional.

MSPA6415

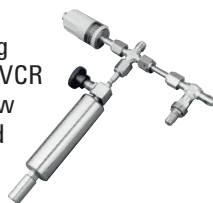

Helium Lecture Bottle Kit

The Helium Lecture bottle provides a convenient supply of helium for leak testing. Measuring only 14" long and 2 1/2" diameter, the bottle will provide enough helium for a full eight hours of leak testing at normal flow rates. The kit includes a Helium Lecture bottle containing 2 cubic feet of helium at 1800 psi, a pressure and flow regulator (P/N 642972175), and a helium spray probe kit (P/N K0167301) in one package.

L8856301



Helium Spray Probe Kit

K0167301

For use in spraying helium to find the exact location of a leak. Three nozzles are included: a hypodermic nozzle for pinpointing leaks, a flexible tubing nozzle for hard-to-reach areas, and a long, soft copper nozzle that can be bent into almost any configuration to reach into deep crevices. An easy operating spring handle and 10 feet of hose with a female fitting simplifies attachment to the helium regulator.



Leak Detection Handbook

699909070

The 135-page handbook, *Introduction to Helium Mass Spectrometer Leak Detection*, is useful for experts and novices. It covers leak detection fundamentals, helium leak detector types, equipment calibration, and product fixture design. A wide variety of process-specific application solution notes is also available.

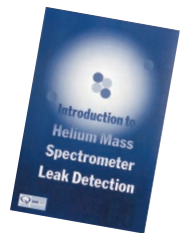

Leak Detection Service Contracts

Agilent offers a full range of preventive maintenance and comprehensive on-site support options for all of our leak detectors. See page 26.

Leak Test Data Wizard

VS LTDW

The Leak Test Data Wizard is a comprehensive data management software package for use with our VS Series leak detectors. It is a flexible PC based, graphic-rich tool that makes full use of the data from the VS leak detector to customize automation of basic leak test processes, assuring testing uniformity over time or between operators.



See page 9.

Accessories and Options

Training Programs

Training courses for leak detector operation and maintenance are offered in regularly scheduled classes at our Palo Alto, California or Lexington, Massachusetts facilities. On-site training can also be provided at your plant. Contact your local sales engineer or see the training and service sections of this catalog.

See worldwide service and support on page 26.

See Leak Detector Training Programs on pages 28 and 29.

PHD-4 Bag

The Power Probe is a "sniffer" probe designed to locate leaks emanating from sealed containers internally pressurized with helium. The Power Probe adjusts for varying sensitivity and response time. It is extremely rugged and can be easily disassembled for cleaning.



Power Probe

K9565301	Power Probe with 1/8" Test Port Adapter, 10' length
K9565302	Power Probe with 1/8" Test Port Adapter, 25' length
K9565306	Power Probe with KF25 Flange, 10' length
K9565307	Power Probe with KF25 Flange, 25' length
K9565303	Spare Tip Filters (10 each)

The Power Probe is a "sniffer" probe designed to locate leaks emanating from sealed containers internally pressurized with helium. The Power Probe adjusts for varying sensitivity and response time. It is extremely rugged and can be easily disassembled for cleaning. The probe kit includes 5 tip filters and is available with 10 or 25 feet of connecting tubing and an inlet adapter to fit on the leak detector. It is ideal for fast response sniffing with MacroTorr pumped leak detectors.



Spectrometer Tube Cleaning Kit

670029096

Kit with pre-saturated wipes and swabs
This Cleaning Kit contains clean wipes pre-saturated with Dow-Corning OS-20 solvent plus cotton swabs for cleaning in small holes or corners. The kit is adequate for three spectrometer cleanings and can also be used for a variety of other vacuum applications.



Test Port Adapters and Kits

L8741301	1/8" Test Port to NW25 nipple adapter
L8741302	1/8" Test Port to NW40 nipple adapter
KCP401125	Adapter from NW40 to 1/8" compression fitting
LDCOMPINADKIT	Test Port Adapter Kit, to 1/8" compression fitting
LDNW25INADKIT	Test Port Adapter Kit, to NW25 fitting

Test Port Extension Manifold On request

K9799303

The Test Port Extension Manifold provides a 1" (28 mm) ID quick coupling port on both the left side and the right side of the 947/948 or 960 leak detector. The standard test port is still available for use with the extension manifold attached.

Throttle Valve, for 1/8" Compression Port

626603345

The Agilent throttle valve is a manually operated, NW25 to 11/8" tubulated variable conductance device used to control the flow of gas to the leak detector. It is frequently used in leak detector applications in which a grossly leaking part or vacuum chamber will not permit the leak detector to go into the test mode. The throttle valve is a non-quantitative approach to locating very large leaks in your vacuum system.

Tuning Leak, for 1/8" Compression Port

K1608301

The Tuning Leak consists of a ten-segment calibrated needle valve which can be used as an aid to gross leak testing or for gross leak calibration. The Tuning Leak can be used with any Agilent Leak Detector and can also provide an indication of background helium in the testing area.



Throttle/Tuning Leak Valve with NW25 Fitting

R1947301

For leak detectors with an NW25 inlet, the tuning leak and throttle valves have been combined into one product. This valve performs the same functions as the two described above.



Leak Detection

Universal Test Fixture Option (Flapper Box)

L6241301	947/948 Series, 1½" Compression Port
L6241305	979 Series, 1½" Compression Port
L6241306	979 Series, NW25

This leak detector option makes leak testing of small parts almost totally automatic and very fast. With this option, the total time to test a typical integrated circuit or other small device is less than six seconds. The fixture is clamshell-shaped with tapered walls and a spring-loaded lid. The fixture can be used with the Automatic Sequencer feature in Models 947/948/960 or 979 in order to fully automate and quicken the test cycle. Size: 4" ID x 1" deep. An insert is supplied to reduce the size to 3.25" ID, tapered to 2.83" x ¾" deep.

Probe Set, PHD-4 9693515

This set consists of three different probe tips that can replace the standard tip for specific applications. One tip has a smaller diameter for more precise leak location. A second is more flexible, for easy access to difficult areas, and a third is for general use.

Capillary Leak with Refillable Reservoir, PHD-4 9693540

This capillary leak is useful to monitor proper operation of the PHD-4, ensuring that it is sensitive to helium at all times. The probe tip can be simply inserted in the capillary outlet and a signal of given value is displayed on the front panel. The helium reservoir can be refilled from a helium source.

Probe with 10 m (30') Sampling Line, PHD-4 9693525

For applications in which the length of the standard probe is not adequate, a probe extension is available. It has a maximum length of 10 m, but may be cut to shorter lengths.

Telescoping Extension Probe, PHD-4 9693520

This probe assists the operator when additional rigid length is required, as when checking underground objects, or objects beyond arms length. The tip has a small funnel to better convey helium to the probe.

Accessories and Options

Ordering Information

Description	Part Number	VS	PHD-4	979	959	947/948	960	990
Atmospheric gross leak option for 947/948	L6839301					•		
Collector assembly for 947/948 and 960	K9740301					•	•	
External calibrated helium refillable leak, 1½" comp., 10 ⁻⁶ /10 ⁻⁵ std cc/sec	F8473320	•		•	•	•	•	•
External calibrated helium refillable leak, NW25, 10 ⁻⁶ /10 ⁻⁵ atm cc/sec	F8473325	•		•	•	•	•	•
External calibrated helium leak, 1½" comp., 10 ⁻⁷ atm cc/sec	F8473301	•		•	•	•	•	•
External calibrated helium leak, NW25, 10 ⁻⁷ atm cc/sec	F8473321	•		•	•	•	•	•
External calibrated helium leak, 1½" comp., 10 ⁻⁸ atm cc/sec	F8473302	•		•	•	•	•	•
External calibrated helium leak, NW25, 10 ⁻⁸ atm cc/sec	F8473322	•		•	•	•	•	•
External calibrated helium leak, 1½" comp., 10 ⁻⁹ atm cc/sec	F8473303	•		•	•	•	•	
External calibrated helium leak, NW25, 10 ⁻⁹ atm cc/sec	F8473323	•		•	•	•	•	•
External calibrated helium leak, 1½" comp., 10 ⁻¹⁰ atm cc/sec	F8473304	•		•				
External calibrated helium leak, NW25, 10 ⁻¹⁰ atm cc/sec	F8473324	•		•			•	
Fast Sniff Tester – external attachment, 115 V, 1½" compression port	L6539301				•	•		
Gas line testing accessory	MSPA6415			•	•	•		•
Handbook of Leak Detection	699909070			•	•	•	•	•
Helium lecture bottle with regulator and spray probe kit	L8856301			•	•	•	•	
Helium spray probe (order regulator separately)	K0167301			•	•	•	•	
Internal calibrated leak, 10 ⁻⁷ atm cc/sec range	K3264301			•		•		
Internal calibrated leak, 10 ⁻⁸ atm cc/sec range	K3264302			•		•	•	
Ion source, thoriated iridium (new)	82850302			•	•	•	•	•
Ion source, thoriated iridium (rebuilt)	GG82850302			•	•	•	•	
Ion source, tungsten (new)	82850301				•			
Ion source, tungsten (rebuilt)	GG82850301				•			
O-Ring Kit for 979	R0491301			•				
O-Ring Kit for 947/948/960	L5669801					•	•	
O-Ring Kit for 959 DP	L6749301				•			
O-Ring Kit for 959 Turbo	L6930301				•			
O-Ring Kit for 956 DP	9569901							
O-Ring Kit for 956 Turbo	9569905							
O-Ring Kit for 990 Valve Block	L9346301							•
O-Ring Kit for 938-41	K7641801							
O-Ring Kit for 936 Series	K4372801							
O-Ring Kit for 947/948/960 DP	L5669801				•	•		
Power probe sniff accessory – 1½" fitting, 10'	K9565301			•	•	•	•	
Test port nipple, NW25 on 1½" OD Tube	L8741301			•	•	•	•	
Test port nipple, NW40 on 1½" OD Tube	L8741302			•	•	•	•	
Test port adapter kit, 11/8 compression fitting	LDCOMPINADKIT			•	•			
Test port adapter kit, NW25 fitting	LDNW25INADKIT			•	•			
Power probe sniff accessory – 1½" fitting, 25'	K9565302			•	•	•	•	

Leak Detection

Ordering Information

Description	Part Number	VS	PHD-4	979	959	947/948	960	990
Power probe sniff accessory – KF25 fitting, 10'	K9565306			•	•			•
Power probe sniff accessory – KF25 fitting, 25'	K9565307			•	•			
Preamplifier assembly – 959 (Turbo), 938-41, 936 series	K3333301			•		•		
Preamplifier assembly – 959 (MacroTorr) and 990	L9030301							•
Preamplifier board – 947/948 and 960	K9765301					•	•	
Preamplifier assembly – 979 standard sensitivity	L9030301			•		•	•	
Preamplifier assembly – 979 High sensitivity	R1003301			•				
Remote module for 947/948/979 (new platform)	L9558301			•		•	•	
Remote module for 947/948/960 (old electronics)	L9558302			•		•	•	
Spectrometer tube cleaning kit	670029096			•	•	•	•	•
Test port O-Ring (2-216)	660892216							
Test port conversion Kit, 1½" test port to NW25	L8741301			•	•	•	•	
Test port conversion Kit, 1½" test port to NW40	L8741302			•	•	•	•	
Test port extension manifold*	K9799303					•	•	
Tip filters for power probe sniffer (10 each)	K9565303				•			
Throttle valve	626603345			•	•	•	•	
Valve block, basic unit, 990 series	L9085301							•
Valve block, complete, standard version, 990 series	L9085302							•
Valve block, complete, stainless version, 990 series	L9085303							•
Probe set	9693515		•					
Capillary leak with refillable reservoir	9693540		•					
Probe with 10 m (30') sampling line	9693525		•					
Telescoping extension probe	9693520		•					
Oil mist eliminator for internal DS 42	VSFACME	•						
1½" compression test port	VSFLDCP	•						

* Factory-installed option only

For further information, contact our technical support staff.

Agilent Global Support Network

Our Customer Service mandate is to provide you with the level of support necessary to increase your productivity, maximize your system uptime, and achieve the highest possible return on your investment.



AgilentCare

In order to maximize your system uptime and extend the value of your investment, we offer a complete range of support programs that meet all your needs.

TotalCare

Comprehensive support ensures continuous high performance operation including RemoteCare, Agilent's unique remote diagnostic support capability.

PreCare

Extend the life of your leak detector and protect your initial investment with regularly scheduled preventative maintenance support (PMs).
Optimize system operation with basic cleaning and retune.
Establish and maintain clear audit trails for ISO and other quality standard requirements.

AdvancedCare

Guarantee uninterrupted system operation with advanced exchange inventory – available to meet the most time critical applications.
Extended support available beyond basic factory warranty.
Factory and field corrective maintenance support for rapid repair and quick turnaround of equipment.

And more...

We offer special customer defined services not offered in standard agreements.
Maximize equipment performance with training courses, on-site training and leak detection technology/application seminars.

Agilent RemoteCare

To meet the stringent uptime demand of today's business environment, Agilent has developed RemoteCare, a unique remote diagnostic program utilizing the vast capabilities of our VS Leak Detectors.

Our factory technical experts are able to connect to your VS Leak Detector at your site and perform analysis for proactive system reviews or rapid problem resolution.



Leak Rate Test & Measurement



Course Description

Leak Rate Test and Measurement provides a comprehensive introduction to production testing of parts against leak-rate specifications, and measuring and locating leaks in pressurized systems/components, using popular Helium Mass Spectrometer Leak Detectors (HMSLDs) and various application test fixtures.

The 2-Day Stand-Alone course presents principles of operation of the spectrometer and underlying vacuum fundamentals

in a classroom setting. Operation, tuning, and calibration of the leak detector are covered in practical demonstration/laboratory sessions. Leak testing methods designed to solve various problems are discussed and demonstrated.

The 1-Day Companion course builds on the vacuum and Helium Mass Spectrometer Leak Detector (HMSLD) fundamentals learned in BVP, and provides an introduction to production testing of parts against leak-rate specifications, and measuring and locating leaks in pressurized systems/components, using an HMSLD. Leak testing methods designed to solve various problems are discussed and demonstrated.

Who Should Attend?

Engineers and operators who are responsible for quality control of production parts and assemblies. Also, technicians responsible for the maintenance of pressurized and evacuated systems such as those found in power generation facilities, process gas delivery, and refrigeration, etc

Course Goals and Objectives

After completing this course, participants will be able to:

- Identify advantages and disadvantages of various leak testing methods
- Describe rate-leak specifications and helium conversions.
- Select, setup, and perform the proper leak test technique for a given application

Students who take the 2-Day Stand-alone course will be able to:

- Explain vacuum fundamentals and concepts essential to the operation of an HMSLD
- Describe principles of operation of a mass spectrometer
- Properly operate, tune, and calibrate an HMSLD

Course Outline

Stand Alone (LRTM-SA)

2 Days

Basic Vacuum Practice is the required prerequisite and scheduled to immediately precede LRTM-BC.

Day 1

- Introduction to Leak Detection
- Vacuum Fundamentals for Leak Detection
- Introduction to Rough Vacuum Systems
- Introduction to High Vacuum Systems
- Helium Leak Detector Fundamentals
- *Demo LAB:* Tuning, zeroing, and calibration

Day 2

- HMSLD performance considerations
- Leak-Rate Specification Conversions
- Locating Leaks
- Measuring Leak Rate
- *Demo LAB:* Measure leak rates
- Application-Specific Leak-Rate Testing examples
 - Hermetically sealed parts
 - Pressurized parts: accumulation method
 - Pre-pressurized parts in large vacuum chamber
 - Parts with pressure-differential intolerance
 - Small part/high sensitivity
 - Long narrow tubes
 - Process gas
 - Components and systems

Course Outline - BVP-Companion (LRTM-BC)

1 Day

Basic Vacuum Practice is the required prerequisite and scheduled to immediately precede LRTM-BC.

- Introduction to Leak Detection
- Leak-Rate Specification Conversions
- Locating Leaks
 - *Demo LAB:* Find leaks in evacuated & pressurized parts
- Measuring Leak Rate
 - *Demo LAB:* – Measure leak rates
- Application-Specific Leak-Rate Testing examples
 - Hermetically sealed parts
 - Pressurized parts: accumulation method (joints/welds/ crimps, AC lines, brake lines, valves)
 - Pre-pressurized parts in large vacuum chamber (compressor, heater core, wheel, gas tank, transmission, torque converter)
 - Parts with pressure-differential intolerance (gas tanks, gas caps, filler necks)
 - Small part/high sensitivity
 - Long narrow tubes
 - Process gas components and systems

Leak Detection

Leak Detector Maintenance (LDM)

3 Days



Course Description

This course provides participants with the ability to perform routine maintenance and troubleshooting procedures on supported Agilent Leak Detectors. Scheduled training is available for the following Agilent models: 959, 979, and VS. Training for other Agilent LD models is available through our On-Site Training program. This course begins with an introduction to leak detection and vacuum fundamentals then moves on to cover the principles of operation of the spectrometer and the underlying vacuum system in a classroom setting. Operation, tuning, and calibration of the leak detector, as well as preventative maintenance and troubleshooting procedures, are covered in practical laboratory sessions.

Lab equipment, including Agilent leak detectors and various maintenance consumables, is provided for extensive hands-on lab activities and instructor-led demonstrations. Participants will work with the Agilent leak detector model that they use in their work environment.

Who Should Attend?

This course is for maintenance technicians and personnel responsible for maintaining Agilent leak detectors.

Course Goals and Objectives

After completing this course, participants will be able to:

- Explain vacuum fundamentals and concepts essential to the operation of a leak detector
- Describe principles of operation of a helium mass spectrometer and ContraFlow
- Identify all major LD components
- Properly operate, tune, and calibrate the LD
- Perform preventative maintenance procedures:
 - Spectrometer cleaning and seal replacement
 - Ion Source replacement
 - Valve blocks and manifold cleaning
 - Mechanical and high vacuum pumps
 - Troubleshoot routine problems

Course Outline

Day 1

- Introduction to Leak Detection
- Overview of Vacuum for Leak Detectors
- Introduction to Rough Vacuum Systems
 - *Hands-On LAB*: Roughing pump-down
- Introduction to High Vacuum Systems
- Leak Detector Fundamentals
 - *Hands-On LAB*: ID system components

Day 2

- Operation of the Leak Detector
- Spectrometer Tuning, Zeroing, and Calibration
- Spectrometer Maintenance Procedures
 - *Hands-On LAB*: Clean spectrometer and replace Ion source
- System Electronics
 - *Hands-On LAB*: ID components and verify test point data
- Gauge Maintenance
 - *Hands-On LAB*: Calibrate test port and system gauge

Day 3

- Valve Block and Manifold Maintenance
 - *Hands-On LAB*: Clean valve block and manifold
- Mechanical Pump Maintenance
 - *Hands-On LAB*: RV/TS pump maintenance
- High Vacuum Pump Maintenance Procedures
 - *Hands-On LAB*: DP/TP pump maintenance
- System Troubleshooting
 - *Hands-On LAB*: Troubleshoot common problems

Advantages of Helium Leak Detection

Why Helium Leak Detection?

Helium is a superior choice of tracer gas used to find leaks for a multitude of reasons. Helium is:

- Non-toxic
- Inert and non-condensable
- Normally not present in the atmosphere at more than trace amounts
- Relatively inexpensive
- Readily passes through leaks due to its small atomic size
- Non-flammable
- Available in various size cylinders
- Available in purities appropriate for medical usage

The only molecule smaller than helium (mass 4) is hydrogen (mass 2), which is not inert. Helium is much lighter than the next heavier inert molecule, neon (mass 20) which is much more expensive. Helium is present at a concentration of only 5 ppm in normal atmospheric conditions.

Other Leak Test Methods Often Fall Short

There are many other methods of leak testing but none that can match the ability of helium leak testing to locate and quantify leaks (Figure 1).

Acoustic Leak Detection uses sonic or ultrasonic energy that is generated by a gas as it expands through an orifice. This method is fairly simple and fast but is only sensitive to 10^{-3} atm cc/second.

Bubble Testing is a common method of leak detection in industry today. It can be as simple as pressurizing a part, placing it under water, and looking for leaks. It can also be done by pressurizing the part with air, applying a soapy solution, and looking for bubbles. This method is simple and cost effective for locating large leaks but also has its drawbacks. The test piece gets wet and may therefore need drying. It also cannot measure total leakage rates and is only useful for 10^{-4} atm cc/second leaks and larger.

Pressure Decay is commonly used in plumbing and many other industries. It may only involve a compressor and a pressure gauge, though some systems can be much more complex and expensive. The sensitivity of this method is proportional to time but generally limited to 10^{-4} atm cc/second. Another problem with this method is that fluctuations in temperature degrade the accuracy of the tests.

Halogen Gas Detection is commonly used in the air conditioning and cooling industry. This technology uses an infrared type detector to detect the presence of halogen tracer gas. This requires the test piece to be charged with Halogen, which is impractical, expensive, and can be an environmental issue.

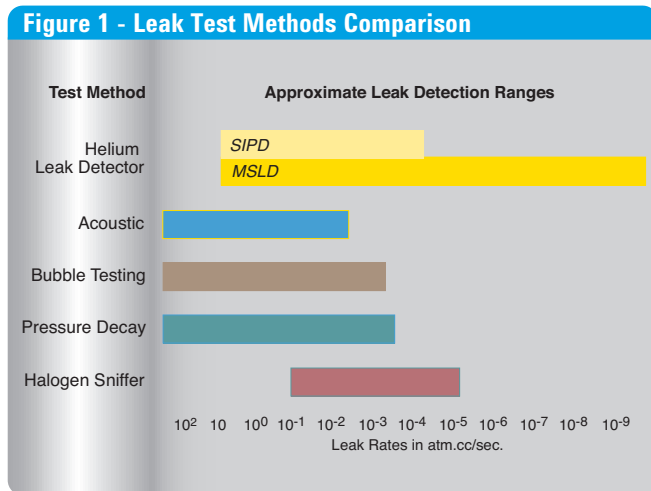

Leak Detection

Agilent's Helium Leak Detection Technologies

A Mass Spectrometer Leak Detector (**MSLD**) is a complete system for locating and/or measuring the size of leaks into or out of a device or a container. This method of leak detection is initiated when a tracer gas, helium, is introduced to a test part that is connected to the MSLD system. The helium leaking

from the test part diffuses through the system, its partial pressure is measured, and results are displayed.

The MSLD operating principle consists of ionization of the gases in a vacuum and their acceleration across a voltage drop and a magnetic field (Figure 2). The helium ions are separated and collected, and the resulting ion current is amplified and indicated on the display.

A mass spectrometer leak detector consists of the following components:

- A spectrometer tuned to detect helium
- A vacuum system to maintain adequately low pressure in the spectrometer
- Primary pumps to evacuate the part to be tested
- Valves that enable the various stages of the leak detection cycle, from evacuation, to test, to venting
- Amplifier and readout instrumentation that monitors spectrometer output signal
- Electrical power supplies and controls that sequence valve's, protective circuits, etc.
- Fixturing that attaches the part to be leak-tested to the leak testing equipment

Figure 2 - Mass Spectrometer Tube Schematic

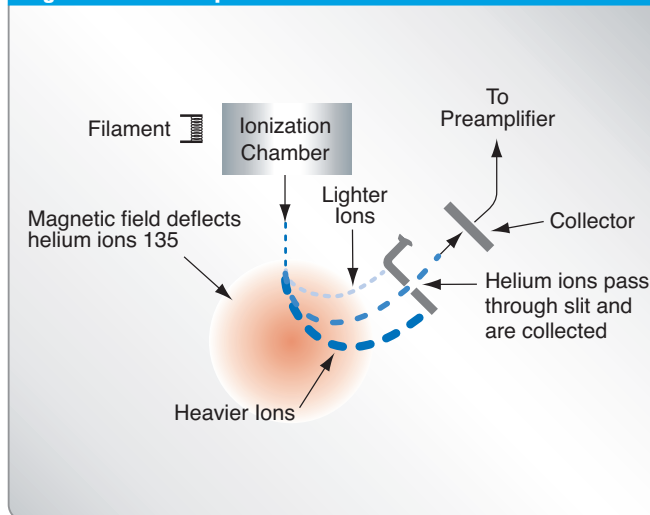

The PHD-4 Portable Helium Detector is also sensitive to helium and is based on a patented technology called Selective Ion Pump Detection (**SIPD**) (Figure 3). The sensor technology incorporates an ion pump connected to a quartz capillary tube and maintained under high vacuum. This membrane is heated with a coiled platinum filament. Once heated, the membrane becomes permeable to helium. As the partial pressure of helium in the ion pump increases, so does the current draw of the ion pump. This current is proportional to the pressure and is therefore representative of the helium at the test probe of the PHD-4.

A selective ion pump detector consists of the following:

- An ion pump and controller
- A permeable quartz capillary
- A heater coil that surrounds the quartz capillary
- Electronics to process the signal
- Display for access to leak rate and other unit functions

Figure 3 - Selective Ion Pump Detector

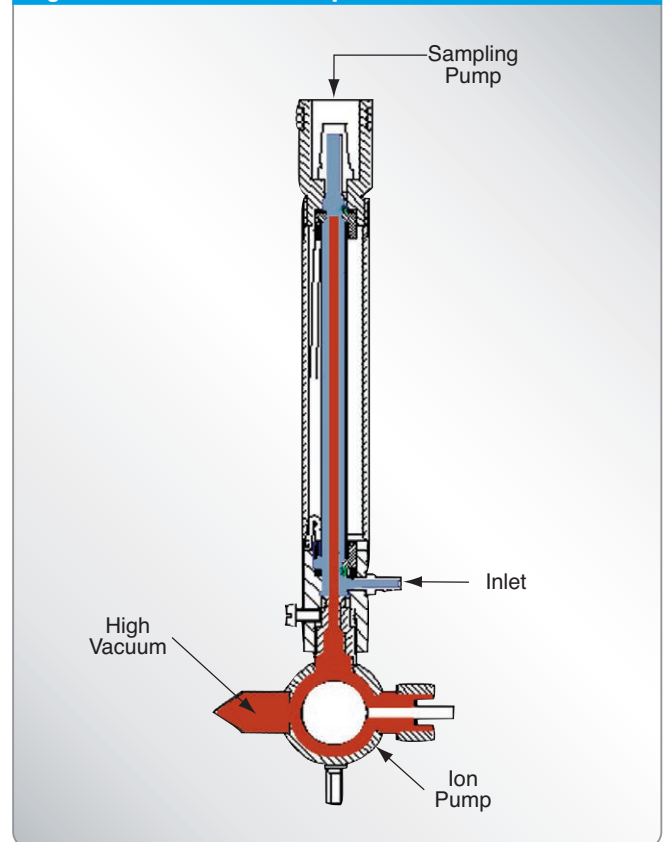

Leak Detection Methods

Methods of Leak Testing

There are many different ways to leak test parts using helium as a tracer gas. In general, the leak detection method is selected based on the actual working conditions of the part being tested. It is recommended that during leak testing, the same pressure differential be maintained and in the same "direction" as exists during the actual use of the part. For example, a vacuum system is tested with a vacuum inside the chamber, while a compressed air cylinder should be tested with a high pressure inside the cylinder.

There are also two general concerns when leak testing. One is the location of leaks and the other is the measurement of the total leakage rate of the part, as some leakage may be acceptable. In many cases, parts may be first tested to determine if they pass an acceptable level, and if not, the part may be taken off line and subjected to a second test with the intent of locating the leak. Additionally, many parts may be tested in batches. If a batch fails, the individual parts in that batch may then be tested separately to identify the leaking part(s).

Vacuum Testing Method (Outside-in)

The part to be tested is evacuated with a separate pumping system for large volumes, or with just the leak detector itself. When the appropriate cross over pressure has been reached, the leak detector is valved-in or transfers into test and the part is tested using one of the following methods:

Locating Leaks (Figure 1)

To pinpoint the location of the leak(s) (but not measure the total leakage rate), helium is administered to the suspected leak sites of the part using a spray probe with an adjustable flow.

Figure 1 - Locating Leaks – Outside-in

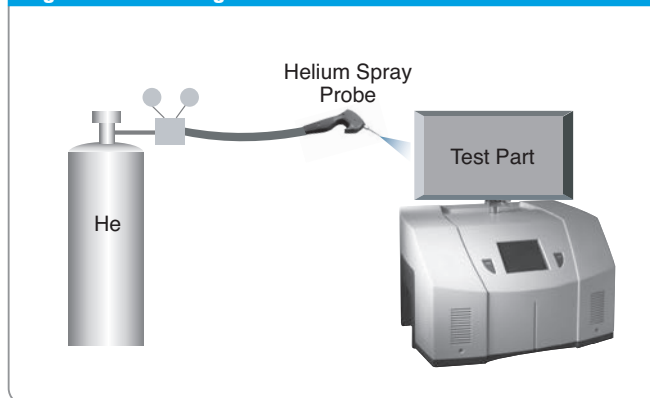

Measuring Leaks (Figure 2)

To determine the total quantity of leakage (but not the number or location of leaks), the part is connected to the leak detector and shrouded by a helium environment. This helium environment can be contained in many methods ranging from a simple plastic bag to more complex bell jar arrangements.

Figure 2 - Measuring Leaks – Outside-In

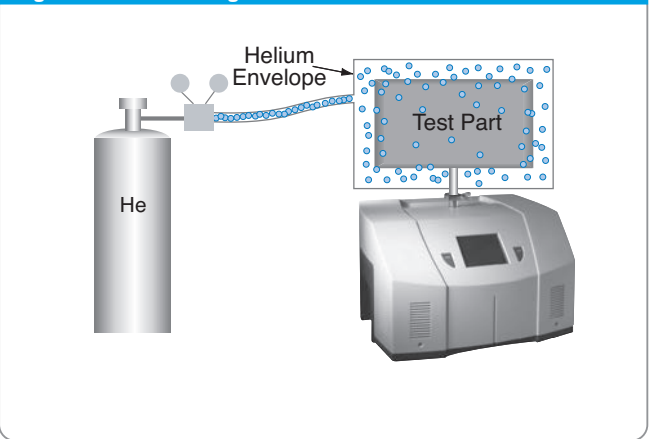

Pressure Testing Method (Inside-out)

In this technique, the part is pressurized with helium or a mixture of helium and air, and tested by one of the following methods:

Measuring Leaks (Figure 3)

To determine the total quantity of leakage (but not the number or location of leaks), the part is pressurized with helium (or a mixture of helium and air or nitrogen). This can be done by bombing or backfilling small hermetically sealed parts. Larger parts can be actively pressurized using a hose or tubing to deliver the helium. The part is placed in a volume that is then evacuated by the leak detector. All the helium escaping from the part is captured and quantified.

Figure 3 - Measuring Leaks Inside-out

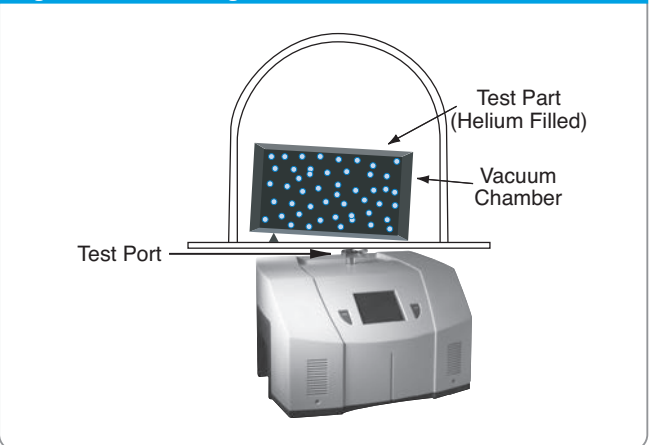

Leak Detection

Locating Leaks (Figure 4)

To pinpoint the location of the leak(s) (but not measure the total leakage), the likely potential leak sites of the part are scanned using a Sniffer Probe connected to the inlet of the leak detector.

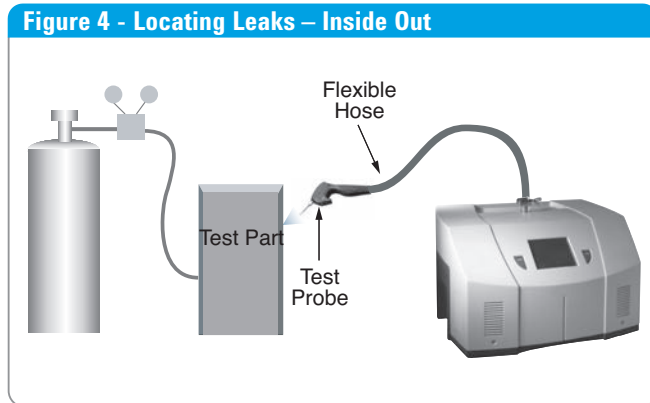

Accumulation Testing Method (Figure 5)

This method can both locate and quantify leaks. Some type of shroud or hood is placed in such a manner as to envelop a potential leak site. A certain amount of time is given to allow leaking helium to accumulate in the shrouded area, increasing the helium concentration. The leak detector is then valved-in to the shrouded volume. If many potential leak sites exist in a manifold or if many parts are to be tested at the same time, they can be sequentially valved-in to determine which site is leaking.

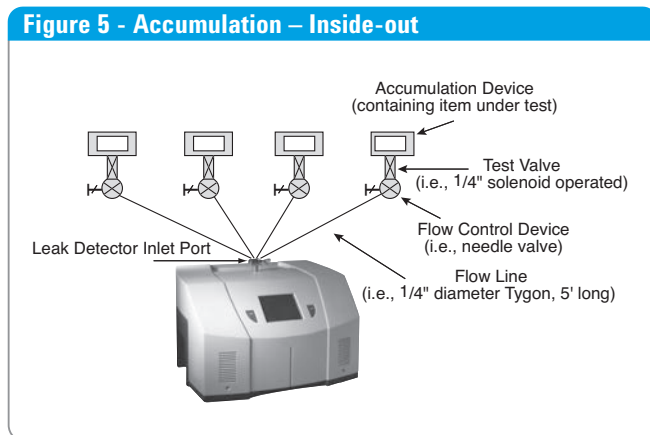

System Leak Test Methods

Systems, like individual parts, should be tested with the same pressure differential and in the same direction as in actual use. Therefore, systems that are under vacuum while in operation should be leak tested under vacuum, while pressurized systems should be charged with helium to a pressure similar to operational conditions when possible.

Vacuum Systems (Figure 6)

In general, vacuum systems are tested with a portable leak detector. Typically the leak detector is connected by means of a "tee" connected in between the foreline of the high vacuum pump and the inlet of its backing pump. A system should be capable of maintaining a foreline pressure low enough to operate the leak detector at this location. Helium is supplied to potential leak site using a spray probe or "bagging" suspected areas. If a leak exists, helium will enter the system and rapidly diffuse through it. The leak detector should respond within several seconds or less. Note that leak detector sensitivity will be diminished in systems with large backing pumps. If a system is using a cryopump as a high vacuum pump, it must be valved off before helium is introduced as cryopumps have limited helium pumping capacity.

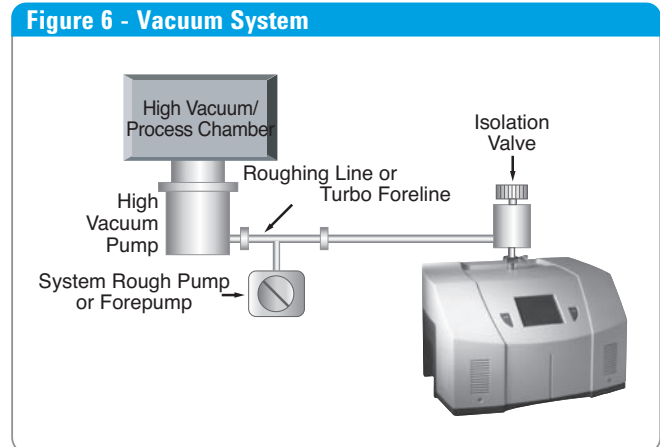

Pressurized systems

Many different types of pressurized systems also need to be leak-free. These systems can be charged with helium or some mixture of helium and another gas such as nitrogen. If a diluted helium mixture is used, the helium signal will be diminished proportionally. For example, if a mixture of 10% helium and 90% nitrogen is used, the signal will read 10% of the actual value of the leak, or a decade lower. This may be acceptable in many cases as system leak checking is usually to locate rather than quantify leaks. Once the system has been charged with an appropriate amount of helium, leak checking can be performed by means of a sniffer probe, or by "bagging" suspected leak sites so that leaking helium will accumulate to a detectable level.

Typical Leak Detection Applications



Maintenance of Systems

Many vacuum process tools in fabs of all types require occasional leak checking. This may be part of a preventative maintenance schedule or in the event of an unexpected failure. Downtime in either case must be minimized. A rugged, dependable, fast starting leak detector is essential to maximize up time of production tools. Agilent VS Series, 959, and PHD-4 portable leak detectors keep industry moving. Examples of some of these applications are:

Vacuum process equipment or tools

- Vacuum furnaces
- Vacuum coaters
- Beam lines
- Electron beam and ion beam process equipment
- Analytical Instruments
- Semiconductor process tools
- Laser process equipment

Pressurized systems

- Power Plants
- Underground tanks, cables, and pipes
- High purity gas handling systems
- Bioreactors and fermenters
- Liquid gas manufacturing facilities
- Fuel tanks and bladders

Quality Control of Production Parts and Assemblies

The detection and location of leaks is critical in the production of many products from individual components, to sub-assemblies, to completed systems. In many of these cases, it is as important to know the size or rate of the leak as it is the location. Whether quantitative or qualitative testing is required, our leak detectors help assure the leak integrity of your parts or assemblies. Some examples include:

Evacuated parts and assemblies

- Hermetically sealed electronic packages
- Valves and manifolding
- Feedthroughs/glass-to-metal seals
- Vacuum vessels and systems

Pressurized parts and assemblies

- Air conditioning and refrigeration assemblies
- Radiators, heat exchangers, and condensers
- Brake, fuel, and hydraulic lines
- Gas tanks
- Food storage tanks and packaging
- Body implantable medical devices
- High purity piping

System Integrated Leak Detection

Manufacturers of large, complex systems may choose to integrate into those systems a component leak detector that can facilitate the on-going maintenance of leak-free integrity, thereby providing additional value to their customers. The Agilent VS C15 Component Leak Detector provides the necessary elements for flexible integration of leak detection capability into a large system. Examples of these systems are:

- Semiconductor process equipment
- PVD/CVD equipment
- E-beam and ion beam processing equipment

Leak Detection



Small, compact, self-contained footprint inside your system.

Mass Produced Parts

Some manufacturing processes require the integration of a leak checking device into a multi-step process, usually with very high production rates. Component leak detectors are designed specifically for these applications in which a vacuum system and the control electronics may be mounted separately. The Agilent VS C15 offers the ultimate flexibility in a helium mass spectrometer leak detection system. The flexibility, ruggedness and rapid response time of these units allows for accurate, repeatable, high volume leak testing in demanding production environments. Some examples include:

High Volume Manufactured Parts

- Automotive fuel systems
- Automotive brake components
- Cooling and refrigeration system components
- Medical devices
- Automotive airbag components
- Tire and wheel assemblies



Portable Sniffing Applications

Some applications require operators or technicians to look for leaks from a ladder, outdoors, above or below ground, or in a densely constructed industrial facility or power plant. In these cases, a mobile cart-mounted MSLD may not be practical. A truly portable unit such as the PHD-4 is required. Some examples of such applications are:

- Aircraft manufacturing and maintenance
- Power generating plants
- Pressurized pipelines
- Bioreactors and fermenters
- Petrochemical plants and refineries
- Underground tanks
- Large condensers or heat exchangers

Applications Table - General Guidelines for Leak Detection Methods and Equipment

The chart below is a general guide to assist you in determining which leak detector and test method is the correct solution for your application. This information should be used in conjunction with guidance from your Agilent Sales Engineer.

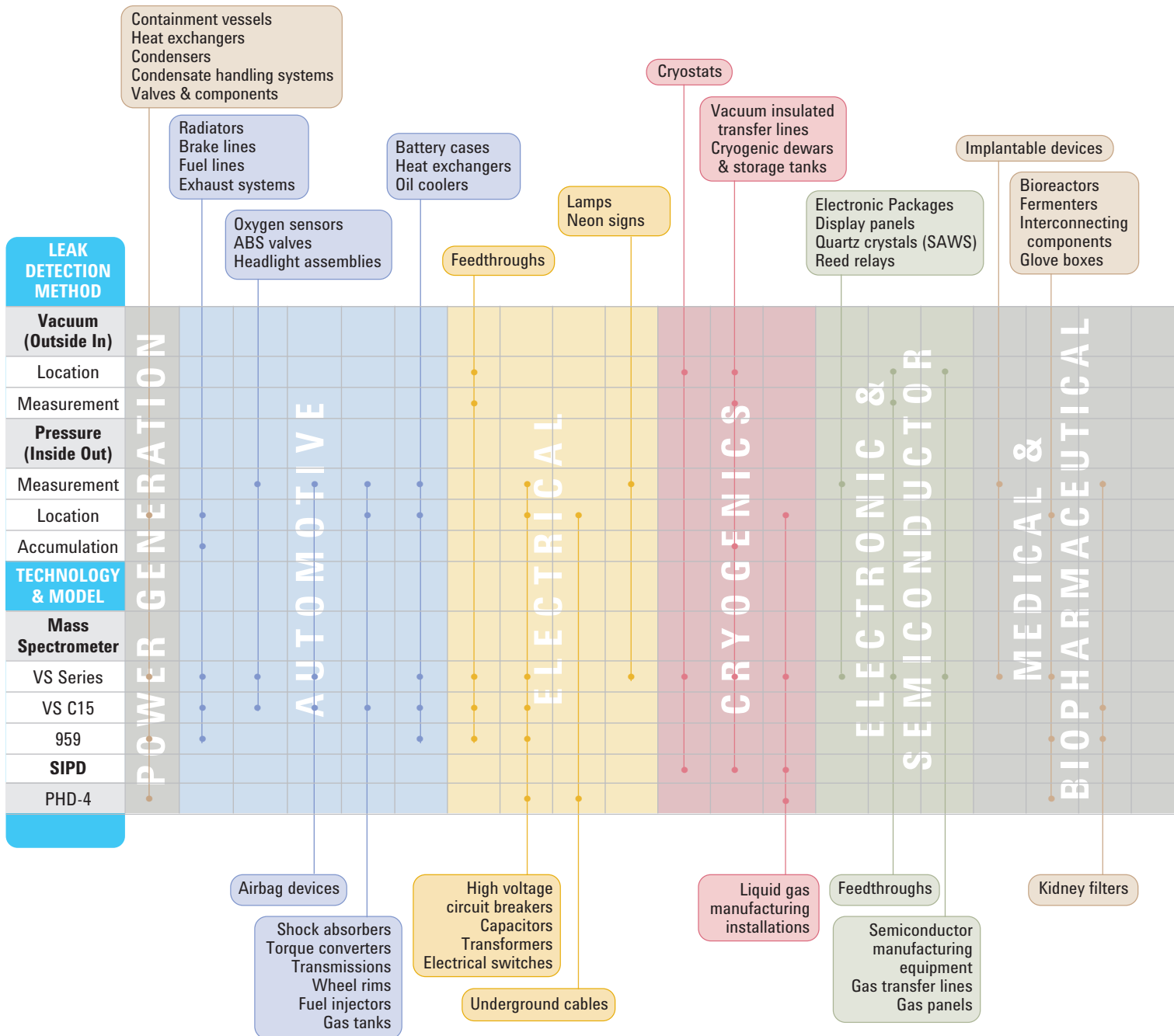

Leak Detection

To determine the appropriate leak detector for your application:

1. Find the colored column of table that relates to your application: Power Generation, Automotive, etc.
2. Find part(s) that are similar to your part to be tested. The parts are shown on the top and bottom of the table.
3. Find dots that indicate the suggested leak check method and equipment.

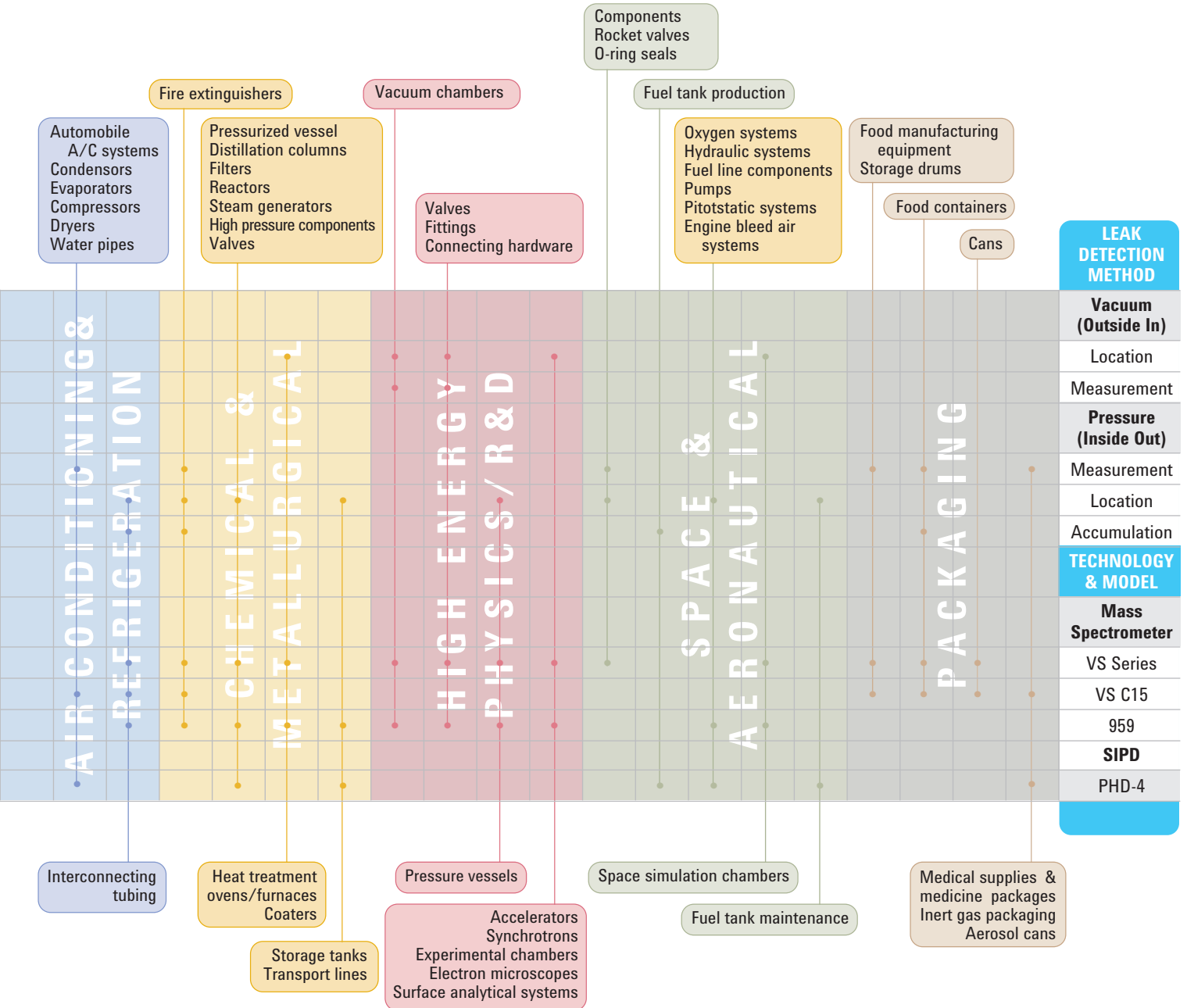

Design and Application Considerations

The Effect of Helium Pumping Speed

Detecting a leak quickly is one of the most important requirements in using a helium leak detector or a leak detection system. This requirement is characterized by the following elements:

- Response time
- Appearance time
- Disappearance (cleanup) time

1. Response time

Response time is defined as the time required for a leak detector to measure 63 % of the peak helium signal. This response time is based on an exponential behavior (Figure 1). This shows the appearance of a 10^{-7} std. cc/sec leak signal.

Figure 1 - Response Time

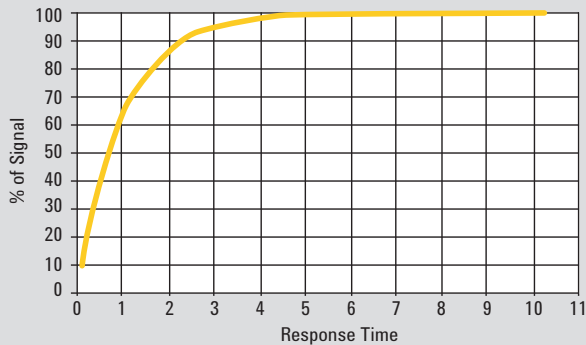

In order to quickly measure the signal in a vacuum application, the response time should be as short as possible. In general, a larger test volume will yield a slower response time. Also, a test volume connected to the detector by a long, narrow tube will negatively affect the response time, since helium must travel through the tube to the detector.

For a given volume, the effective pump speed of the leak detector or leak detection system must always be as large as possible. To optimize cycle time, for example in a production application, auxiliary pumps can be used to obtain the desired objectives. These pumps must be sized and correctly integrated to yield maximum effectiveness.

2. Appearance time

Appearance time is the time required to see an increase of signal, above the background level, after helium is admitted to a leak. Appearance time is only a first indication of a leak and does not indicate the eventual magnitude of the leak rate. This is different from response time, which is calculated from the peak value. The first "appearance" of a leak is often sufficient to stop a test cycle before a test chamber becomes saturated with helium, thus avoiding a lengthy cleanup period. In some applications, it is sufficient to know that there is a leak without knowing the actual magnitude of the leak

and the full response time. The outstanding background subtraction capabilities of Agilent's VS series helium leak detectors is of great importance in improving appearance time.

3. Disappearance time.

Disappearance time (cleanup time) is the time required for a leak detector to recover to a desired sensitivity after exposure to a leak. Here one will observe the most noticeable time difference between a high performance and low performance leak detection system arrangement. A high pumping speed will yield significantly faster cleanup times.

Selecting the Proper Connections

In most situations when using the Outside-in Vacuum Method, it is necessary to install a connection between the leak detector and the part or chamber to be evacuated. Sizing this connection is an important aspect of the leak detection system performance because, 1) the connection adds volume to the total system arrangement, and 2) it restricts the helium pumping capability of the leak detector system.

Selecting an inappropriate connection line can alter the capabilities of a leak detector system. For example, a tube of 4 feet in length by 0.40 inches in diameter has a conductance of 0.27 l/s for helium in molecular flow (Figure 2). This means that even the most powerful helium leak detector will not deliver a pumping speed higher than 0.27 l/s. Using this value in the calculations provided for response time, appearance time, and disappearance time will clearly demonstrate the impact of limited conductance.

Figure 2 - Conductance

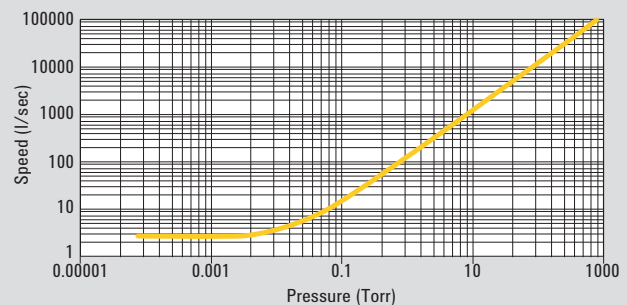

The Evacuation Process

In order to leak test a part by the Outside-in Vacuum Method, it is necessary to evacuate the part or the chamber in which the part is placed. The required vacuum level will depend on the acceptable leak rate requirements. (See section on helium background, page 39.)

Leak Detection

Figure 3 - Evacuation

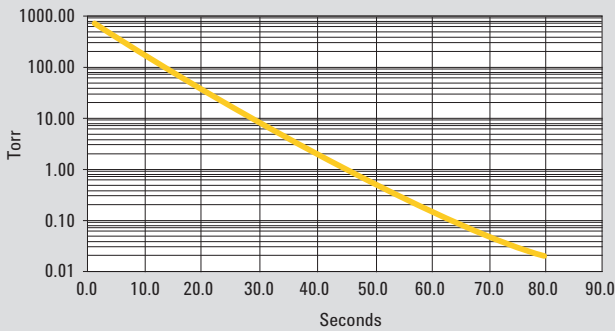

To reach the appropriate level in a timely fashion, it is necessary to select a pumping system based on the right pump characteristics, pumping speed and base pressure, as well as the right manifolds arrangement, conductance limitations and added volume considerations.

When purchasing a self contained helium leak detector that is equipped with its own roughing pump, special attention should be paid to the size of the pump to avoid the need for purchasing auxiliary pumps, manifold, or control equipment.

Appropriate Helium Background Conditions

As shown in Figure 4, helium is present in ambient air at 5 parts per million (ppm). Although this is a very low level when looking for leaks as small as 10^{-9} std. cc/sec, helium background remains an issue.

Figure 4

Gas	Symbol	% by Volume	PPM
Nitrogen	N ₂	78.08	780800
Oxygen	O ₂	20.95	209500
Argon	Ar	0.93	9300
Carbon Dioxide	CO ₂	0.03	300
Neon	Ne	0.0018	1
Helium	He	0.0005	5
Krypton	Kr	0.0001	1
Hydrogen	H ₂	0.00005	0.5
Xenon	Xe	0.0000087	0.087

When testing by the Outside-in Vacuum Method, correct evacuation conditions and proper spraying technique, combined with adequate ventilation, are key to maintaining proper detector system operation. Proper charging, venting and careful release of the helium after a test are critical in testing by the Inside-out Sniffing Method.

Agilent's VS series leak detectors are equipped with unique helium background suppression features that allow compensation of >2 decades of helium background (Floating Zero).

Parallel Operation

If the volume of the part to be tested is very large or the cycle time very short, an auxiliary pumping station may be required operating in parallel with the leak detector (see Figure 5). In this situation, the auxiliary pump or pumping station is used for roughing only.

Figure 5 - Parallel Operation

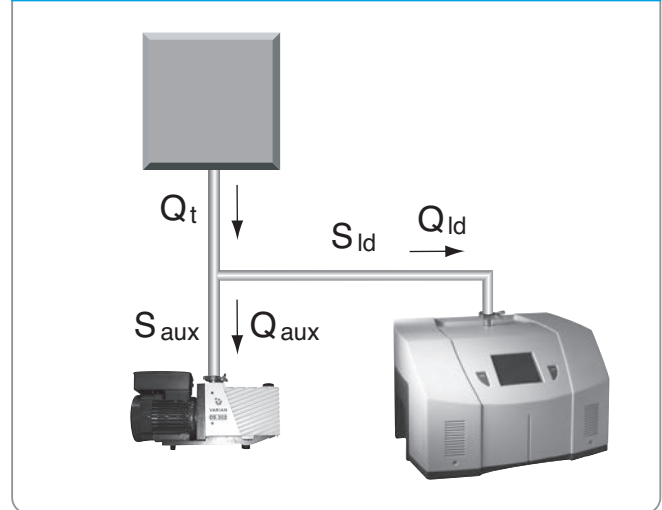

Calculation of response time, appearance time, and disappearance time must be considered in both the effective helium pumping speed provided by the detector and the effective helium pumping speed provided by the auxiliary pump at the chamber. The total helium flow (Q_t) coming through a leak and through the chamber will be split in a flow (Q_{ld}) towards the detector and flow (Q_{aux}) towards the auxiliary pump. This will result in a decrease of the indicated leak rate at the leak detector, for which must be compensation must be made.

Helium Consumption

Based on the attainable sensitivity using the helium leak detection method, parts to be tested may be charged with a helium/gas mixture to reduce the helium consumption. This is especially true for large parts or production type testing. Lower Helium consumption may also be achieved by raising the pressure inside the part to be tested, while lowering the concentration. The effect will vary depending on the flow conditions of the actual leak.

Equations for Use in Helium Leak Detection

Response time in molecular flow:

$$t_{63} = \frac{V}{S}$$

With: t = Time in seconds to 63% of full signal
 V = Volume in liters
 S = Helium pumping speed in l/s

Molecular flow conductance-circular tube (for N₂ at room temperature):

$$C = 12 \times \frac{D^3}{L}$$

With: C = Conductance in l/s
 D = Tube diameter in cm
 L = Tube length in cm

Appearance time in molecular flow:

$$t_a = \frac{V}{S} \times 2.3 \times \log \frac{Q}{Q - Q_m}$$

With: t_a = Appearance time in seconds
 V = Volume in liters
 S = Helium pumping speed of the detector in l/s
 Q = Leak rate in mbar.l/s
 Q_m = Smallest detectable leak in mbar.l/s

Split flow calculations:

$$(Q_{ld}) = \frac{(S_{ld})}{(S_{ld}) + (S_{aux})} \times (Q_t)$$

With: (Q_{ld}) = Helium flow towards the leak detector
 (Q_t) = Total helium flow from the chamber towards the LD + auxiliary pump
 (S_{ld}) = Helium pumping speed of the leak detector
 (S_{aux}) = Helium pumping speed of the auxiliary pump

Disappearance time in molecular flow:

$$t_d = \frac{V}{S} \times 2.3 \times \log \frac{Q}{Q - Q_m}$$

With: t_d = Disappearance time in seconds
 V = Volume in liters
 S = Helium pumping speed of the detector in liters/second
 Q = Leak rate in mbar l/sec
 Q_m = Smallest detectable leak in mbar.l/s

Gas loss under viscous flow conditions:

$$Q = \frac{R}{M} \times \frac{22400}{365 \times 24 \times 3600} \times \frac{T}{273}$$

With: Q = Leak rate in mbar l/s
 R = Gas loss in grams/year
 M = Molecular weight gas
 T = Temperature in degrees Kelvin
 22400 = Volume of one mole of gas at 273 °K and 1 atm in cc
 365 x 24 x 3600 = seconds in one year

Evacuation time:

$$t = \frac{V}{S} \times 2.3 \times \log \frac{P_1}{P_2}$$

With: t = Evacuation time in seconds
 V = Volume in liters
 S = Pumping speed in l/s
 P₁ = Beginning pressure in mbar
 P₂ = Ending pressure in mbar

Gas flow under viscous flow conditions:

$$Q = \frac{3.14 \times D^4}{256 \times \text{visc}} \times L \times (P_1^2 - P_2^2)$$

With: Q = Leak rate in mbar l/sec
 D = Leak diameter in cm
 L = Length of the leak in cm
 visc = viscosity of the gas in bar s
 P₁ = Absolute pressure one side of the wall in bar
 P₂ = Absolute pressure other side of the wall in bar

Viscous flow conductance-circular tube:

$$C = 182 \times \frac{D^4}{L} \times P$$

With: C = Conductance in l/s
 D = Tube diameter in cm
 L = Tube length in cm
 *P₁ = Upstream pressure in mbar
 *P₂ = Downstream pressure in mbar
 *P = average pressure (P⁰ + P_f)/2 in mbar

Gas flow under molecular flow conditions for long cylindrical tube:

$$Q = \frac{1}{6} \times \sqrt{\frac{2 \times 3.14 \times R \times T}{M}} \times \frac{D^3}{L} \times (P_1 - P_2)$$

With: Q = Leak rate in mbar l/sec
 L = Length of the leak in cm
 D = Leak diameter in cm
 M = Molecular weight gas
 R = Gas constant (8.3 E7)
 T = Temperature in degrees Kelvin
 P₁ = Absolute pressure one side of the wall in bar
 P₂ = Absolute pressure other side of the wall in bar

Pumping Speed

	cfm	l/minute	l/sec	m³/hour
1 cfm	1	28.32	0.472	1.6977
1 l/minute	0.035	1	0.016	0.06
1 l/sec	2.12	60	1	3.6
1 m ³ /hour	0.589	16.67	0.27	1

Flow/Leak Rate

	atm cc/sec	mbar l/sec	Torr l/sec	Pa m³/sec	sccm
1 atm cc/sec	1	1	0.76	0.1	60
1 mbar l/sec	1	1	0.76	0.1	60
1 Torr l/sec	1.3	1.3	1	0.13	80
1 Pa m ³ /sec	10	10	7.5	1	600
1 sccm	0.016	0.016	0.0125	0.0016	1

Pressure

	Torr	mbar	Pa	micron	psi	atm
1 Torr	1	1.33	133	1000	0.0193	0.00132
1 mbar	0.751	1	100	750	0.014	0.0009
1 Pa	0.00751	0.01	1	7.5	0.00014	0.000009
1 micron (mTorr)	0.001	0.0013	0.13	1	0.000019	0.0000013
1 psi	51.72	68.96	6896	51710	1	0.07
1 atm	760	1013	101300	760000	14.7	1

Volume

	inch³	ft³	liter	cm³	m³
1 inch ³	1	0.00056	0.0163	16.38	0.000016
1 ft ³	1728	1	28.316	28316	0.0283
1 liter	61.02	0.035	1	1000	0.001
1 cm ³	0.061	0.00003	0.001	1	0.000001
1 m ³	61023	35.33	1000	1000000	1